

# CDK3404

## 8-bit, 180MSPS, Triple Video DACs

CDK3404 8-bit, 180MSPS, Triple Video DACs Rev 3A

### FEATURES

- 8-bit resolution, 180MSPS
- ±2.5% gain matching
- ±0.5% linearity error
- Sync and blank controls
- 1.0V<sub>pp</sub> video into 37.5Ω or 75Ω load
- Internal bandgap voltage reference
- Low glitch energy
- Single +3.3V power supply

### APPLICATIONS

- Video signal conversion
  - RGB
  - YC<sub>B</sub>C<sub>R</sub>
  - Composite, Y, C
- Multimedia systems
- Image processing
- PC Graphics

### General Description

CDK3404 is a low-cost triple D/A converters that are tailored to fit graphics and video applications where speed is critical.

CMOS-level inputs are converted to analog current outputs that can drive 25-37.5Ω loads corresponding to doubly-terminated 50-75Ω loads. A sync current following SYNC input timing is added to the IO<sub>G</sub> output. BLANK will override RGB inputs, setting IO<sub>G</sub>, IO<sub>B</sub> and IO<sub>R</sub> currents to zero when BLANK = L. Although appropriate for many applications, the internal 1.25V reference voltage can be overridden by the V<sub>REF</sub> input.

Few external components are required, just the current reference resistor, current output load resistors, bypass capacitors, and decoupling capacitors.

Package is a 48-lead TQFP. Fabrication technology is CMOS. Performance is guaranteed from -40°C to +125°C.

### Block Diagram

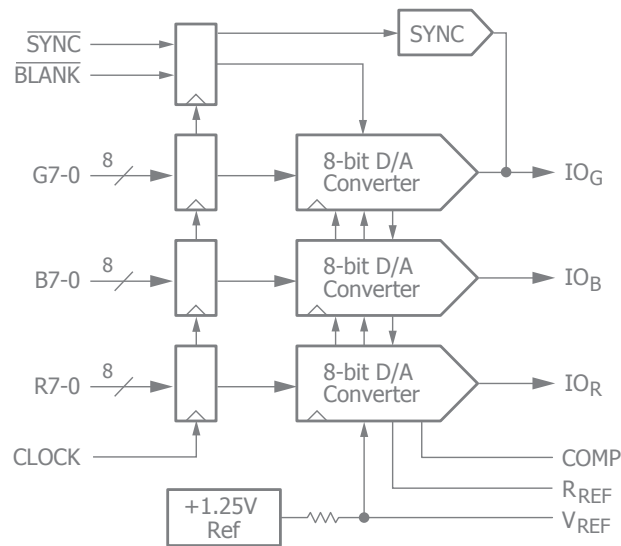

### Ordering Information

Part Number	Package	Pb-Free	RoHS Compliant	Operating Temp Range	Packaging Method	Package Quantity
CDK3404CTQ48	TQFP-48	Yes	Yes	-40°C to +125°C	Tray	250
CDK3404CTQ48Y	TQFP-48	Yes	Yes	-40°C to +125°C	Tray	1,250

Moisture sensitivity level for all parts is MSL-3.

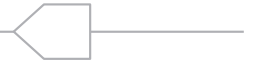

## Pin Configuration

### TQFP-48

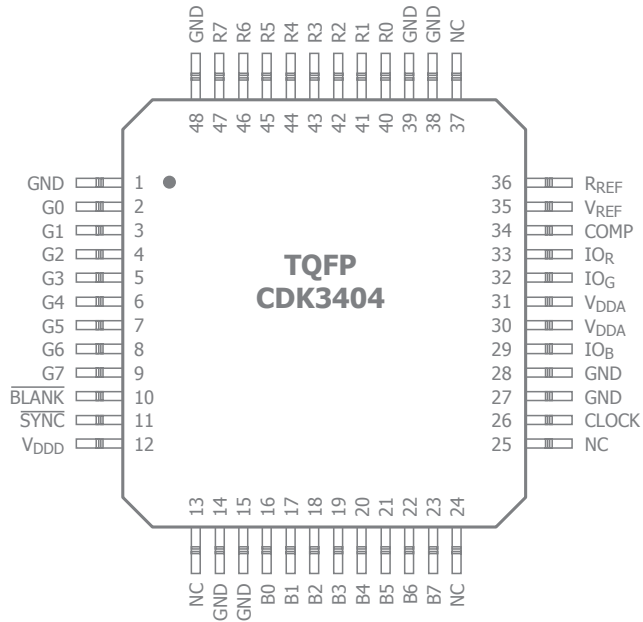

### Pin Assignments

Pin No.	Pin Name	Description
<b>Clock and Pixel I/O</b>		
26	CLK	Clock Input
47-40	R7-0	Red Pixel Data Inputs
9-2	G7-0	Green Pixel Data Inputs
23-16	B7-0	Blue Pixel Data Inputs
<b>Controls</b>		
11	$\overline{\text{SYNC}}$	Sync Pulse Input
10	$\overline{\text{BLANK}}$	Blanking Input
<b>Video Outputs</b>		
33	IOR	Red Current Output
32	IOG	Green Current Output
29	IOB	Blue Current Output
<b>Voltage Reference</b>		
35	V <sub>REF</sub>	Voltage Reference Output/Input
36	R <sub>REF</sub>	Current-Setting Resistor
34	COMP	Compensation Capacitor
<b>Power and Ground</b>		
30, 31	V <sub>DDA</sub>	Analog Power Supply
12	V <sub>DDD</sub>	Digital Power Supply
1, 14, 15, 27, 28, 38, 39, 48	GND	Ground
13, 24, 25, 37	NC	No Connect



## Absolute Maximum Ratings

The safety of the device is not guaranteed when it is operated above the "Absolute Maximum Ratings". The device should not be operated at these "absolute" limits. Adhere to the "Recommended Operating Conditions" for proper device function. The information contained in the Electrical Characteristics tables and Typical Performance plots reflect the operating conditions noted on the tables and plots.

Parameter	Min	Max	Unit
<b>Power Supply Voltage</b>			
V <sub>DDA</sub> (Measured to GND)	-0.5	4.0	V
V <sub>DDD</sub> (Measured to GND)	-0.5	4.0	V
<b>Digital Inputs</b>			
Applied Voltage (measured to GND) <sup>(2)</sup>	-0.5	V <sub>DDD</sub> + 0.5	V
Forced Current <sup>(3,4)</sup>	-5.0	5.0	mA
<b>Analog Inputs</b>			
Applied Voltage (measured to GND) <sup>(2)</sup>	-0.5	V <sub>DDA</sub> + 0.5	V
Forced Current <sup>(3,4)</sup>	-10.0	10.0	mA
<b>Analog Outputs</b>			
Applied Voltage (measured to GND) <sup>(2)</sup>	-0.5	V <sub>DD</sub> + 0.5	V
Forced Current <sup>(3,4)</sup>	-60.0	60.0	mA
Short Circuit Duration (single output in HIGH state to GND)		unlimited	sec

## Reliability Information

Parameter	Min	Max	Unit
<b>Temperature</b>			
Operating, Ambient	-40	125	°C
Junction		150	°C
Lead Soldering (10 seconds)		300	°C
Vapor Phase Soldering (1 minute)		220	°C
Storage	-65	150	°C
Package Thermal Resistance ( $\theta_{JA}$ )		65	°C/W

### Notes:

- Functional operation under any of these conditions is NOT implied. Performance and reliability are guaranteed only if Operating Conditions are not exceeded.
- Applied voltage must be current limited to specified range.
- Forcing voltage must be limited to specified range.
- Current is specified as conventional current flowing into the device.

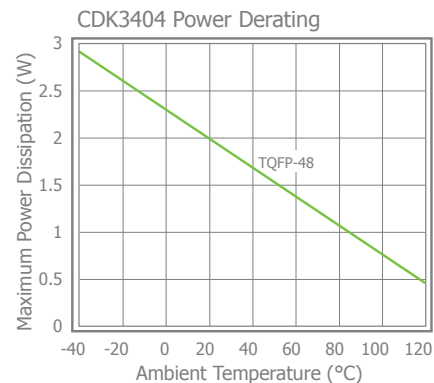

## Recommended Operating Conditions

Symbol	Parameter	Min	Typ	Max	Unit
V <sub>DD</sub>	Power Supply Voltage	3.0	3.3	3.6	V
V <sub>REF</sub>	Reference Voltage, External	1.0	1.25	1.5	V
C <sub>C</sub>	Compensation Capacitor		0.1		μF
R <sub>L</sub>	Output Load		37.5		Ω
T <sub>A</sub>	Ambient Temperature, Still Air	-40		+125	°C



## Electrical Characteristics

( $T_A = 25^\circ\text{C}$ ,  $V_{DDA} = V_{DDD} = 3.3\text{V}$ ,  $V_{REF} = 1.25\text{V}$ ,  $R_L = 37.5\Omega$ , unless otherwise noted)

Symbol	Parameter	Conditions	Min	Typ	Max	Units
$I_{DD}$	Power Supply Current	$T_A = 25^\circ\text{C}$ <sup>(1)</sup>		80	85	mA
		$T_A = -40^\circ\text{C}$ to $+125^\circ\text{C}$ <sup>(2)</sup>			95	mA
PD	Total Power Dissipation <sup>(2)</sup>	$T_A = -40^\circ\text{C}$ to $+125^\circ\text{C}$			300	mW
Digital Inputs						
$V_{IH}$	Input Voltage, HIGH <sup>(1)</sup>	$T_A = -40^\circ\text{C}$ to $+125^\circ\text{C}$	2.5			V
$V_{IL}$	Input Voltage, LOW <sup>(1)</sup>	$T_A = -40^\circ\text{C}$ to $+125^\circ\text{C}$			0.8	V
$I_{IH}$	Input Current, HIGH <sup>(1)</sup>	$T_A = -40^\circ\text{C}$ to $+125^\circ\text{C}$	-1		1	$\mu\text{A}$
$I_{IL}$	Input Current, LOW <sup>(1)</sup>	$T_A = -40^\circ\text{C}$ to $+125^\circ\text{C}$	-1		1	$\mu\text{A}$
$C_I$	Input Capacitance			4		pF
Analog Outputs						
	Output Current <sup>(1)</sup>				30	mA
$R_O$	Output Resistance			40		$\text{k}\Omega$
$C_O$	Output Capacitance			7		pF
Reference Output						
$V_{REF}$	Reference Voltage Output <sup>(1)</sup>	$T_A = -40^\circ\text{C}$ to $+125^\circ\text{C}$	1.135	1.25	1.365	V

### Notes:

- 100% tested at  $25^\circ\text{C}$ .
- Parameter is guaranteed (but not tested) by design and characterization data.

## Switching Characteristics

( $T_A = 25^\circ\text{C}$ ,  $V_{DDA} = V_{DDD} = 3.3\text{V}$ ,  $V_{REF} = 1.25\text{V}$ ,  $R_L = 37.5\Omega$ , unless otherwise noted)

Symbol	Parameter	Conditions	Min	Typ	Max	Units
Clock Input						
	Conversion Rate <sup>(1)</sup>	$T_A = -40^\circ\text{C}$ to $+125^\circ\text{C}$			180	MSPS
$t_{PWH}$	Pulse-width HIGH <sup>(2)</sup>	$T_A = -40^\circ\text{C}$ to $+125^\circ\text{C}$	2			ns
$t_{PWL}$	Pulse-width LOW <sup>(2)</sup>	$T_A = -40^\circ\text{C}$ to $+125^\circ\text{C}$	2			ns
Data Inputs						
$t_S$	Setup	$T_A = 25^\circ\text{C}$ <sup>(1)</sup>	1.5			ns
		$T_A = -40^\circ\text{C}$ to $+125^\circ\text{C}$ <sup>(2)</sup>	2			ns
$t_H$	Hold	$T_A = 25^\circ\text{C}$ <sup>(1)</sup>			0.6	ns
		$T_A = -40^\circ\text{C}$ to $+125^\circ\text{C}$ <sup>(2)</sup>			0.6	ns
Data Outputs, with $50\Omega$ doubly terminated load						
$t_D$	Clock to Output Delay	$T_A = -40^\circ\text{C}$ to $+125^\circ\text{C}$		1.6		ns
$t_R$	Output Risetime	$T_A = -40^\circ\text{C}$ to $+125^\circ\text{C}$		0.6		ns
$t_F$	Output Falltime	$T_A = -40^\circ\text{C}$ to $+125^\circ\text{C}$		0.4		ns
$t_{SET}$	Settling Time			2.5		ns
$t_{SKEW}$	Output Skew			0.3		ns

### Notes:

- 100% production tested at  $+25^\circ\text{C}$ .
- Parameter is guaranteed (but not tested) by design and characterization data.



## DC Performance

( $T_A = 25^\circ\text{C}$ ,  $V_{DDA} = V_{DDD} = 3.3\text{V}$ ,  $V_{REF} = 1.25\text{V}$ ,  $R_L = 37.5\Omega$ , unless otherwise noted)

Symbol	Parameter	Conditions	Min	Typ	Max	Units
	Resolution		8			bits
INL	Integral Linearity Error	$T_A = 25^\circ\text{C}$ <sup>(1)</sup>	-0.5		0.5	LSB
		$T_A = -40^\circ\text{C}$ to $+125^\circ\text{C}$ <sup>(2)</sup>	-0.5		0.5	LSB
DNL	Differential Linearity Error	$T_A = 25^\circ\text{C}$ <sup>(1)</sup>	-0.5		0.5	LSB
		$T_A = -40^\circ\text{C}$ to $+125^\circ\text{C}$ <sup>(2)</sup>	-0.5		0.5	LSB
	Offset Error	$T_A = -40^\circ\text{C}$ to $+125^\circ\text{C}$ <sup>(2)</sup>			0.01	%FS
	Gain Matching Error	$T_A = -40^\circ\text{C}$ to $+125^\circ\text{C}$ <sup>(1)</sup>	-2.5		2.5	%FS
	Absolute Gain Error	$T_A = -40^\circ\text{C}$ to $+125^\circ\text{C}$ <sup>(1)</sup>	-3.5		3.5	%FS
	Full-Scale Output Current	$T_A = 25^\circ\text{C}$ <sup>(1)</sup>	18.0	18.7	19.4	mA
		$T_A = -40^\circ\text{C}$ to $+125^\circ\text{C}$ <sup>(2)</sup>	18.0	18.7	19.4	mA
		$T_A = -40^\circ\text{C}$ to $+125^\circ\text{C}$ , With internal reference. Trim RSET to calibrate full-scale current.		18.7		mA
PSRR	Power Supply Rejection Ratio	$T_A = -40^\circ\text{C}$ to $+125^\circ\text{C}$ <sup>(2)</sup>	-0.01	0	0.01	%/%

### Notes:

- 100% production tested at  $+25^\circ\text{C}$ .
- Parameter is guaranteed (but not tested) by design and characterization data.

## AC Performance

( $T_A = 25^\circ\text{C}$ ,  $V_{DDA} = V_{DDD} = 3.3\text{V}$ ,  $V_{REF} = 1.25\text{V}$ ,  $R_L = 37.5\Omega$ , unless otherwise noted)

Symbol	Parameter	Conditions	Min	Typ	Max	Units
Analog Outputs						
	Glitch Energy			20		pVsec
	DAC-to-DAC Crosstalk			30		dB
	Data Feedthrough			50		dB
	Clock Feedthrough			60		dB

### Notes:

- 100% production tested at  $+25^\circ\text{C}$ .
- Parameter is guaranteed (but not tested) by design and characterization data.



Table 1. Output Voltage vs. Input Code,  $\overline{\text{SYNC}}$  and  $\overline{\text{BLANK}}$ ,  $V_{\text{REF}} = 1.25\text{V}$ ,  $R_{\text{REF}} = 348\Omega$ ,  $R_{\text{L}} = 37.5\Omega$

RGB7-0 (MSB...LSB)	BLUE AND RED			GREEN		
	$\overline{\text{SYNC}}$	$\overline{\text{BLANK}}$	$V_{\text{OUT}} \text{ (V)}$	$\overline{\text{SYNC}}$	$\overline{\text{BLANK}}$	$V_{\text{OUT}} \text{ (V)}$
1111 1111	1	1	0.700	1	1	1.007
1111 1111	0	1	0.700	0	1	0.700
1111 1110	1	1	0.697	1	1	1.004
1111 1101	1	1	0.659	1	1	1.001
•	•	•	•	•	•	•
•	•	•	•	•	•	•
1000 0000	1	1	0.351	1	1	0.658
0111 1111	1	1	0.349	1	1	0.656
0111 1111	0	1	0.349	0	1	0.349
•	•	•	•	•	•	•
•	•	•	•	•	•	•
0000 0010	1	1	0.005	1	1	0.312
0000 0001	1	1	0.003	1	1	0.310
0000 0000	1	1	0.000	1	1	0.307
0000 0000	0	1	0.000	0	1	0.000
XXXX XXXX	1	0	0.000	1	0	0.307
XXXX XXXX	0	0	0.000	0	0	0.000

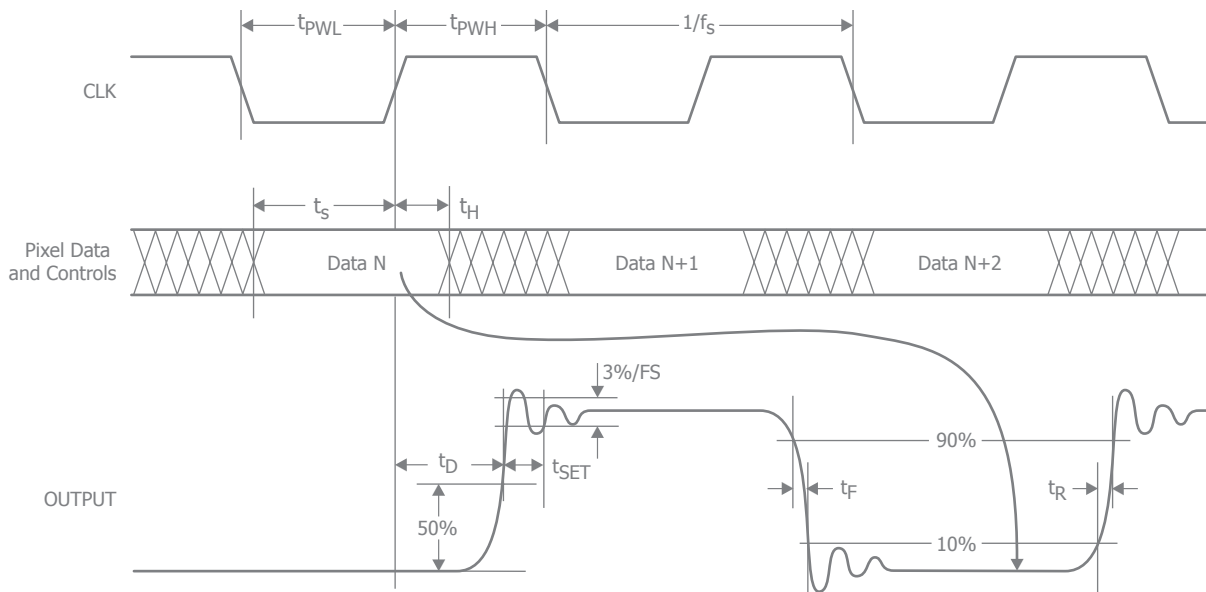

Figure 1. CDK3404 Timing Diagram



## Functional Description

Within the CDK3404 are three identical 8-bit D/A converters, each with a current source output. External loads are required to convert the current to voltage outputs. Data inputs RGB7-0 are overridden by the  $\overline{\text{BLANK}}$  input.  $\overline{\text{SYNC}}$  = H activates, sync current from  $I_{OS}$  for sync-on-green video signals.

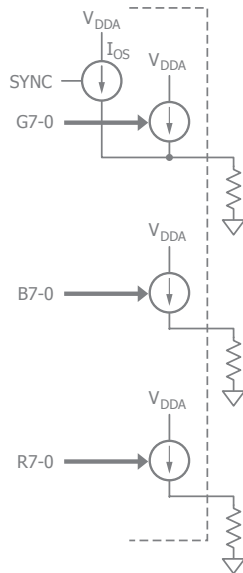

Figure 2. CDK3404 Current Source Structure

## Digital Inputs

Incoming GBR data is registered on the rising edge of the clock input, CLK. Analog outputs follow the rising edge of CLK after a delay,  $t_{DO}$ .

### Clock Input - CLK

Pixel data is registered on the rising edge of CLK. CLK should be driven by a dedicated buffer to avoid reflection induced jitter, overshoot, and undershoot.

### Pixel Data Inputs - R7-0, B7-0, G7-0

RGB digital inputs are registered on the rising edge of CLK.

## $\overline{\text{SYNC}}$ and $\overline{\text{BLANK}}$

$\overline{\text{SYNC}}$  and  $\overline{\text{BLANK}}$  inputs control the output level (Figure 3 and Table 1, on the previous page) of the D/A converters during CRT retrace intervals.  $\overline{\text{BLANK}}$  forces the D/A outputs to the blanking level while  $\overline{\text{SYNC}} = L$  turns off a current source,  $I_{OS}$ , that is connected to the green D/A converter.  $\overline{\text{SYNC}} = H$  adds a 112/256 fraction of full-scale current to the green output.  $\overline{\text{SYNC}} = L$  extinguishes the sync current during the sync tip.

$\overline{\text{BLANK}}$  gates the D/A inputs. If  $\overline{\text{BLANK}} = \text{HIGH}$ , the D/A inputs control the output currents to be added to the output blanking level. If  $\overline{\text{BLANK}} = \text{Low}$ , data inputs and the pedestal are disabled.

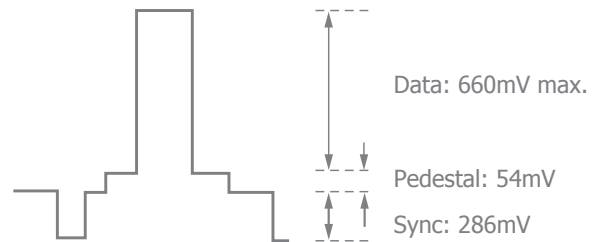

Figure 3. Normal Output Levels

### Sync Pulse Input - $\overline{\text{SYNC}}$

Bringing  $\overline{\text{SYNC}}$  LOW, disables a current source which superimposes a sync pulse on the  $I_{OG}$  output.  $\overline{\text{SYNC}}$  and pixel data are registered on the rising edge of CLK.  $\overline{\text{SYNC}}$  does not override any other data and should be used only during the blanking interval. If sync pulses are not required,  $\overline{\text{SYNC}}$  should be connected to GND.

### Blanking Input - $\overline{\text{BLANK}}$

When  $\overline{\text{BLANK}}$  is LOW, pixel data inputs are ignored and the D/A converter outputs are driven to the blanking level.  $\overline{\text{BLANK}}$  is registered on the rising edge of CLK.

## D/A Outputs

Each D/A output is a current source from the  $V_{DDA}$  supply. Expressed in current units, the GBR transformation from data to current is as follows:

$$G = G7-0 \ \& \ \overline{\text{BLANK}} + \overline{\text{SYNC}} * 112$$

$$B = B7-0 \ \& \ \overline{\text{BLANK}}$$

$$R = R7-0 \ \& \ \overline{\text{BLANK}}$$

Typical LSB current step is 73.2 $\mu\text{A}$ . To obtain a voltage output, a resistor must be connected to ground. Output voltage depends upon this external resistor, the reference voltage, and the value of the gain-setting resistor connected between  $R_{REF}$  and GND.

To implement a doubly-terminated 75 $\Omega$  transmission line, a shunt 75 $\Omega$  resistor should be placed adjacent to the analog output pin. With a terminated 75 $\Omega$  line connected to the analog output, the load on the CDK3404 current source is 37.5 $\Omega$ .

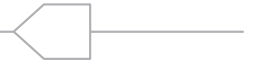

The CDK3404 may also be operated with a single 75Ω terminating resistor. To lower the output voltage swing to the desired range, the nominal value of the resistor on  $R_{REF}$  should be doubled.

### R, G, and B Current Outputs - $IO_R$ , $IO_G$ , $IO_B$

Current source outputs can drive VESA VSIS, and RS-343A/SMPTE-170M compatible levels into doubly-terminated 75Ω lines. Sync pulses can be added to the green output. When  $\overline{SYNC}$  is HIGH, the current added to  $IO_G$  is:

$$IO_S = 2.33 (V_{REF} / R_{REF})$$

### Current-Setting Resistor - $R_{REF}$

Full-scale output current of each D/A converter is determined by the value of the resistor connected between  $R_{REF}$  and GND. Nominal value of  $R_{REF}$  is found from:

$$R_{REF} = 5.31 (V_{REF} / I_{FS})$$

where  $I_{FS}$  is the full-scale (white) output current (in amps) from the D/A converter (without sync). Sync is  $0.439 * I_{FS}$ .

D/A full-scale (white) current may also be calculated from:

$$I_{FS} = V_{FS} / R_L$$

Where  $V_{FS}$  is the white voltage level and  $R_L$  is the total resistive load (Ω) on each D/A converter.  $V_{FS}$  is the blank to full-scale voltage.

### Voltage Reference

Full scale current is a multiple of the current  $I_{SET}$  through an external resistor,  $R_{SET}$  connected between the  $R_{REF}$  pin

and GND. Voltage across  $R_{SET}$  is the reference voltage,  $V_{REF}$ , which can be derived from either the 1.25 volt internal bandgap reference or an external voltage reference connected to  $V_{REF}$ . To minimize noise, a 0.1μF capacitor should be connected between  $V_{REF}$  and ground.  $I_{SET}$  is mirrored to each of the GBR output current sources. To minimize noise, a 0.1μF capacitor should be connected between the COMP pin and the analog supply voltage  $V_{DDA}$ .

### Voltage Reference Output/Input - $V_{REF}$

An internal voltage source of +1.25V is output on the  $V_{REF}$  pin. An external +1.25V reference may be applied to override the internal reference. Decoupling  $V_{REF}$  to GND with a 0.1μF ceramic capacitor is required.

### Power and Ground

Required power is a single +3.3V supply. To minimize power supply induced noise, analog +3.3V should be connected to  $V_{DDD}$  and  $V_{DDA}$  pins with 0.1μF and 0.01μF decoupling capacitors placed adjacent to each  $V_{DD}$  pin or pin pair.

The high slew-rate of digital data makes capacitive coupling to the outputs of any D/A converter a potential problem. Since the digital signals contain high-frequency components of the CLK signal, as well as the video output signal, the resulting data feedthrough often looks like harmonic distortion or reduced signal-to-noise performance. All ground pins should be connected to a common solid ground plane for best performance.



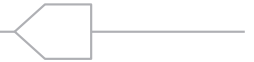

## Applications Discussion

Figure 5 (on the following page) illustrates a typical CDK3404 interface circuit. In this example, an optional 1.2V band-gap reference is connected to the  $V_{REF}$  output, overriding the internal voltage reference source.

## Grounding

It is important that the CDK3404 power supply is well-regulated and free of high-frequency noise. Careful power supply decoupling will ensure the highest quality video signals at the output of the circuit. The CDK3404 has separate analog and digital circuits. To keep digital system noise from the D/A converter, it is recommended that power supply voltages come from the system analog power source and all ground connections (GND) be made to the analog ground plane. Power supply pins should be individually decoupled at the pin.

## Printed Circuit Board Layout

Designing with high-performance mixed-signal circuits demands printed circuits with ground planes. Overall system performance is strongly influenced by the board layout. Capacitive coupling from digital to analog circuits may result in poor D/A conversion. Consider the following suggestions when doing the layout:

1. Keep the critical analog traces ( $V_{REF}$ ,  $I_{REF}$ , COMP,  $IO_S$ ,  $IO_R$ ,  $IO_G$ ) as short as possible and as far as possible from all digital signals. The CDK3404 should be located near the board edge, close to the analog output connectors.
2. The power plane for the CDK3404 should be separate from that which supplies the digital circuitry. A single power plane should be used for all of the  $V_{DD}$  pins. If the power supply for the CDK3404 is the same as that of the system's digital circuitry, power to the CDK3404 should be decoupled with 0.1 $\mu$ F and 0.01 $\mu$ F capacitors and isolated with a ferrite bead.
3. The ground plane should be solid, not cross-hatched. Connections to the ground plane should have very short leads.

4. If the digital power supply has a dedicated power plane layer, it should not be placed under the CDK3404, the voltage reference, or the analog outputs. Capacitive coupling of digital power supply noise from this layer to the CDK3404 and its related analog circuitry can have an adverse effect on performance.

5. CLK should be handled carefully. Jitter and noise on this clock will degrade performance. Terminate the clock line carefully to eliminate overshoot and ringing.

## Improved Transition Times

Output shunt capacitance dominates slowing of output transition times, whereas series inductance causes a small amount of ringing that affects overshoot and settling time. With a doubly terminated 75 $\Omega$  load, transition times can be improved by matching the capacitive impedance output of the CDK3404. Output capacitance can be matched with a 220nH inductor in series with the 75 $\Omega$  source termination.

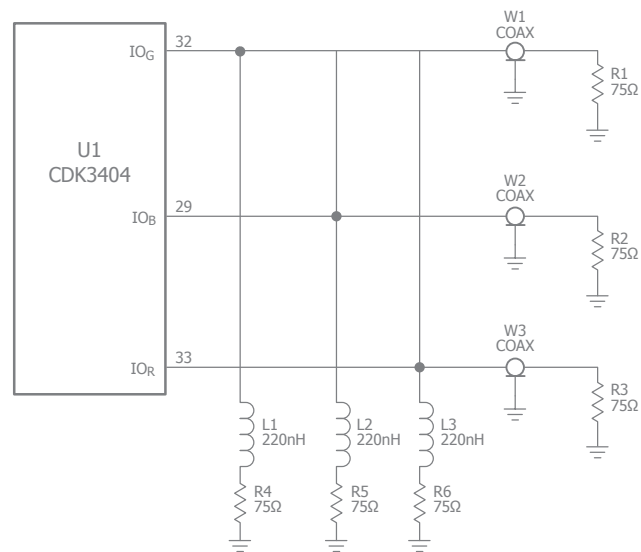

Figure 4. Schematic, Transition Time Sharpening Circuit

A 220nH inductor trims the performance of a 4ft cable, quite well. In Figures xx through xx, the glitch at 12.5ns, is due to a reflection from the source. Not shown, are smaller glitches at 25 and 37.5ns, corresponding to secondary and tertiary reflections. Inductor values should be selected to match the length and type of the cable.

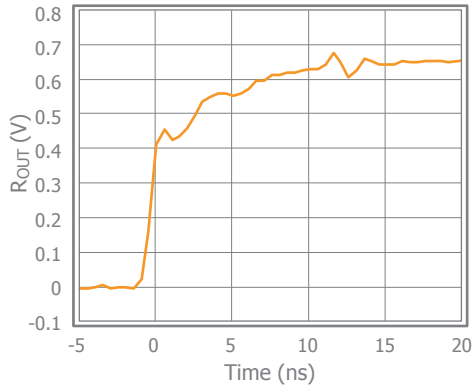

Figure 5. Unmatched  $t_R$

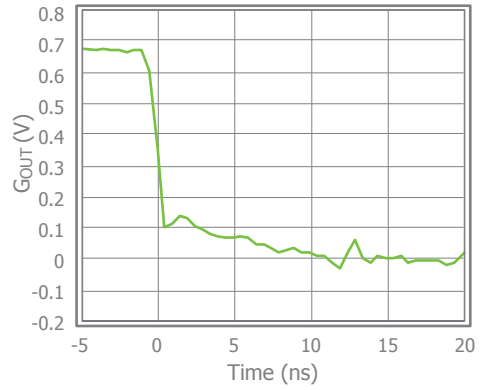

Figure 7. Unmatched  $t_F$

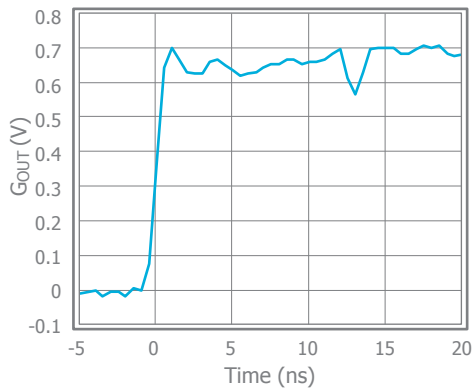

Figure 6. Matched  $t_R$

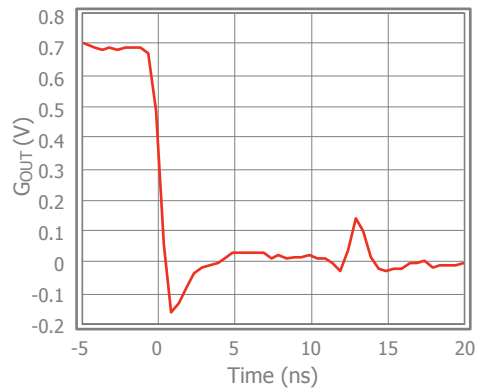

Figure 8. Matched  $t_F$

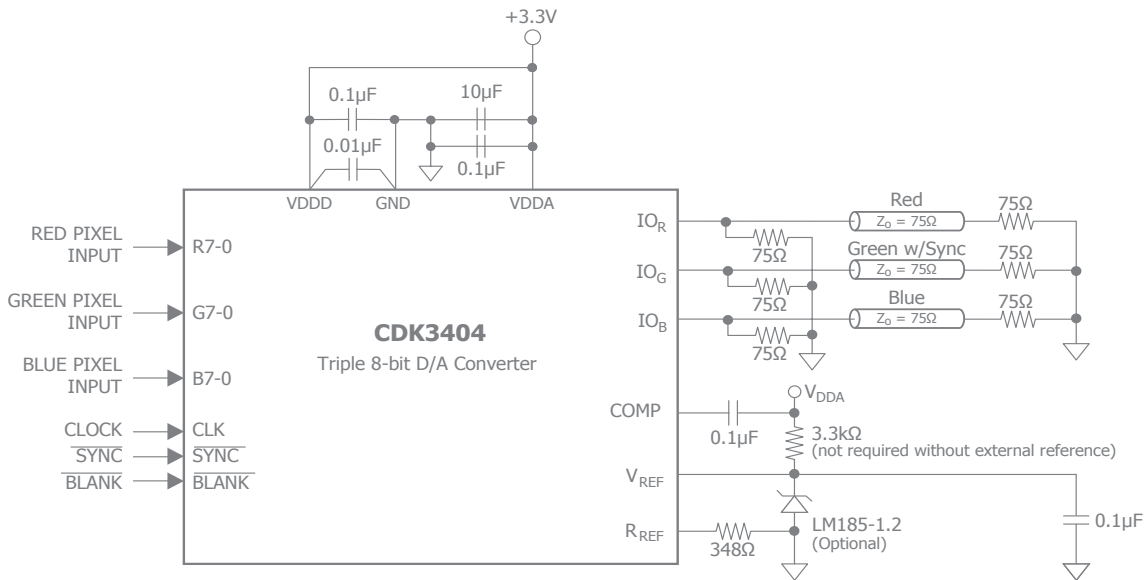
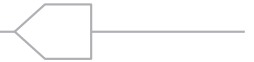

Figure 9. Typical Interface Circuit Diagram

Evaluation boards are available (CEB3400), contact CADEKA for more information.

### Related Products

- CDK3400/3401 Triple 10-bit 180MSPS DACs
- CDK3404 Triple 8-bit 180MSPS DAC



## Mechanical Dimensions

### LQFP-48 Package

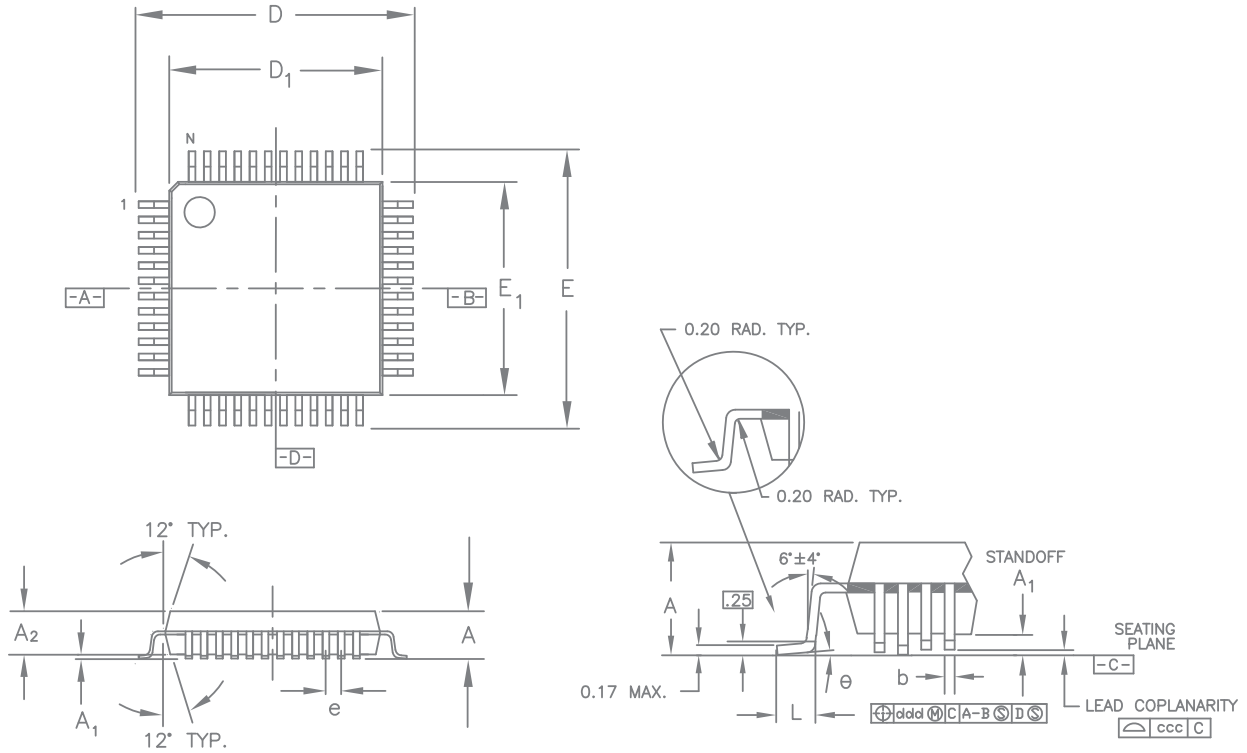

LEAD COUNT		48L	
DIMS.	TOL.		
A	MAX.	1.20	1.60
A <sub>1</sub>		.05 MIN.	.15 MAX.
A <sub>2</sub>	±.05	1.00	1.40
D	±.20	9.00	
D <sub>1</sub>	±.10	7.00	
E	±.20	9.00	
E <sub>1</sub>	±.10	7.00	
L	+.15/- .10	.60	
e	BASIC	.50	
φ	±.05	.22	
θ		0°-7°	
ddd	MAX.	.08	
ccc	MAX.	.08	
JEDEC REFERENCE DRAWING		MS-026	MS-026
VARIATION DESIGNATOR		ABC	BBC

#### NOTES.

1. All dimensions in mm.
2. Dimension shown are nominal with tolerances indicated.
3. Foot length 'L' is measured at gage plane 0.25mm above seating plane.
4. L/F: Etefc 64T Cu or equivalent, 0.127mm (0.005") thick

For additional information regarding our products, please visit CADEKA at: [cadeka.com](http://cadeka.com)

CADEKA Headquarters Loveland, Colorado  
 T: 970.663.5452  
 T: 877.663.5452 (toll free)

CADEKA, the CADEKA logo design, COMLINEAR and the COMLINEAR logo design are trademarks or registered trademarks of CADEKA Microcircuits LLC. All other brand and product names may be trademarks of their respective companies.

CADEKA reserves the right to make changes to any products and services herein at any time without notice. CADEKA does not assume any responsibility or liability arising out of the application or use of any product or service described herein, except as expressly agreed to in writing by CADEKA; nor does the purchase, lease, or use of a product or service from CADEKA convey a license under any patent rights, copyrights, trademark rights, or any other of the intellectual property rights of CADEKA or of third parties.

Copyright ©2009 by CADEKA Microcircuits LLC. All rights reserved.

