

BGA6589

MMIC wideband medium power amplifier

Rev. 02 — 25 May 2009

Product data sheet

1. Product profile

1.1 General description

The BGA6589 is a silicon Monolithic Microwave Integrated Circuit (MMIC) wideband medium power amplifier with internal matching circuit in a 3-pin SOT89 plastic low thermal resistance SMD package.

The BGA6x89 series of medium power gain blocks are resistive feedback Darlington configured amplifiers. Resistive feedback provides large bandwidth with high accuracy.

CAUTION



This device is sensitive to ElectroStatic Discharge (ESD). Therefore care should be taken during transport and handling.

1.2 Features

- Broadband 50 Ω gain block
- 20 dBm output power
- SOT89 package
- Single supply voltage needed

1.3 Applications

- Broadband medium power gain blocks
- Small signal high linearity amplifiers
- Variable gain and high output power in combination with the BGA2031
- Cellular, PCS and CDPD
- IF/RF buffer amplifier
- Wireless data SONET
- Oscillator amplifier, final PA
- Drivers for CATV amplifier

1.4 Quick reference data

Table 1. Quick reference data

Symbol	Parameter	Conditions	Min	Typ	Max	Unit
V_D	DC device voltage	on pin 1; $I_S = 81$ mA	-	4.8	-	V
I_S	DC supply current	$V_S = 9$ V; $R_{bias} = 51$ Ω ; $T_j = 25$ °C	-	81	-	mA
$ S_{21} ^2$	insertion power gain	$f = 1950$ MHz	-	17	-	dB
NF	noise figure	$f = 1950$ MHz	-	3.3	-	dB
P_{L1dB}	load power at 1 dB gain compression	$f = 850$ MHz	-	21	-	dBm
		$f = 1950$ MHz	-	20	-	dBm

2. Pinning information

Table 2. Pinning

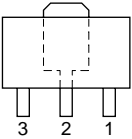
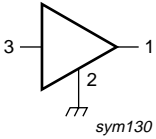
Pin	Description	Simplified outline	Graphic symbol
1	RF_OUT/BIAS		 sym130
2	GND		
3	RF_IN		

3. Ordering information

Table 3. Ordering information

Type number	Package		
	Name	Description	Version
BGA6589	SC-62	plastic surface-mounted package; collector pad for good heat transfer; 3 leads	SOT89

4. Marking

Table 4. Marking codes

Type number	Marking code
BGA6589	5A

5. Limiting values

Table 5. Limiting values

In accordance with the Absolute Maximum Rating System (IEC 60134).

Symbol	Parameter	Conditions	Min	Max	Unit
V_D	DC device voltage	on pin 1; RF input AC coupled	-	6	V
I_S	DC supply current		-	150	mA
P_{tot}	total power dissipation	$T_{sp} \leq 70\text{ °C}$	[1]	800	mW
T_{stg}	storage temperature		-65	+150	°C
T_j	junction temperature		-	150	°C
P_D	drive power		-	15	dBm

[1] T_{sp} is the temperature at the solder point of the ground lead, pin 2.

6. Thermal characteristics

Table 6. Thermal characteristics

Symbol	Parameter	Conditions	Typ	Unit	
$R_{th(j-sp)}$	thermal resistance from junction to solder point	$T_{sp} \leq 70\text{ °C}$	[1]	100	K/W

[1] T_{sp} is the temperature at the solder point of the ground lead, pin 2.

7. Characteristics

Table 7. Static characteristics

$V_S = 9\text{ V}$; $T_j = 25\text{ °C}$; $R_{bias} = 51\ \Omega$. [1]

Symbol	Parameter	Conditions	Min	Typ	Max	Unit
V_D	DC device voltage	on pin 1; $I_S = 81\text{ mA}$	-	4.8	-	V
I_S	DC supply current		73	81	89	mA

[1] V_S = DC operating supply voltage applied to R_{bias} ; see [Figure 10](#).

Table 8. Characteristics

$V_S = 9\text{ V}$; $I_S = 81\text{ mA}$; $T_{amb} = 25\text{ °C}$; $R_{bias} = 51\ \Omega$; $IP3_{(out)}$ tone spacing = 1 MHz; $P_L = 0\text{ dBm}$ per tone (see [Figure 10](#)); $Z_L = Z_S = 50\ \Omega$; unless otherwise specified.

Symbol	Parameter	Conditions	Min	Typ	Max	Unit
$ S_{21} ^2$	insertion power gain	f = 850 MHz	-	22	-	dB
		f = 1950 MHz	-	17	-	dB
		f = 2500 MHz	-	15	-	dB
R_{LIN}	return losses input	f = 850 MHz	-	9	-	dB
		f = 1950 MHz	-	11	-	dB
		f = 2500 MHz	-	15	-	dB
R_{LOUT}	return losses output	f = 850 MHz	-	10	-	dB
		f = 1950 MHz	-	13	-	dB
		f = 2500 MHz	-	13	-	dB

Table 8. Characteristics ...continued

$V_S = 9\text{ V}$; $I_S = 81\text{ mA}$; $T_{amb} = 25^\circ\text{C}$; $R_{bias} = 51\ \Omega$; $IP3_{(out)}$ tone spacing = 1 MHz; $P_L = 0\text{ dBm}$ per tone (see Figure 10); $Z_L = Z_S = 50\ \Omega$; unless otherwise specified.

Symbol	Parameter	Conditions	Min	Typ	Max	Unit
NF	noise figure	f = 850 MHz	-	3.0	-	dB
		f = 1950 MHz	-	3.3	-	dB
		f = 2500 MHz	-	3.4	-	dB
K	stability factor	f = 850 MHz	-	1.1	-	
		f = 2500 MHz	-	1.1	-	
P_{L1dB}	load power at 1 dB gain compression	f = 850 MHz	-	21	-	dBm
		f = 1950 MHz	-	20	-	dBm
$IP3_{(in)}$	input intercept point	f = 850 MHz	-	11	-	dBm
		f = 2500 MHz	-	15	-	dBm
$IP3_{(out)}$	output intercept point	f = 850 MHz	-	33	-	dBm
		f = 2500 MHz	-	30	-	dBm

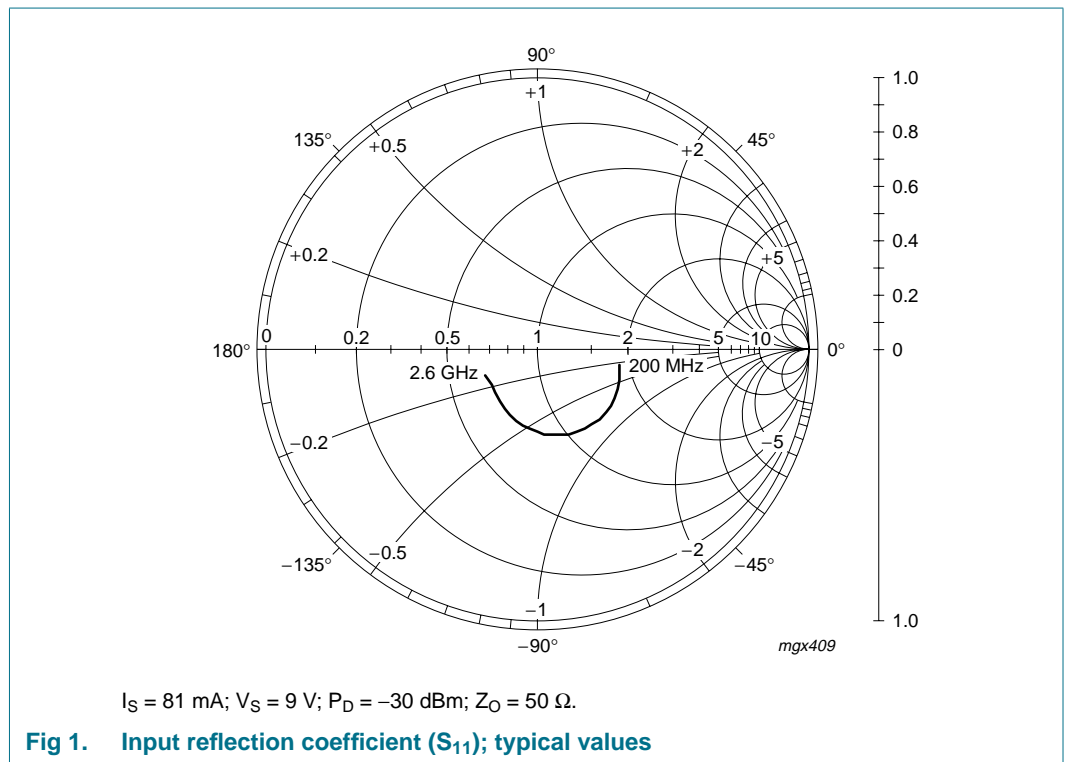

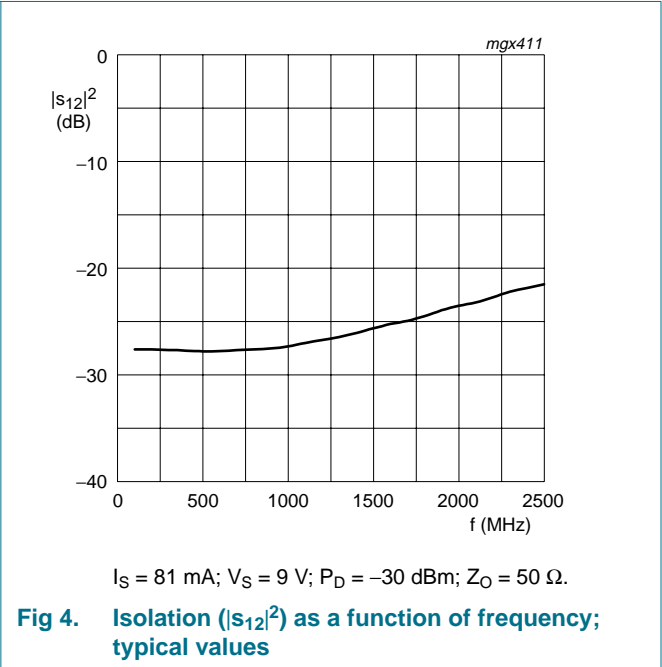
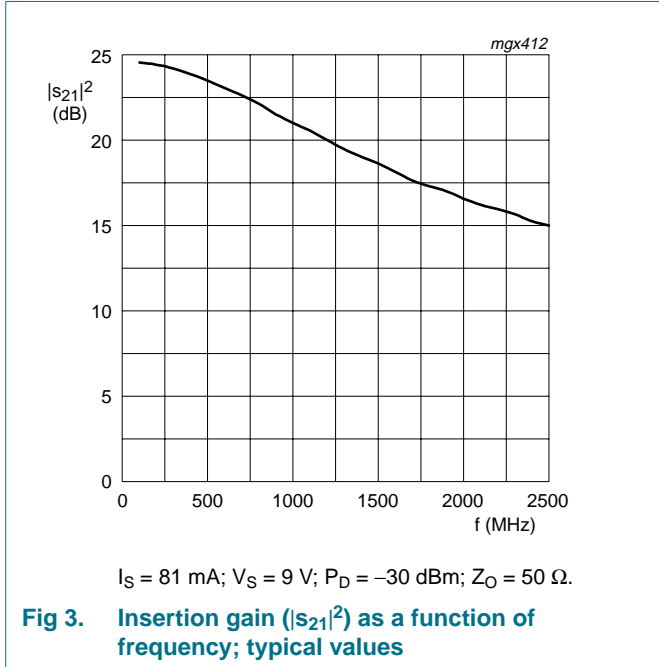
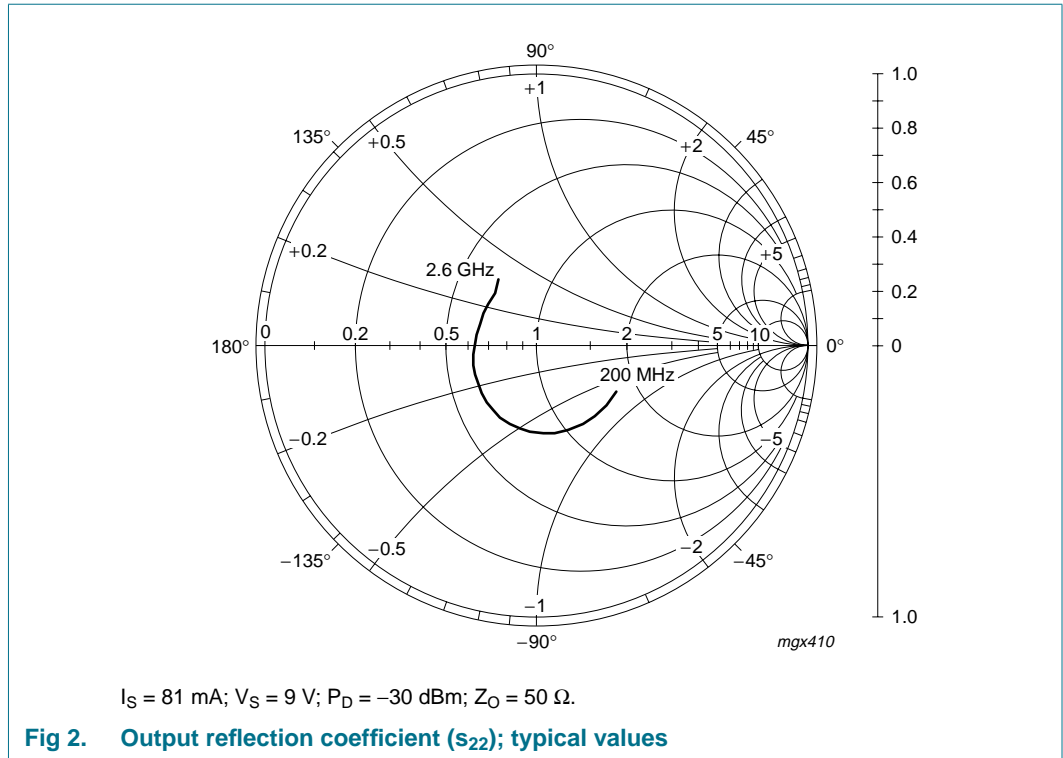

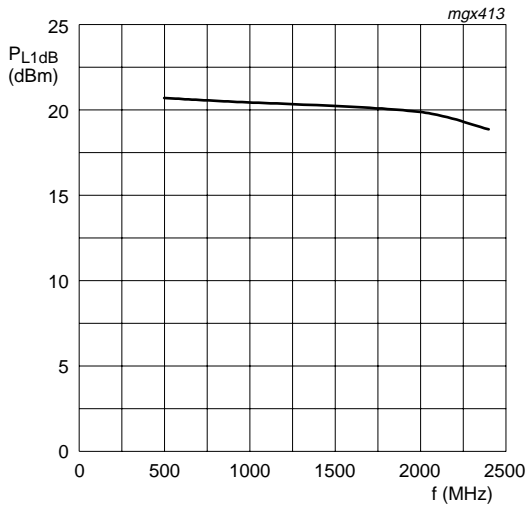

$I_S = 81 \text{ mA}$; $V_S = 9 \text{ V}$; $Z_O = 50 \Omega$.

Fig 5. Load power as a function of frequency; typical values

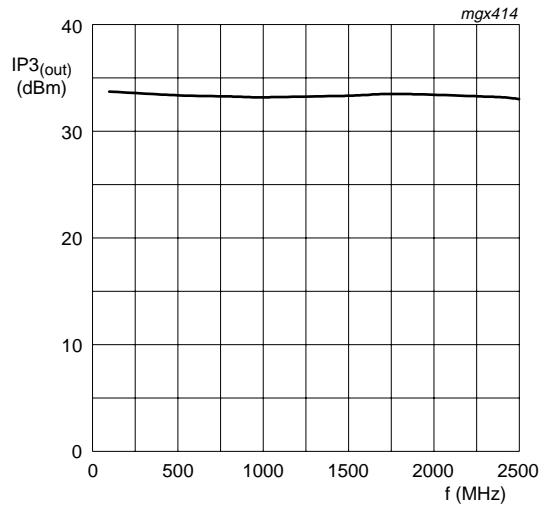

$I_S = 81 \text{ mA}$; $V_S = 9 \text{ V}$; $P_L = 0 \text{ dBm}$; $Z_O = 50 \Omega$.

Fig 6. Output intercept as a function of frequency; typical values

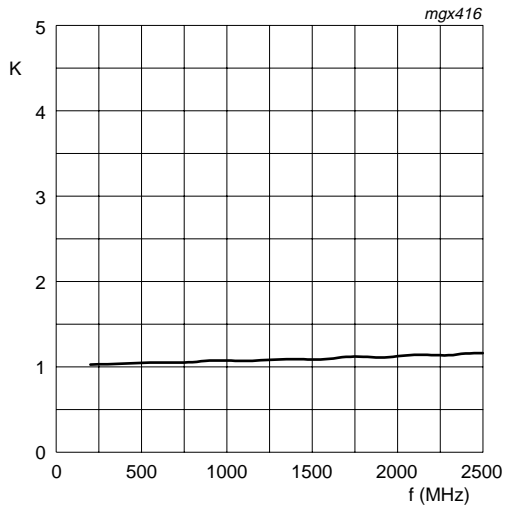

$I_S = 81 \text{ mA}$; $V_S = 9 \text{ V}$; $Z_O = 50 \Omega$.

Fig 7. Stability factor as a function of frequency; typical values

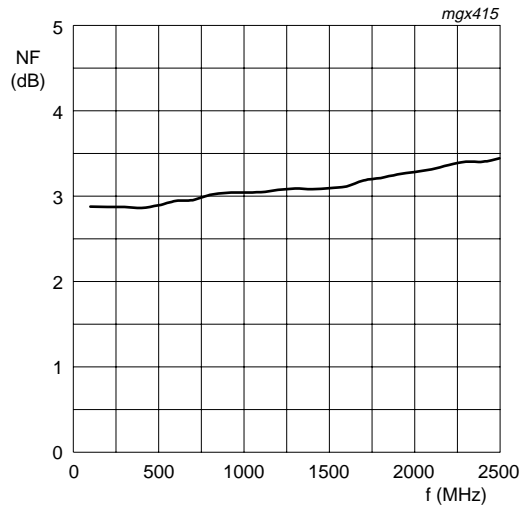

$I_S = 81 \text{ mA}$; $V_S = 9 \text{ V}$; $Z_O = 50 \Omega$.

Fig 8. Noise figure as a function of frequency; typical values

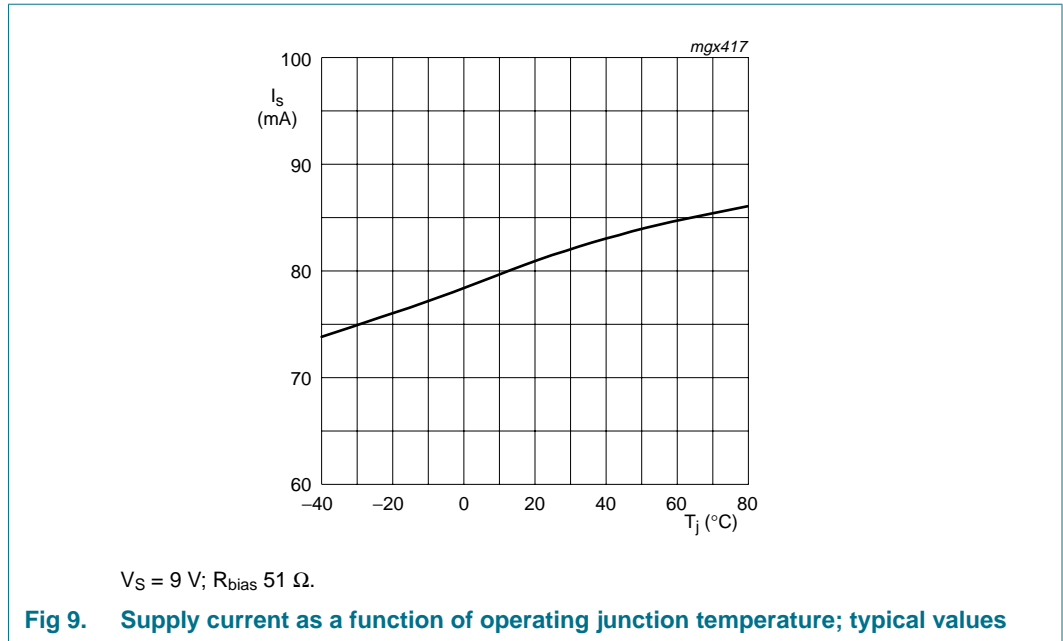

8. Application information

Figure 10 shows a typical application circuit for the BGA6589 MMIC. The device is internally matched to $50\ \Omega$, and therefore does not require any external matching. The value of the input and output DC blocking capacitors C1 and C2 depends on the operating frequency; see Table 9. Capacitors C1 and C2 are used in conjunction with L1 and C3 to fine tune the input and output impedance. Capacitor C4 is a supply decoupling capacitor. A $1\ \mu\text{F}$ capacitor (C5) can be added for optimum supply decoupling. The external components should be placed as close as possible to the MMIC. When using via holes, use multiple via holes per pin in order to limit ground path induction. Resistor R1 is a bias resistor providing DC current stability with temperature.

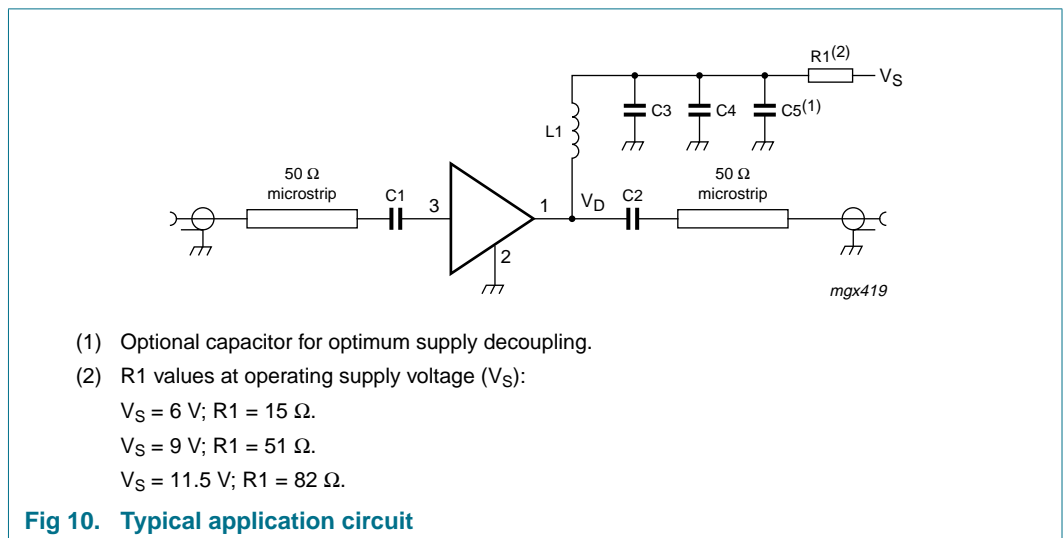

Table 9. List of components

See [Figure 10](#) for circuit.

Component	Description	Type	Value at operating frequency				
			500 MHz	800 MHz	1950 MHz	2400 MHz	3500 MHz
C1, C2	multilayer ceramic chip capacitor	0603	220 pF	100 pF	68 pF	56 pF	39 pF
C3	multilayer ceramic chip capacitor	0603	100 pF	68 pF	22 pF	22 pF	15 pF
C4	multilayer ceramic chip capacitor	0603	1 nF	1 nF	1 nF	1 nF	1 nF
C5 ^[1]	electrolytic or tantalum capacitor	0603	1 μF	1 μF	1 μF	1 μF	1 μF
L1	SMD inductor	0603	68 nH	33 nH	22 nH	18 nH	15 nH
R1	SMD resistor, 0.5 W; $V_S = 9\text{ V}$	-	51 Ω	51 Ω	51 Ω	51 Ω	51 Ω

[1] Optional.

Table 10. Scattering parameters

$I_S = 81\text{ mA}$; $V_S = 9\text{ V}$; $P_D = -30\text{ dBm}$; $Z_O = 50\text{ Ω}$; $T_{amb} = 25\text{ °C}$.

f (MHz)	S ₁₁		S ₂₁		S ₁₂		S ₂₂		K factor
	Magnitude (ratio)	Angle (degree)	Magnitude (ratio)	Angle (degree)	Magnitude (ratio)	Angle (degree)	Magnitude (ratio)	Angle (degree)	
200	0.30	-6.87	16.61	161.86	0.04	2.38	0.34	-20.03	1.0
300	0.31	-10.91	16.18	153.02	0.04	3.66	0.34	-30.50	1.0
400	0.32	-15.72	15.59	144.39	0.04	5.17	0.34	-40.74	1.1
500	0.33	-21.0	14.91	136.01	0.04	6.75	0.34	-50.56	1.1
600	0.33	-26.44	14.19	128.12	0.04	8.67	0.34	-60.07	1.1
700	0.34	-32.08	13.51	120.88	0.04	10.94	0.33	-69.21	1.1
800	0.34	-37.75	12.77	114.19	0.04	13.65	0.33	-77.91	1.1
900	0.35	-43.18	11.88	107.40	0.04	15.15	0.32	-86.13	1.1
1000	0.35	-48.9	11.22	101.34	0.04	17.89	0.32	-94.01	1.1
1100	0.35	-54.2	10.64	95.86	0.04	19.93	0.31	-101.7	1.1
1200	0.35	-59.55	10.0	90.82	0.05	22.11	0.30	-109.1	1.1
1300	0.34	-64.78	9.39	85.46	0.05	24.10	0.30	-116.4	1.1
1400	0.34	-69.93	8.93	80.15	0.05	24.62	0.29	-123.6	1.1
1500	0.33	-74.81	8.54	75.95	0.05	25.98	0.28	-130.9	1.1
1600	0.33	-79.82	8.07	72.26	0.05	27.67	0.27	-138.2	1.1
1700	0.32	-84.88	7.60	67.95	0.06	28.69	0.26	-145.7	1.1
1800	0.31	-89.81	7.32	63.43	0.06	28.33	0.25	-153.6	1.1
1900	0.30	-94.89	7.08	59.81	0.06	28.44	0.24	-162.0	1.1
2000	0.29	-100.3	6.74	56.09	0.07	29.27	0.23	-170.7	1.1
2100	0.28	-105.9	6.46	51.84	0.07	29.17	0.23	179.99	1.1
2200	0.26	-111.8	6.28	48.02	0.07	28.46	0.22	170.17	1.2
2300	0.25	-118.0	6.07	45.0	0.08	28.37	0.22	160.16	1.2
2400	0.24	-125.2	5.78	41.33	0.08	28.17	0.22	149.59	1.1

Table 10. Scattering parameters ...continued $I_S = 81 \text{ mA}$; $V_S = 9 \text{ V}$; $P_D = -30 \text{ dBm}$; $Z_O = 50 \Omega$; $T_{amb} = 25 \text{ }^\circ\text{C}$.

f (MHz)	S ₁₁		S ₂₁		S ₁₂		S ₂₂		K factor
	Magnitude (ratio)	Angle (degree)	Magnitude (ratio)	Angle (degree)	Magnitude (ratio)	Angle (degree)	Magnitude (ratio)	Angle (degree)	
2500	0.22	-132.8	5.61	36.72	0.08	26.46	0.23	139.39	1.2
2600	0.21	-141.3	5.51	33.15	0.09	24.85	0.24	129.67	1.0
2700	0.21	-153.3	5.33	30.04	0.09	24.72	0.28	120.55	1.2
2800	0.07	-127.7	6.44	28.98	0.12	24.46	0.28	80.88	1.2
2900	0.19	-167.20	4.88	19.14	0.10	20.48	0.27	105.15	1.2
3000	0.18	178.11	4.78	16.89	0.10	19.71	0.30	96.35	1.2
3100	0.18	165.13	4.57	16.56	0.11	18.98	0.32	89.48	1.0

9. Package outline

Plastic surface-mounted package; collector pad for good heat transfer; 3 leads

SOT89

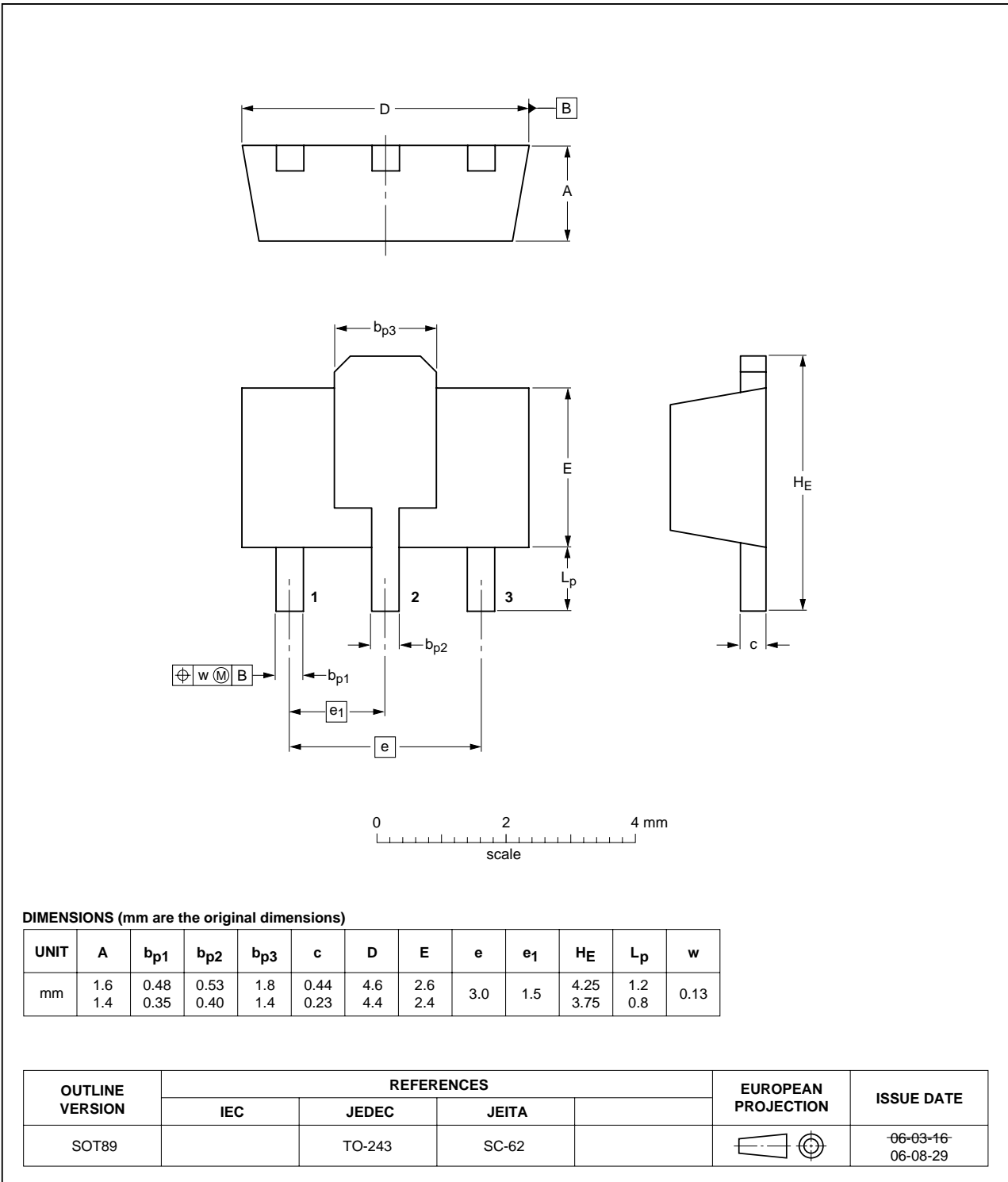

Fig 11. Package outline SOT89 (SC-62)

10. Abbreviations

Table 11. Abbreviations

Acronym	Description
CDPD	Cellular Digital Packet Data
IF	Intermediate Frequency
PCS	Power Center Substation
SMD	Surface-Mounted Device
SONET	Synchronous Optical NETWORK

11. Revision history

Table 12. Revision history

Document ID	Release date	Data sheet status	Change notice	Supersedes
BGA6589_2	20090525	Product data sheet	-	BGA6589_1
Modifications: <ul style="list-style-type: none"> • The format of this data sheet has been redesigned to comply with the new identity guidelines of NXP Semiconductors. • Legal texts have been adapted to the new company name where appropriate. • Changed I_S from 84 mA to 81 mA throughout. • Table 1: changed symbol V_S to V_D. • Table 5: changed symbol V_S to V_D and added "on pin 1;" to Conditions. • Table 7: added row for V_D DC device voltage. • Section 8: added sentence. • Figure 9: changed $V_S = 8\text{ V}$ to 9 V. • Table 9: added 51 Ω to all value columns for resistor R1 and amended values of C3 and C4. • Table 10: changed $V_S = 8\text{ V}$ to 9 V. 				
BGA6589_1	20030919	Product specification	-	-

12. Legal information

12.1 Data sheet status

Document status ^{[1][2]}	Product status ^[3]	Definition
Objective [short] data sheet	Development	This document contains data from the objective specification for product development.
Preliminary [short] data sheet	Qualification	This document contains data from the preliminary specification.
Product [short] data sheet	Production	This document contains the product specification.

[1] Please consult the most recently issued document before initiating or completing a design.

[2] The term 'short data sheet' is explained in section "Definitions".

[3] The product status of device(s) described in this document may have changed since this document was published and may differ in case of multiple devices. The latest product status information is available on the Internet at URL <http://www.nxp.com>.

12.2 Definitions

Draft — The document is a draft version only. The content is still under internal review and subject to formal approval, which may result in modifications or additions. NXP Semiconductors does not give any representations or warranties as to the accuracy or completeness of information included herein and shall have no liability for the consequences of use of such information.

Short data sheet — A short data sheet is an extract from a full data sheet with the same product type number(s) and title. A short data sheet is intended for quick reference only and should not be relied upon to contain detailed and full information. For detailed and full information see the relevant full data sheet, which is available on request via the local NXP Semiconductors sales office. In case of any inconsistency or conflict with the short data sheet, the full data sheet shall prevail.

12.3 Disclaimers

General — Information in this document is believed to be accurate and reliable. However, NXP Semiconductors does not give any representations or warranties, expressed or implied, as to the accuracy or completeness of such information and shall have no liability for the consequences of use of such information.

Right to make changes — NXP Semiconductors reserves the right to make changes to information published in this document, including without limitation specifications and product descriptions, at any time and without notice. This document supersedes and replaces all information supplied prior to the publication hereof.

Suitability for use — NXP Semiconductors products are not designed, authorized or warranted to be suitable for use in medical, military, aircraft, space or life support equipment, nor in applications where failure or malfunction of an NXP Semiconductors product can reasonably be expected to result in personal injury, death or severe property or environmental

damage. NXP Semiconductors accepts no liability for inclusion and/or use of NXP Semiconductors products in such equipment or applications and therefore such inclusion and/or use is at the customer's own risk.

Applications — Applications that are described herein for any of these products are for illustrative purposes only. NXP Semiconductors makes no representation or warranty that such applications will be suitable for the specified use without further testing or modification.

Limiting values — Stress above one or more limiting values (as defined in the Absolute Maximum Ratings System of IEC 60134) may cause permanent damage to the device. Limiting values are stress ratings only and operation of the device at these or any other conditions above those given in the Characteristics sections of this document is not implied. Exposure to limiting values for extended periods may affect device reliability.

Terms and conditions of sale — NXP Semiconductors products are sold subject to the general terms and conditions of commercial sale, as published at <http://www.nxp.com/profile/terms>, including those pertaining to warranty, intellectual property rights infringement and limitation of liability, unless explicitly otherwise agreed to in writing by NXP Semiconductors. In case of any inconsistency or conflict between information in this document and such terms and conditions, the latter will prevail.

No offer to sell or license — Nothing in this document may be interpreted or construed as an offer to sell products that is open for acceptance or the grant, conveyance or implication of any license under any copyrights, patents or other industrial or intellectual property rights.

Export control — This document as well as the item(s) described herein may be subject to export control regulations. Export might require a prior authorization from national authorities.

Quick reference data — The Quick reference data is an extract of the product data given in the Limiting values and Characteristics sections of this document, and as such is not complete, exhaustive or legally binding.

12.4 Trademarks

Notice: All referenced brands, product names, service names and trademarks are the property of their respective owners.

13. Contact information

For more information, please visit: <http://www.nxp.com>

For sales office addresses, please send an email to: salesaddresses@nxp.com

14. Contents

1 Product profile 1

1.1 General description 1

1.2 Features 1

1.3 Applications 1

1.4 Quick reference data 2

2 Pinning information 2

3 Ordering information 2

4 Marking 2

5 Limiting values 3

6 Thermal characteristics 3

7 Characteristics 3

8 Application information 7

9 Package outline 10

10 Abbreviations 11

11 Revision history 11

12 Legal information 12

12.1 Data sheet status 12

12.2 Definitions 12

12.3 Disclaimers 12

12.4 Trademarks 12

13 Contact information 12

14 Contents 13

Please be aware that important notices concerning this document and the product(s) described herein, have been included in section 'Legal information'.

