



FEATURES

- RoHS compliant
- Up to 2.8A I_{DC}
- 1.0μH to 2.2mH
- Low R_{DC}
- Small footprint
- Ultra-low profile
- UL 94V-0 packaging materials
- J-STD-020C reflow
- Custom inductance values available

PRODUCT OVERVIEW

The 8400 series is a range of miniature, surface-mount, I-core power inductors. They are designed for use in power applications with restricted PCB space and height, such as ExpressCard™ technology, handheld devices, DC-DC converters and notebook computers. The products are supplied in tape and reel for high-volume, automated surface-mount assembly.

SELECTION GUIDE

Order Code	Inductance, L	DC Current ²	DC Resistance
	±10% μH	Max. A	Max. Ω
84102C	1.0±20%	2.80	0.08
84132C	1.3±20%	2.50	0.08
84222C	2.2±20%	2.00	0.09
84332C	3.3±20%	1.50	0.12
84472C	4.7±20%	1.30	0.15
84682C	6.8±20%	1.05	0.20
84103C	10	0.95	0.24
84153C	15	0.75	0.45
84223C	22	0.60	0.60
84333C	33	0.55	0.86
84473C	47	0.42	1.1
84683C	68	0.38	1.6
84104C	100	0.30	2.0
84154C	150	0.25	3.2
84224C	220	0.20	4.6
84334C	330	0.17	6.5
84474C	470	0.14	8.5
84684C	680	0.12	11.5
84105C	1000	0.09	18.0
84155C	1500	0.08	27.0
84225C	2200	0.05	45

ABSOLUTE MAXIMUM RATINGS

Operating free air temperature range	-40°C to 125°C
Storage temperature range	-40°C to 150°C

SOLDERING INFORMATION¹

Peak reflow solder temperature	250°C
Pin finish	SAC 305
Moisture sensitivity level	1

PACKAGE SPECIFICATIONS

Mechanical Dimensions

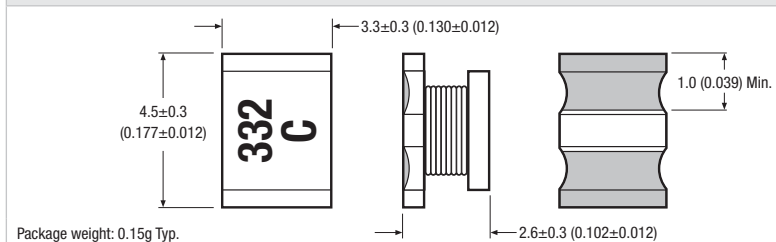

Recommended Footprint Details

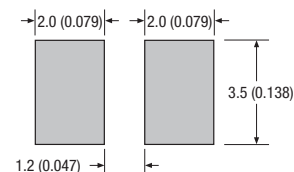

All dimensions in mm (inches)

Specifications typical at T_a = 25°C

1 For further information, please visit www.murata-ps.com/rohs

2 The maximum DC current is the value at which the inductance falls to 75% of its nominal value or when its temperature rise reaches 40°C, whichever is sooner.



INDUCTANCE Vs CURRENT

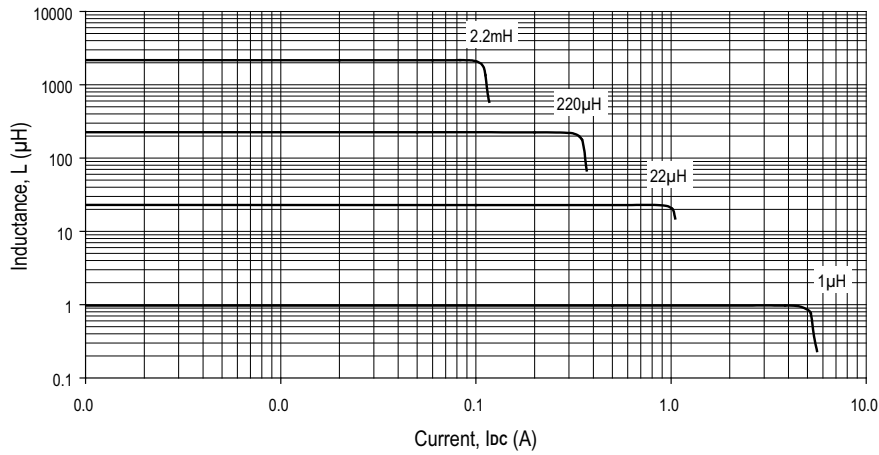

TEMPERATURE Vs CURRENT

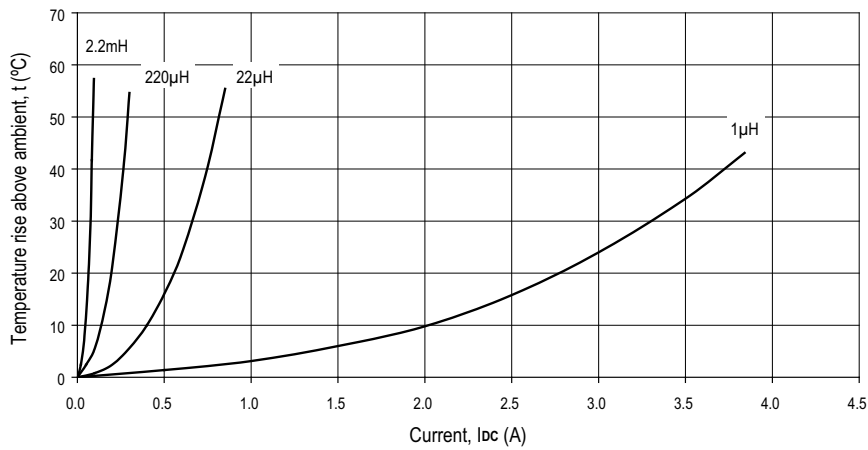

INDUCTANCE Vs FREQUENCY

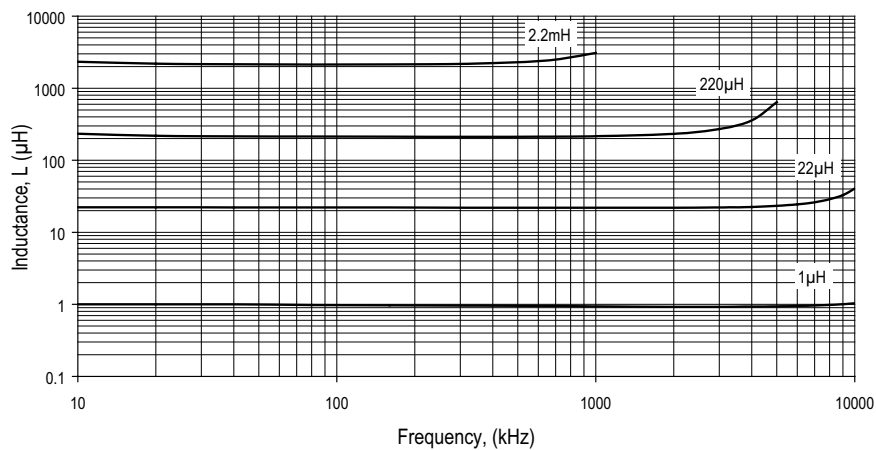

PACKAGE SPECIFICATIONS

Mechanical Dimensions

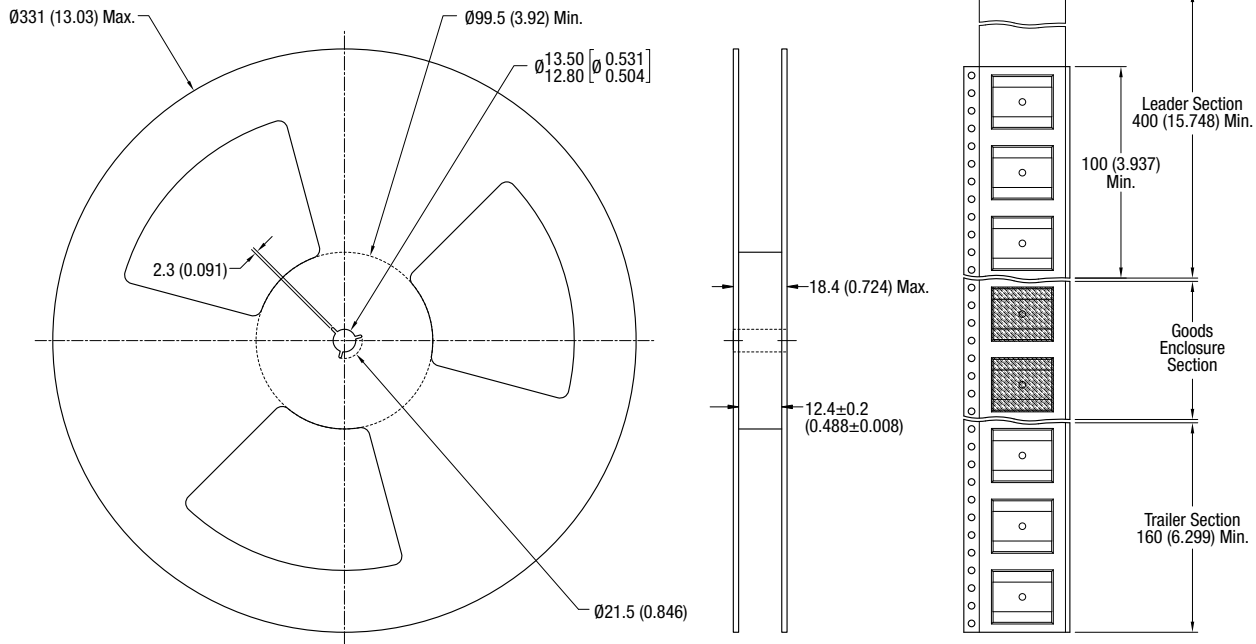

All dimension in mm [inches]

Tape Outline Dimensions

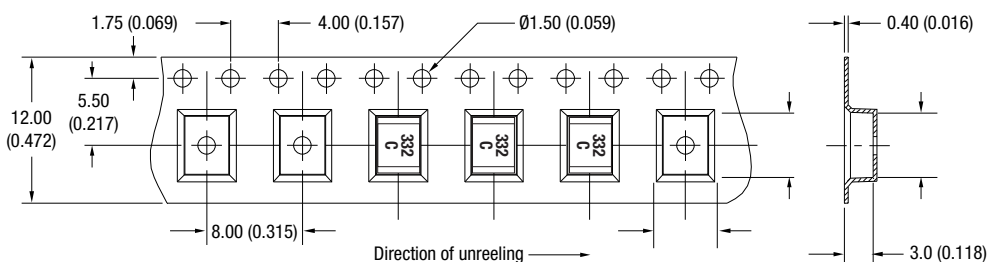

Reel quantity: 2000
Unless otherwise stated, all dimensions in mm (inches).

Murata Power Solutions, Inc.
11 Cabot Boulevard, Mansfield, MA 02048-1151 U.S.A.
Tel: (508) 339-3000 (800) 233-2765 Fax: (508) 339-6356
www.murata-ps.com email: sales@murata-ps.com ISO 9001 REGISTERED

Murata Power Solutions, Inc. makes no representation that the use of its products in the circuits described herein, or the use of other technical information contained herein, will not infringe upon existing or future patent rights. The descriptions contained herein do not imply the granting of licenses to make, use, or sell equipment constructed in accordance therewith. Specifications are subject to change without notice.
© 2008 Murata Power Solutions, Inc.

- USA:** Mansfield (MA), Tel: (800) 233 2765, email: sales@murata-ps.com
- Canada:** Toronto, Tel: (866) 740 1232, email: toronto@murata-ps.com
- UK:** Milton Keynes, Tel: +44 (0)1908 615232, email: mk@murata-ps.com
- France:** Montigny Le Bretonneux, Tel: +33 (0)1 34 60 01 01, email: france@murata-ps.com
- Germany:** München, Tel: +49 (0)89-544334-0, email: ped.munich@murata-ps.com
- Japan:** Tokyo, Tel: 3-3779-1031, email: sales_tokyo@murata-ps.com
Osaka, Tel: 6-6354-2025, email: sales_osaka@murata-ps.com
Website: www.murata-ps.jp
- China:** Shanghai, Tel: +86 215 027 3678, email: shanghai@murata-ps.com
Guangzhou, Tel: +86 208 221 8066, email: guangzhou@murata-ps.com