

Silicon NPN Power Transistors

2SC4559

DESCRIPTION

- With TO-220Fa package
- High speed switching
- High V_{CEO}

APPLICATIONS

- For high breakdown voltage ,high-speed switching applications

PINNING

PIN	DESCRIPTION
1	Base
2	Collector
3	Emitter

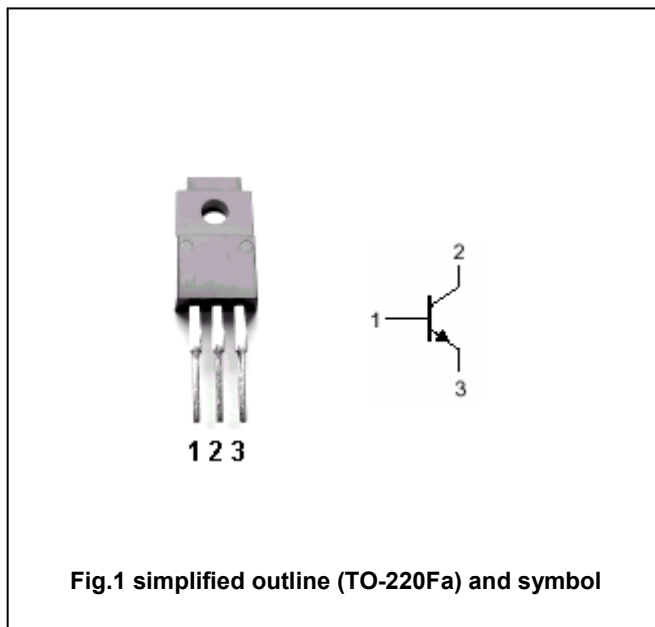

Absolute maximum ratings ($T_a=25^\circ\text{C}$)

SYMBOL	PARAMETER	CONDITIONS	VALUE	UNIT
V_{CBO}	Collector-base voltage	Open emitter	500	V
V_{CEO}	Collector-emitter voltage	Open base	400	V
V_{EBO}	Emitter-base voltage	Open collector	7	V
I_C	Collector current (DC)		7	A
I_{CM}	Collector current-Peak		15	A
I_B	Base current		3	A
P_C	Collector power dissipation	$T_C=25^\circ\text{C}$	40	W
		$T_a=25^\circ\text{C}$	2	
T_j	Junction temperature		150	$^\circ\text{C}$
T_{stg}	Storage temperature		-55~150	$^\circ\text{C}$

Silicon NPN Power Transistors

2SC4559

CHARACTERISTICS

T_j=25°C unless otherwise specified

SYMBOL	PARAMETER	CONDITIONS	MIN	TYP.	MAX	UNIT
V _{(BR)CEO}	Collector-emitter breakdown voltage	I _C =10mA, I _B =0	400			V
V _{CEsat}	Collector-emitter saturation voltage	I _C =3A; I _B =0.6A			1.0	V
V _{BEsat}	Base-emitter saturation voltage	I _C =3A; I _B =0.6A			1.5	V
I _{CBO}	Collector cut-off current	V _{CB} =500V; I _E =0			0.1	mA
I _{EBO}	Emitter cut-off current	V _{EB} =5V; I _C =0			0.1	mA
h _{FE-1}	DC current gain	I _C =0.1A; V _{CE} =5V	10			
h _{FE-2}	DC current gain	I _C =3A; V _{CE} =5V	8			
f _T	Transition frequency	I _C =0.5A; V _{CE} =10V; f=1MHz		5.5		MHz

Switching times

t _{on}	Turn-on time	I _C =3A; I _{B1} =0.6A I _{B2} =-1.2A; V _{CC} =150V			1.0	μs
t _s	Storage time				3.0	μs
t _f	Fall time				0.3	μs

Silicon NPN Power Transistors

2SC4559

PACKAGE OUTLINE

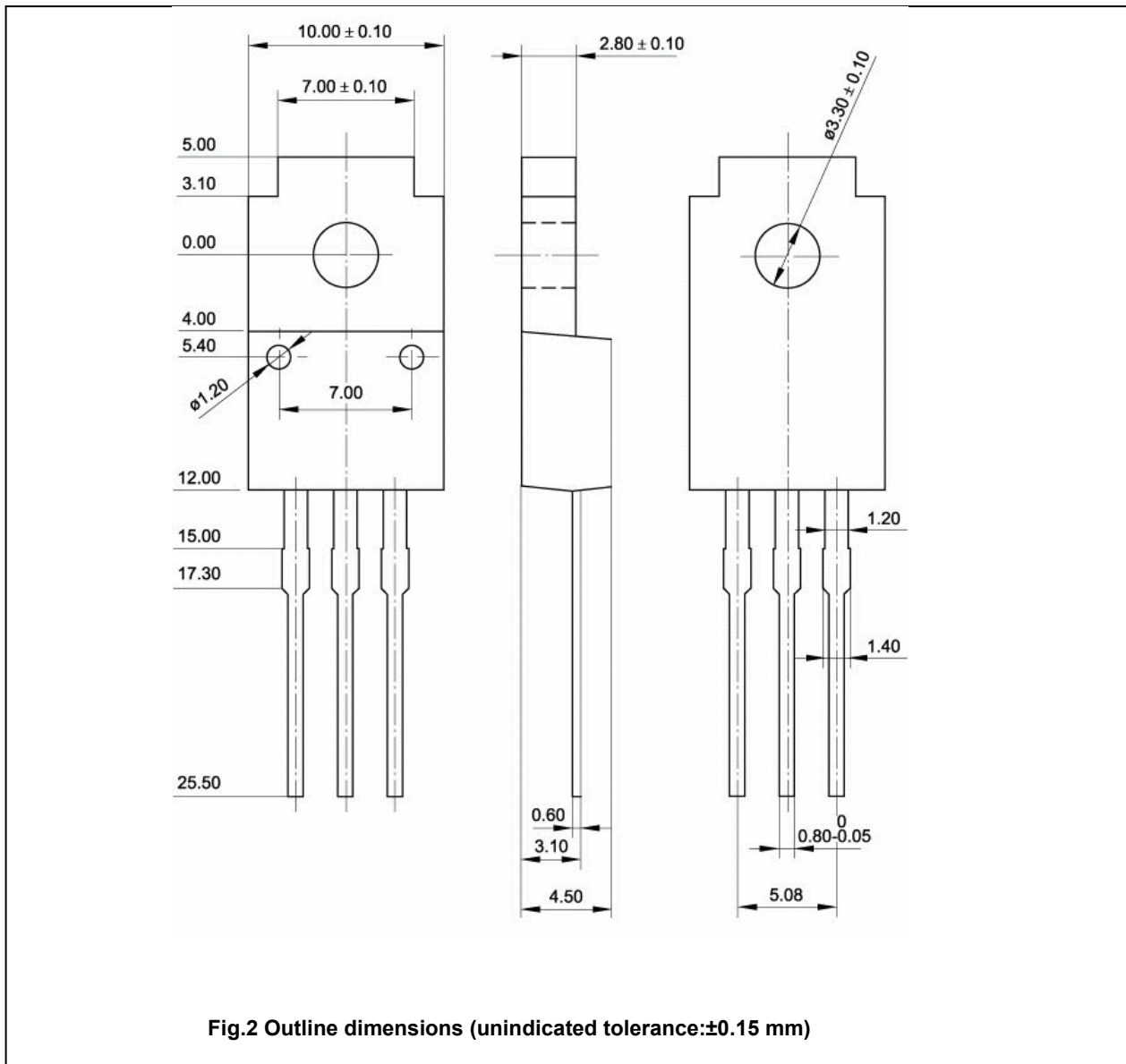

Silicon NPN Power Transistors

2SC4559

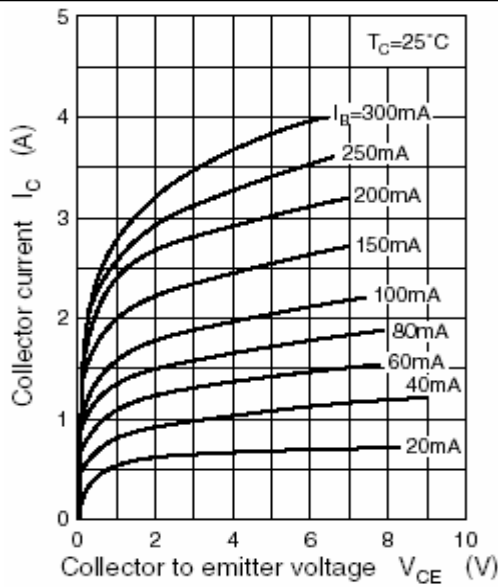

Fig.3 Static Characteristic

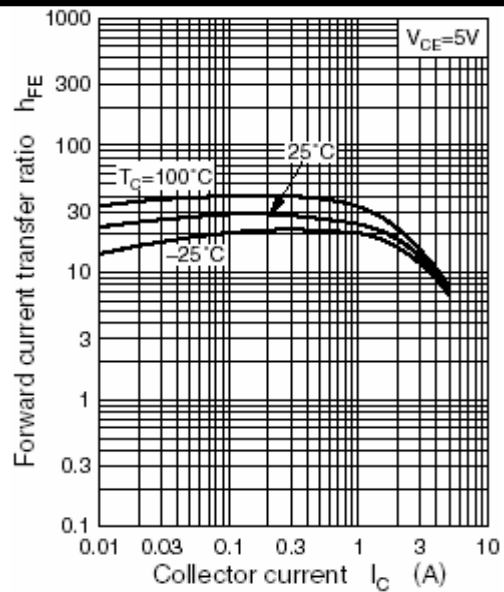

Fig.4 DC current Gain

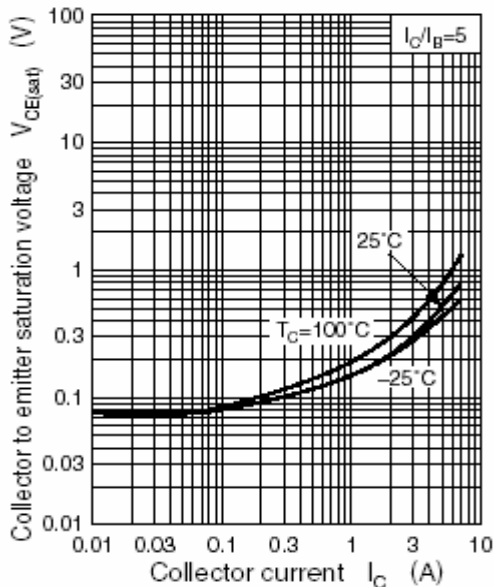

Fig.5 Collector-Emitter Saturation Voltage

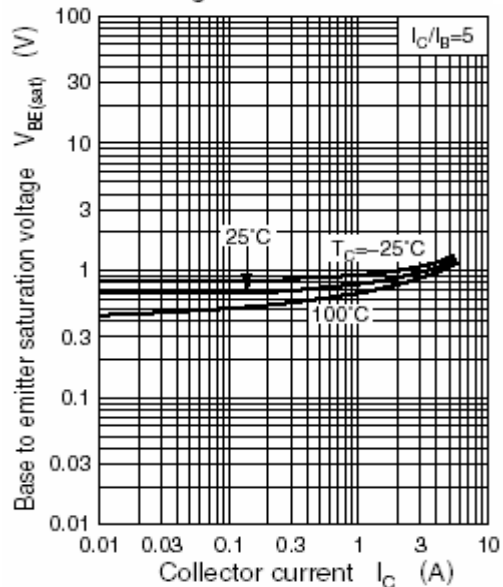

Fig.6 Base-Emitter Saturation Voltage

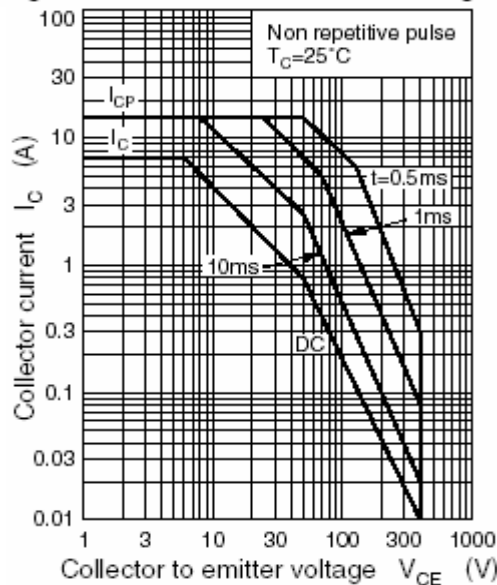

Fig.7 Safe Operating Area