



**CHENMKO ENTERPRISE CO.,LTD**

**CHT870PT**

**SURFACE MOUNT**

**N-Channel Enhancement Mode Field Effect Transistor**

VOLTAGE 60 Volts CURRENT 0.250 Ampere

*Lead free devices*

**APPLICATION**

- \* Servo motor control.
- \* Power MOSFET gate drivers.
- \* Other switching applications.

**FEATURE**

- \* Small surface mounting type. (SC-59)
- \* High density cell design for low R<sub>DS(ON)</sub>.
- \* Suitable for high packing density.
- \* Rugged and reliable.
- \* High saturation current capability.
- \* Voltage controlled small signal switch.

**CONSTRUCTION**

- \* N-Channel Enhancement

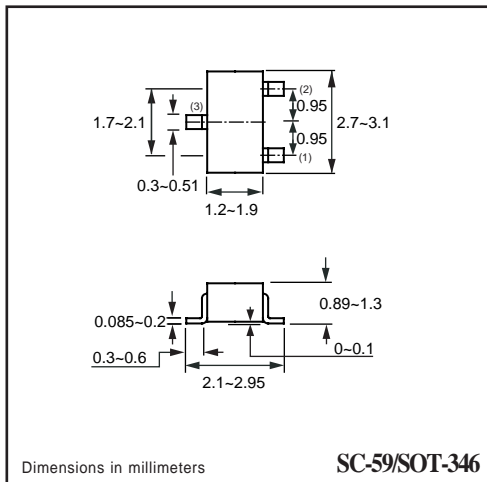

**CIRCUIT**

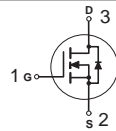

**Absolute Maximum Ratings** T<sub>A</sub> = 25°C unless otherwise noted

Symbol	Parameter	CHT870PT	Units
V <sub>DSS</sub>	Drain-Source Voltage	60	V
V <sub>DGR</sub>	Drain-Gate Voltage (R <sub>GS</sub> ≤ 1 MΩ)	60	V
V <sub>GSS</sub>	Gate-Source Voltage - Continuous - Non Repetitive (tp < 50μs)	±20	V
		±40	
I <sub>D</sub>	Maximum Drain Current - Continuous - Pulsed	T <sub>A</sub> = 25°C	mA
		T <sub>A</sub> = 70°C	
P <sub>D</sub>	Maximum Power Dissipation	T <sub>A</sub> = 25°C	mW
		T <sub>A</sub> = 70°C	210
T <sub>J</sub> , T <sub>STG</sub>	Operating and Storage Temperature Range	-55 to 150	°C
T <sub>L</sub>	Maximum Lead Temperature for Soldering Purposes, 1/16" from Case for 10 Seconds	300	°C

**Thermal characteristics**

R <sub>θJA</sub>	Thermal Resistance, Junction-to-Ambient	400	°C/W
------------------	---	-----	------

## RATING CHARACTERISTIC CURVES ( CHT870PT )

**Electrical Characteristics**  $T_A = 25^\circ\text{C}$  unless otherwise noted

Symbol	Parameter	Conditions	Min	Typ	Max	Units
--------	-----------	------------	-----	-----	-----	-------

### OFF CHARACTERISTICS

$BV_{DSS}$	Drain-Source Breakdown Voltage	$V_{GS} = 0\text{ V}, I_D = 100\mu\text{A}$	60	80		V
$I_{DSS}$	Zero Gate Voltage Drain Current	$V_{DS} = 60\text{ V}, V_{GS} = 0\text{ V}$			1	$\mu\text{A}$
		$T_C = 125^\circ\text{C}$			0.5	mA
$I_{GSSF}$	Gate - Body Leakage, Forward	$V_{GS} = 15\text{ V}, V_{DS} = 0\text{ V}$			10	nA
$I_{GSSR}$	Gate - Body Leakage, Reverse	$V_{GS} = -15\text{ V}, V_{DS} = 0\text{ V}$			-10	nA

### ON CHARACTERISTICS (Note 1)

$V_{GS(th)}$	Gate Threshold Voltage	$V_{DS} = V_{GS}, I_D = 250\mu\text{A}$	1	2.0	3.0	V
$R_{DS(on)}$	Static Drain-Source On-Resistance	$V_{GS} = 10\text{ V}, I_D = 250\text{ mA}$		2.0	5.0	$\Omega$
		$V_{GS} = 4.0\text{ V}, I_D = 100\text{ mA}$		2.5	4.0	
$V_{DS(on)}$	Drain-Source On-Voltage	$V_{GS} = 10\text{ V}, I_D = 500\text{ mA}$		0.6	3.75	V
		$V_{GS} = 5.0\text{ V}, I_D = 50\text{ mA}$		0.09	1.5	
$I_{D(on)}$	On-State Drain Current	$V_{GS} = 10\text{ V}, V_{DS} = 7.5V_{DS(on)}$	800	1800		mA
		$V_{GS} = 4.5\text{ V}, V_{DS} = 10V_{DS(on)}$	500	700		
$g_{FS}$	Forward Transconductance	$V_{DS} = 15 V_{DS(on)}, I_D = 200\text{ mA}$	100			mS

### DYNAMIC CHARACTERISTICS

$Q_g$	Total Gate Charge	$V_{DS} = 30\text{ V}, V_{GS} = 10\text{ V},$ $I_D = 250\text{ mA}$		0.6	1.0	nC
$Q_{gs}$	Gate-Source Charge			0.06	25	
$Q_{gd}$	Gate-Drain Charge			0.06	5	
$C_{iss}$	Input Capacitance	$V_{DS} = 25\text{ V}, V_{GS} = 0\text{ V},$ $f = 1.0\text{ MHz}$		25	50	pF
$C_{oss}$	Output Capacitance			6	25	
$C_{rss}$	Reverse Transfer Capacitance			1.2	5	
$t_{on}$	Turn-On Time	$V_{DD} = 30\text{ V}, R_L = 200\Omega,$ $I_D = 100\text{ mA}, V_{GS} = 10\text{ V},$ $R_{GEN} = 10\Omega$		7.5	20	nS
$t_r$				6		
$t_{off}$	Turn-Off Time	$V_{DD} = 30\text{ V}, R_L = 200\Omega,$ $I_D = 100\text{ mA}, V_{GS} = 10\text{ V},$ $R_{GEN} = 10\Omega$		7.5	20	nS
$t_f$				3		

Note:

1. Pulse Test: Pulse Width < 300 $\mu\text{s}$ , Duty Cycle < 2.0%.

# RATING CHARACTERISTIC CURVES ( CHT870PT )

## Typical Electrical Characteristics

Figure 1. On-Region Characteristics

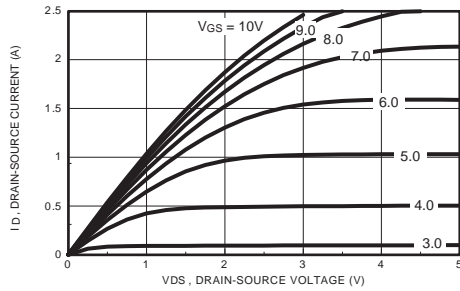

Figure 2. On-Resistance Variation with Gate Voltage and Drain Current

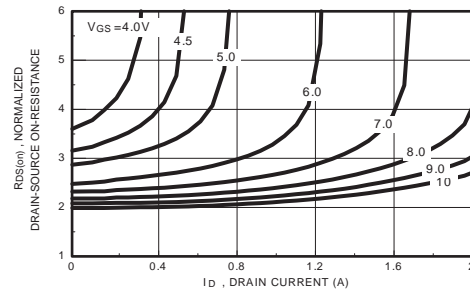

Figure 3. On-Resistance Variation with Temperature

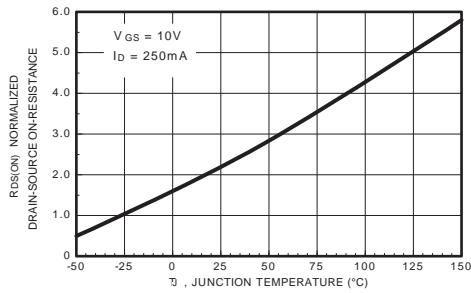

Figure 4. On-Resistance Variation with Drain Current and Temperature

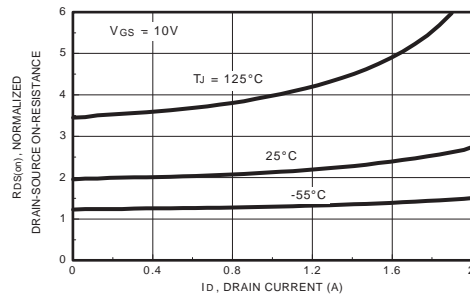

Figure 5. Transfer Characteristics

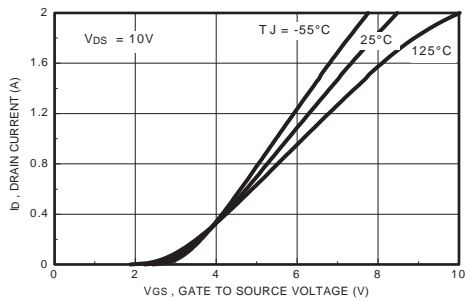
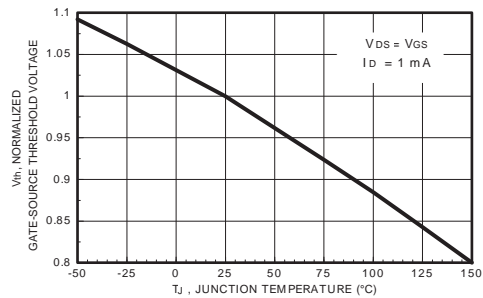

Figure 6. Gate Threshold Variation with Temperature



# RATING CHARACTERISTIC CURVES ( CHT870PT )

## Typical Electrical Characteristics (continued)

**Figure 7. Breakdown Voltage Variation with Temperature**

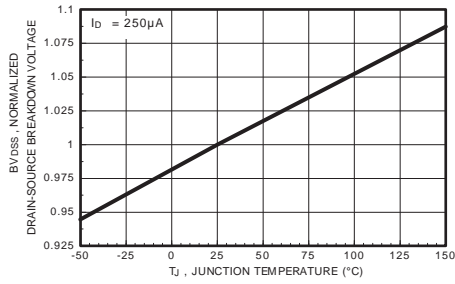

**Figure 8. Body Diode Forward Voltage Variation with Drain Current**

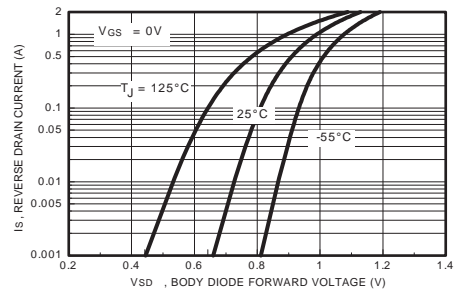

**Figure 9. Capacitance Characteristics**

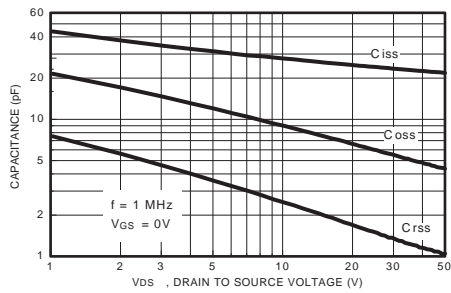

**Figure 10. Gate Charge Characteristics**

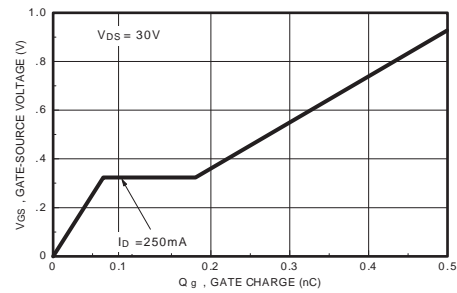

**Figure 11.**

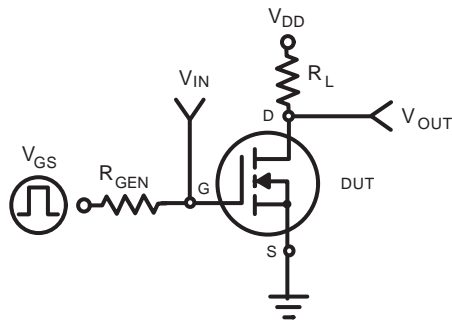

**Figure 12. Switching Waveforms**

