



CHENMKO ENTERPRISE CO.,LTD

CHT848BWPT

Lead free devices

SURFACE MOUNT
NPN General Purpose Transistor
 VOLTAGE 30 Volts CURRENT 0.1 Ampere

APPLICATION

- * AF input stages and driver applicationon equipment.
- * Other general purpose applications.

FEATURE

- * Surface mount package. (SC-70/SOT-323)
- * High current gain.
- * Suitable for high packing density.
- * Low collector-emitter saturation.
- * High saturation current capability.

MARKING

- * HFE(P):RN
- * HFE(Q):RO
- * HFE(Y):RP

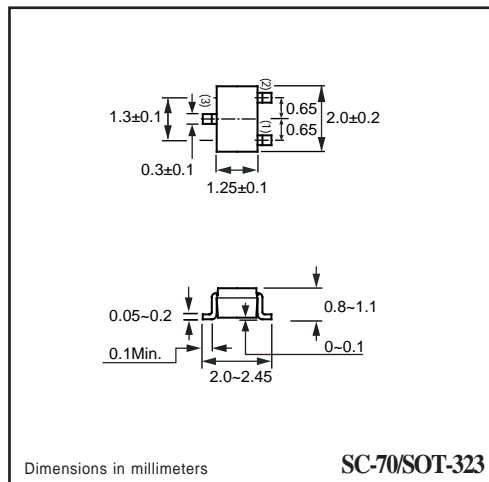
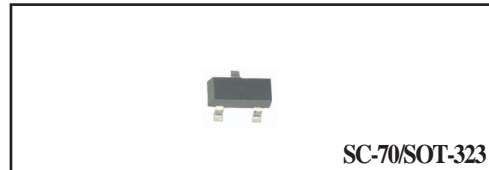

CIRCUIT

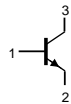

LIMITING VALUES

In accordance with the Absolute Maximum Rating System (IEC 60134).

SYMBOL	PARAMETER	CONDITIONS	MIN.	MAX.	UNIT
V _{CBO}	collector-base voltage	open emitter	—	30	V
V _{CEO}	collector-emitter voltage	open base	—	30	V
V _{EBO}	emitter-base voltage	open collector	—	5	V
I _C	collector current (DC)		—	0.1	A
P _C	Collector power dissipation		—	0.2	W
		Note2	—	0.3	
T _{stg}	storage temperature		-65	+150	°C
T _j	junction temperature		—	150	°C

Note

1. Transistor mounted on an FR4 printed-circuit board.
2. When mounted on a 7X5X0.6mm ceramic board.

RATING CHARACTERISTIC (CHT848BWPT)

THERMAL CHARACTERISTICS CHARACTERISTICS

$T_{amb} = 25\text{ }^{\circ}\text{C}$ unless otherwise specified.

SYMBOL	PARAMETER	CONDITIONS	MIN.	Typ.	MAX.	UNIT
I_{CBO}	collector cut-off current	$I_E = 0; V_{CB} = 30\text{ V}$	–	–	15	nA
h_{FE}	DC current transfer ratio	$V_{CE}/I_C = 5\text{V}/2\text{ mA}$	110	–	800	
V_{BEsat}	collector-base saturation voltage	$I_C = 10\text{ mA}; I_B = 0.5\text{ mA}$	–	700	–	mV
		$I_C = 100\text{ mA}; I_B = 5\text{ mA}$	–	900	–	mV
V_{CEsat}	collector-emitter saturation voltage	$I_C = 10\text{ mA}; I_B = 0.5\text{ mA}$	–	90	250	mV
		$I_C = 100\text{ mA}; I_B = 5\text{ mA}$	–	200	600	mV
$V_{BE(on)}$	base-emitter saturation voltage	$I_C = 2\text{ mA}; V_{CE} = 5.0\text{ V}$	0.58	0.66	0.70	V
		$I_C = 10\text{ mA}; V_{CE} = 5.0\text{ V}$	–	–	0.72	V
C_{ib}	emitter input capacitance	$I_C = 0; V_{CB} = 0.5\text{ V}; f = 1\text{ MHz}$	–	9	–	pF
C_{ob}	collector output capacitance	$I_E = 0; V_{CB} = 10\text{ V}; f = 1\text{ MHz}$	–	3.5	6	pF
f_T	transition frequency	$I_E = 10\text{ mA}; V_{CE} = 5\text{ V}; f = 100\text{ MHz}$	–	300	–	MHz
NF	noise figure	$V_{CE} = 5\text{ V}, I_C = 200\text{ }\mu\text{A}, F = 1\text{ KHz}, R_G = 2\text{ K}$	–	2	10	dB

Note

1. Pulse test: $t_p \leq 300\text{ }\mu\text{s}$; $\delta \leq 0.02$.
2. h_{FE} Classification P:110 to 220 Q: 200 to 450, Y: 420 to 800

RATING CHARACTERISTIC CURVES (CHT848BWPT)

fig1.Static Characteristic

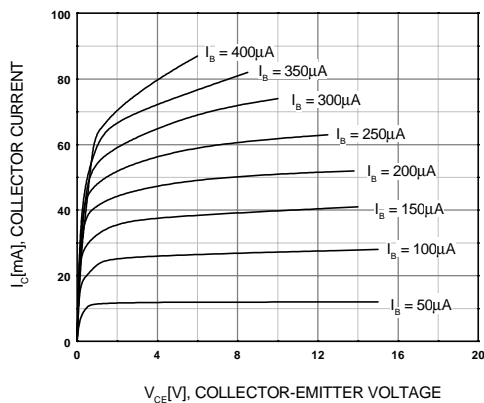
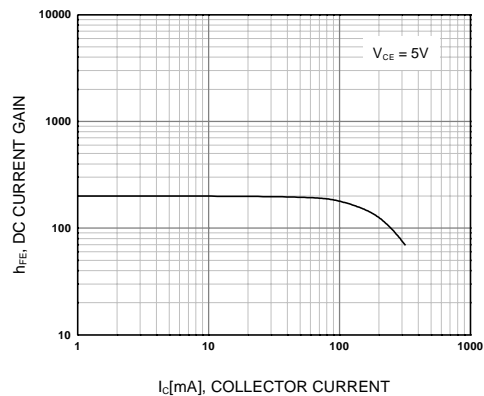

fig2.DC current Gain



RATING CHARACTERISTIC CURVES (CHT848BWPT)

fig3. Base-Emitter Saturation Voltage
Collector-Emitter Saturation Voltage

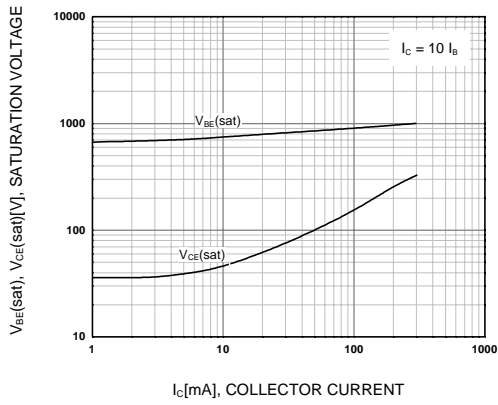

fig4. Base-Emitter On Voltage

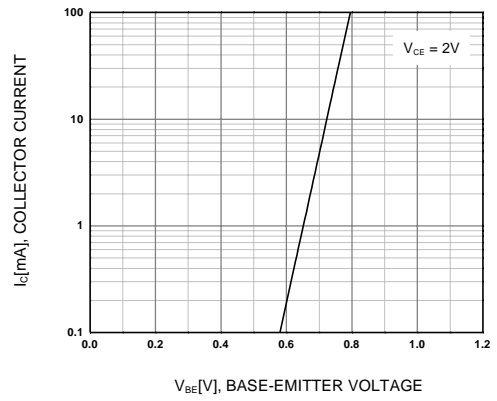

fig5. Collector Output Capacitance

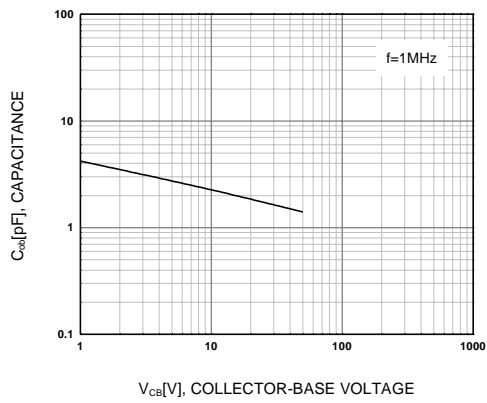

fig6. Current Gain Bandwidth Product

