



CHENMKO ENTERPRISE CO.,LTD

CHT2301WPT

SURFACE MOUNT

P-Channel Enhancement Mode Field Effect Transistor

VOLTAGE 20 Volts CURRENT 2.3 Ampere

Lead free devices

APPLICATION

- * Servo motor control.
- * Power MOSFET gate drivers.
- * Other switching applications.

FEATURE

- * Small surface mounting type. (SC-70/SOT-323)
- * High density cell design for low $R_{DS(ON)}$.
- * Suitable for high packing density.
- * Rugged and reliable.
- * High saturation current capability.
- * Voltage controlled small signal switch.

CONSTRUCTION

- * P-Channel Enhancement

MARKING

* 21

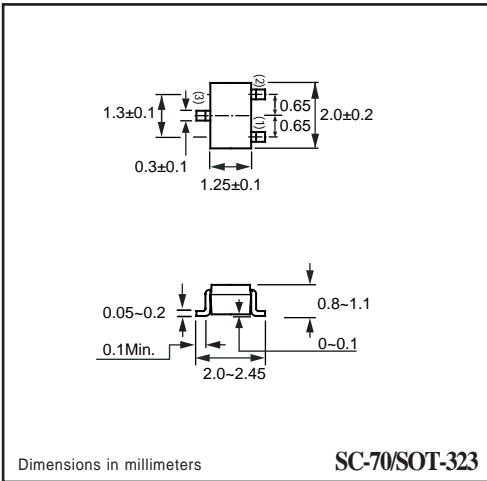

CIRCUIT

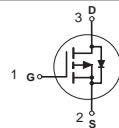

Absolute Maximum Ratings $T_A = 25^\circ\text{C}$ unless otherwise noted

Symbol	Parameter	CHT2301WPT	Units
V_{DSS}	Drain-Source Voltage	-20	V
V_{GSS}	Gate-Source Voltage	± 8	V
I_D	Maximum Drain Current - Continuous (Note 1)	-2.3	A
	- Pulsed (Note 2)	-10	
I_S	Drain-Source Diode Forward Current (Note 1)	-1.6	A
P_D	Maximum Power Dissipation (Note 1)	1250	mW
T_J, T_{STG}	Operating and Storage Temperature Range	-55 to 150	$^\circ\text{C}$

Note : 1. Surface Mounted on FR4 Board , $t \leq 10\text{sec}$
 2. Pulse Test , Pulse width $\leq 300\mu\text{s}$, Duty Cycle $\leq 2\%$

Thermal characteristics

$R_{\theta JA}$	Thermal Resistance, Junction-to-Ambient	85	$^\circ\text{C/W}$
-----------------	---	----	--------------------

RATING CHARACTERISTIC CURVES (CHT2301WPT)

Electrical Characteristics $T_A = 25^\circ\text{C}$ unless otherwise noted

Symbol	Parameter	Conditions	Min	Typ	Max	Units
--------	-----------	------------	-----	-----	-----	-------

OFF CHARACTERISTICS

BV_{DSS}	Drain-Source Breakdown Voltage	$V_{GS} = 0\text{ V}, I_D = -250\ \mu\text{A}$	-20			V
I_{DSS}	Zero Gate Voltage Drain Current	$V_{DS} = -16\text{ V}, V_{GS} = 0\text{ V}$			-1	μA
I_{GSS}	Gate-Body Leakage	$V_{GS} = 8\text{ V}, V_{DS} = 0\text{ V}$			+100	nA
I_{GSS}	Gate-Body Leakage	$V_{GS} = -8\text{ V}, V_{DS} = 0\text{ V}$			-100	nA

ON CHARACTERISTICS (Note 2)

$V_{GS(th)}$	Gate Threshold Voltage	$V_{DS} = V_{GS}, I_D = -250\ \mu\text{A}$	-0.6			V
$R_{DS(ON)}$	Static Drain-Source On-Resistance	$V_{GS} = -4.5\text{ V}, I_D = -2.8\text{ A}$			130	$\text{m}\Omega$
		$V_{GS} = -2.5\text{ V}, I_D = -2.0\text{ A}$			190	
V_{SD}	Diode Forward Voltage	$V_{DS} = 0\text{ V}, I_S = -1.0\text{ A}$			1.0	V

SWITCHING CHARACTERISTICS (Note 3)

Q_g	Total Gate Charge	$V_{DS} = -10\text{ V}, I_D = -1\text{ A}$ $V_{GS} = -4.5\text{ V}$		4.32		nC
Q_{gs}	Gate-Source Charge			1.06		
Q_{gd}	Gate-Drain Charge			0.84		
t_{on}	Turn-On Time	$V_{DD} = -10\text{ V}$ $I_D = -1.0\text{ A}, V_{GEN} = -4.5\text{ V}$ $R_L = 10\ \Omega, R_{GEN} = 10\ \Omega$		13		nS
t_r	Rise Time			36		
t_{off}	Turn-Off Time			42		
t_f	Fall Time			34		

Note : 3. Guaranteed by design , not subject to production trsting

RATING CHARACTERISTIC CURVES (CHT2301WPT)

Typical Electrical Characteristics

Figure 1. Output Characteristics

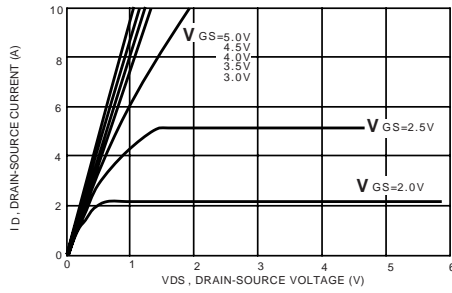

Figure 2. Transfer Characteristics

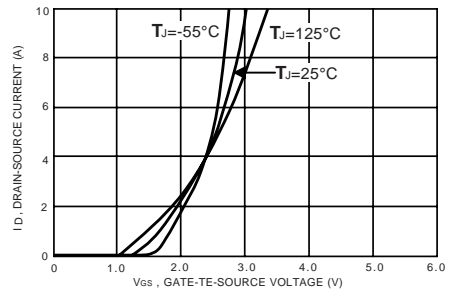

Figure 3. Breakdown Voltage Variation with Temperature

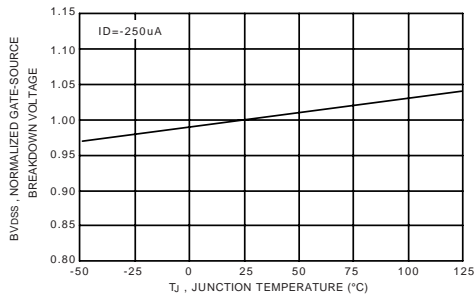

Figure 4. On-Resistance Variation with Temperature

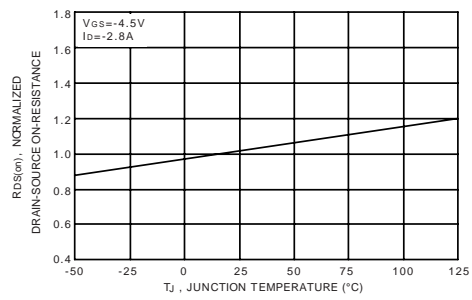

Figure 5. Gate Threshold Variation with Temperature

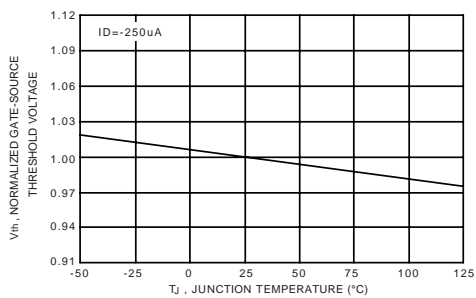

Figure 6. Gate Charge

