

# POWER RELAY

## 1 POLE 3A SLIM TYPE RELAY

### FTR-F3 Series

RoHS compliant

#### ■ FEATURES

- HIGH DENSITY MOUNTING  
Slim type with 7mm width and 142mm<sup>2</sup> mounting space
- HIGH ISOLATION  
Insulation Distance: Minimum 6mm between coil and contact (conforms to IEC 60065)  
Dielectric Strength: 4KV  
Surge Strength: 10KV
- HIGH COIL SENSITIVITY  
Nominal coil power consumption of 200mW
- CADMIUM FREE CONTACT FOR ECO-PROGRAM
- SAFETY STANDARDS  
UL, CSA, VDE, SEMKO, CQC
- Plastic sealed relay
- RoHS compliant since date code: 0435R1, 0432R2, 0429R3, 0434R4, 0437L2  
Please see page 6 for more information

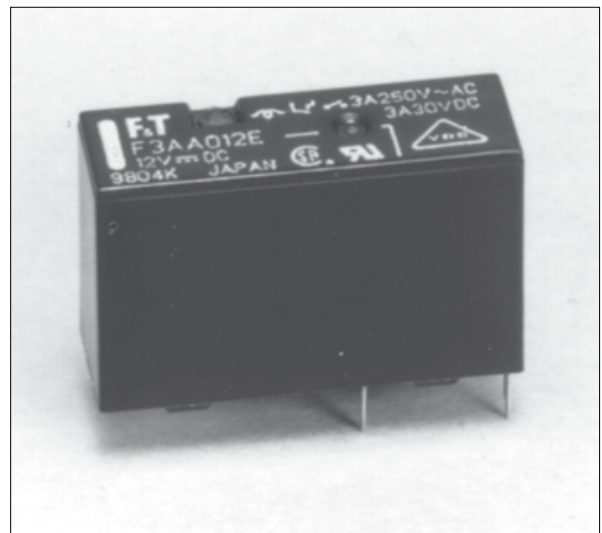

#### ■ ORDERING INFORMATION

[Example]      FTR-F3    A   A   012   E   -KS  
                   (a)    (b)(c) (d)   (e)   (f)

(a)	Series Name	FTR-F3
(b)	Contact Arrangement	A : 1 Form A (SPST-NO)
(c)	Coil Type	A : Standard (200mW)
(d)	Coil Nominal Voltage	005 : 5DC    012 : 12DC 006 : 6DC    018 : 18DC 009 : 9DC    024 : 24DC
(e)	Contact Material	E : Silver nickel
(f)	Contact Rating	Nil : 3A KS : 3A sealing confirmed

Remarks: Actual marking on relay would not carry code FTR and be as below:

Ordering code                      Actual marking  
 FTR-F3AA012E                    →                    F3AA012E

# FTR-F3 SERIES

## ■ PART NUMBERS

Ordering Part Number	Series	Contact	Coil Power	Coil Voltage	Contact Material	Contact Rating
FTR-F3AA005E	FTR-F3	1 form A	Standard (200 mW)	5	Silver nickel	3A
FTR-F3AA006E				6		
FTR-F3AA009E				9		
FTR-F3AA012E				12		
FTR-F3AA018E				18		
FTR-F3AA024E				24		
FTR-F3AA005E-KS				5		3A and sealed (guaranteed)
FTR-F3AA006E-KS				6		
FTR-F3AA009E-KS				9		
FTR-F3AA012E-KS				12		
FTR-F3AA018E-KS				18		
FTR-F3AA024E-KS				24		

## ■ COIL DATA CHART

Coil Voltage	Nominal Voltage (VDC)	Max. Coil Voltage*1	Coil Resistance ( $\pm 10\%$ )	Must Operate Voltage*2	Must Release Voltage*2	Coil Power
005	5	12.0 VDC	125 $\Omega$	3.75 VDC	0.5 VDC	200 mW
006	6	14.4 VDC	180 $\Omega$	4.5 VDC	0.6 VDC	
009	9	21.6 VDC	405 $\Omega$	6.75 VDC	0.9 VDC	
012	12	28.8 VDC	720 $\Omega$	9.0 VDC	1.2 VDC	
018	18	43.2 VDC	1,620 $\Omega$	13.5 VDC	1.8 VDC	
024	24	57.6 VDC	2,880 $\Omega$	18.0 VDC	2.2 VDC	

Note: All values in the table are measured at 20°C.

\*1: No contact current at 20°C

\*2: Specified values are subject to pulse wave voltage

# FTR-F3 SERIES

## ■ SPECIFICATIONS

Item		FTR-F3 AA ( ) E	
Contact	Arrangement	1 form A (SPST-NO)	
	Material	Silver nickel	
	Configuration	Single	
	Resistance (initial)	Maximum 100 mΩ at 6 VDC, 1 A	
	Rating	3 A, 125 VAC / 30 VDC	
	Maximum Carry Current	5A	
	Maximum Switching Power	750 VA / 90 W	
	Maximum Switching Voltage	277 VAC / 30VDC	
	Maximum Switching Load*1	10 mA 5 VDC	
Coil	Rating Power	200 mW	
	Must Operate Power	113 mW	
	Operating Temperature	-40°C to +70°C (no frost)	
Time Value	Operate Time (without diode)	Maximum 10 ms	
	Release Time (without diode)	Maximum 10 ms	
Life	Mechanical	5 x 10 <sup>6</sup> operations minimum	
	Electrical	200 x 10 <sup>3</sup> operations minimum	
Other	Vibration Resistance	Misoperation	10 to 55 Hz, at double amplitude of 1.5 mm
		Endurance	10-55Hz, at double amplitude of 1.5 mm
	Shock Resistance	Misoperation	Min. 100m/s <sup>2</sup> (11±1ms)
		Endurance	Min. 1,000m/s <sup>2</sup> (6±1ms)
	Weight	Approximately 4g	

\*1 Minimum switching loads mentioned above are reference values. Please perform the confirmation test with the actual load before production since reference values may vary according to switching frequencies, environmental conditions and expected reliability levels.

## ■ INSULATION

Item		FTR-F3
Resistance (500 VDC)		Minimum 1,000 MΩ
Dielectric Strength	open contacts	750 VAC (50/60 Hz) 1 min.
	coil and contacts	4,000 VAC (50/60 Hz) 1 min.
Surge Voltage (coil and contact)		10,000 V (1.2 x 50μs standard wave)
Clearance/Creepage		6 mm / 6 mm
Insulation (DIN EN61810-1 VDE0435)		
Voltage		250 V
Pollution		2
Isolation material group		Ila
Isolation category / Reference voltage (VDE01106)		C / 250 V

# FTR-F3 SERIES

## SAFETY STANDARDS

Type	Compliance	Contact rating
UL	UL 508 E63614	Flammability: UL 94-V0 (plastics) 3A, 30 VDC/ 277 VAC (resistive) 1/10 HP, 250VAC /125VAC
CSA	C22.2 No. 14 LR 40304	1/8 HP, 277VAC Pilot duty: D300
VDE	0435	3A, 250 VAC $\cos\phi=1$ , 200,000 ops. 85°C 3A, 30 VAC $\tau=0$ , 200,000 ops. 85°C 4A, 250 VAC break 1A $\cos\phi=0.8$ , 200,000 ops. 70°C
SEMKO	EN 61058-1: 1992 +A1:1993 EN 61095:1993+A11	5A, 250 VAC 40T70

## CHARACTERISTIC DATA

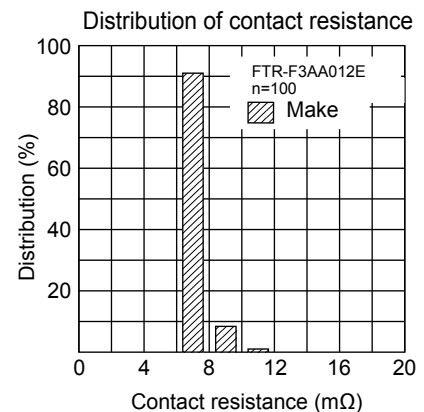
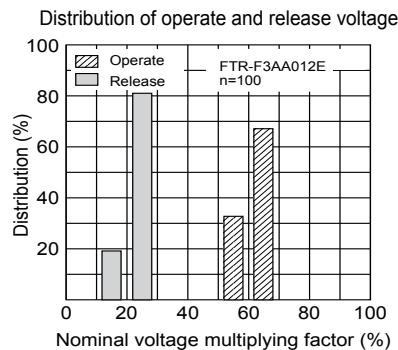
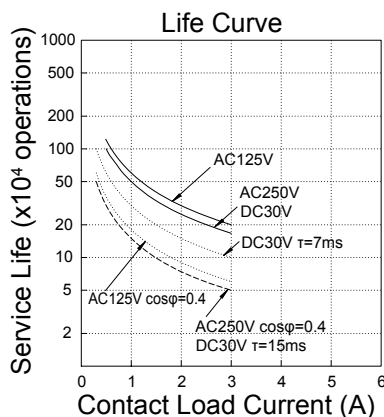
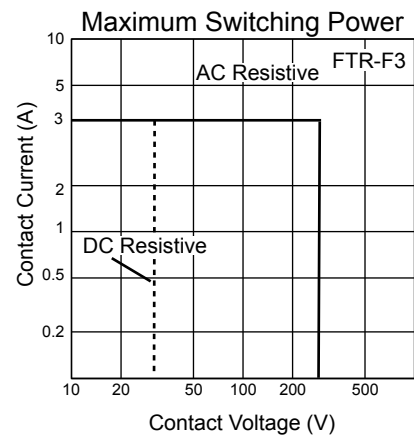
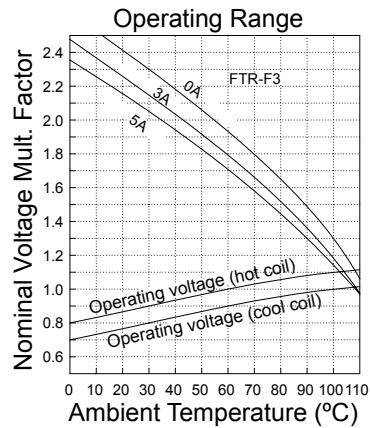
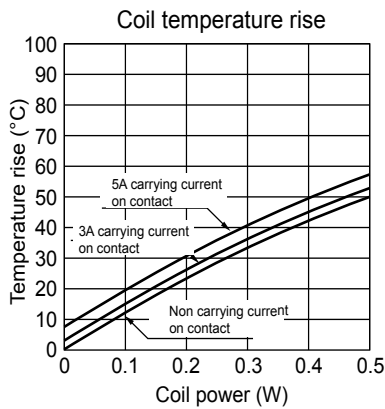

# FTR-F3 SERIES

## ■ DIMENSIONS

### ● Dimensions

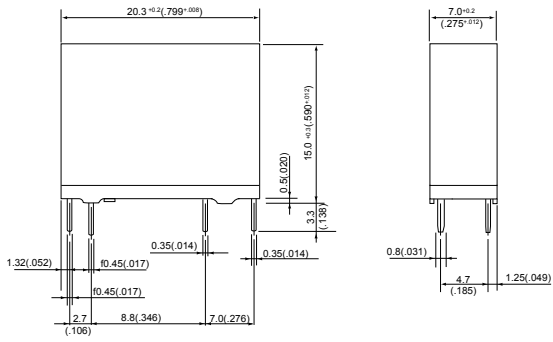

### ● Schematics (BOTTOM VIEW)

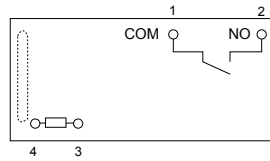

### ● PC board mounting hole layout (BOTTOM VIEW)

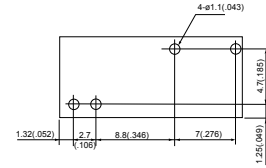

## RoHS Compliance and Lead Free Relay Information

### 1. General Information

- Relays produced after the specific date code that is indicated on each data sheet are lead-free now. All of our signal and power relays are lead-free. Please refer to Lead-Free Status Info. (<http://www.fujitsu.com/us/downloads/MICRO/fcai/relays/lead-free-letter.pdf>)
- Lead free solder paste currently used in relays is Sn-3.0Ag-0.5Cu.
- All signal and power relays also comply with RoHS. Please refer to individual data sheets. Relays that are RoHS compliant do not contain the 5 hazardous materials that are restricted by RoHS directive (lead, mercury, chromium IV, PBB, PBDE).
- It has been verified that using lead-free relays in leaded assembly process will not cause any problems (compatible).
- “LF” is marked on each outer and inner carton. (No marking on individual relays).
- To avoid leaded relays (for lead-free sample, etc.) please consult with area sales office.
- We will ship leaded relays as long as the leaded relay inventory exists.

Note: Cadmium was exempted from RoHS on October 21, 2005. (Amendment to Directive 2002/95/EC)

### 2. Recommended Lead Free Solder Profile

- Recommended solder paste Sn-3.0Ag-0.5Cu.

#### Reflow Solder condition

**Flow Solder condition:**

Pre-heating: maximum 120°C  
Soldering: dip within 5 sec. at  
260°C solder bath

**Solder by Soldering Iron:**

Soldering Iron  
Temperature: maximum 360°C  
Duration: maximum 3 sec.

**We highly recommend that you confirm your actual solder conditions**

### 3. Moisture Sensitivity

- Moisture Sensitivity Level standard is not applicable to electromechanical relays.

### 4. Tin Whisker

- Dipped SnAgCu solder is known as low risk tin whisker. No considerable length whisker was found by our in house test.

## Fujitsu Components International Headquarter Offices

### Japan

Fujitsu Component Limited  
Gotanda-Chuo Building  
3-5, Higashigotanda 2-chome, Shinagawa-ku  
Tokyo 141, Japan  
Tel: (81-3) 5449-7010  
Fax: (81-3) 5449-2626  
Email: [promothq@ft.ed.fujitsu.com](mailto:promothq@ft.ed.fujitsu.com)  
Web: [www.fcl.fujitsu.com](http://www.fcl.fujitsu.com)

### North and South America

Fujitsu Components America, Inc.  
250 E. Caribbean Drive  
Sunnyvale, CA 94089 U.S.A.  
Tel: (1-408) 745-4900  
Fax: (1-408) 745-4970  
Email: [components@us.fujitsu.com](mailto:components@us.fujitsu.com)  
Web: <http://www.fujitsu.com/us/services/edevices/components/>

### Europe

Fujitsu Components Europe B.V.  
Diamantlaan 25  
2132 WV Hoofddorp  
Netherlands  
Tel: (31-23) 5560910  
Fax: (31-23) 5560950  
Email: [info@fceu.fujitsu.com](mailto:info@fceu.fujitsu.com)  
Web: [emea.fujitsu.com/components/](http://emea.fujitsu.com/components/)

### Asia Pacific

Fujitsu Components Asia Ltd.  
102E Pasir Panjang Road  
#01-01 Citilink Warehouse Complex  
Singapore 118529  
Tel: (65) 6375-8560  
Fax: (65) 6273-3021  
Email: [fcal@fcal.fujitsu.com](mailto:fcal@fcal.fujitsu.com)  
Web: <http://www.fujitsu.com/sg/services/micro/components/>

©2007 Fujitsu Components America, Inc. All rights reserved. All trademarks or registered trademarks are the property of their respective owners.

Fujitsu Components America or its affiliates do not warrant that the content of datasheet is error free. In a continuing effort to improve our products Fujitsu Components America, Inc. or its affiliates reserve the right to change specifications/datasheets without prior notice.  
Rev. September 29, 2007