

# Encoder Hollow Shaft Type

SRGA Series



Hollow shaft vertical encoders deliver increased ease of use.

Detector

Push

Slide

Rotary

**Encoders**

Power

Dual-in-line  
Package Type

TACT Switch™

Custom-  
Products

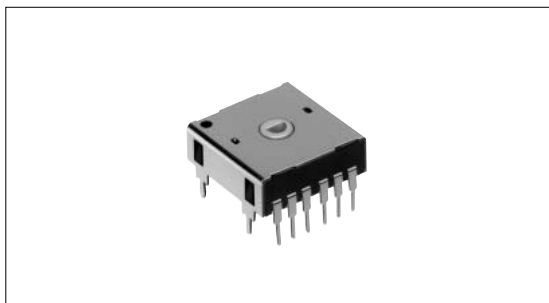

## Typical Specifications

Items		Specifications
Rating(max.)(min.) (Resistive load)		0.1A 12V DC/50μA 3V DC
Contact resistance (Initial/After operating life)		1 max./1 max.
Operating life	Without load	10,000cycles
	With load	10,000cycles( 0.1A 12V DC )

## Product Line

Torque (mN·m)	Operating direction	Output code	Positions	Changeover angle	Type	Minimum order unit ( pcs. )	Product No.	Drawing No.
20 ± 10	Vertical	Gray	8	45°	Standard ( hollow shaft )	1,680	SRGAV80601	1
			12	30°			SRGAVC0301	
			24	15°			SRGAVQ1100	
Without detent	13	Reflow	900		SRGAR10100	2		

## Taping Specification (Taping Packaging)

Reel Size Unit:mm

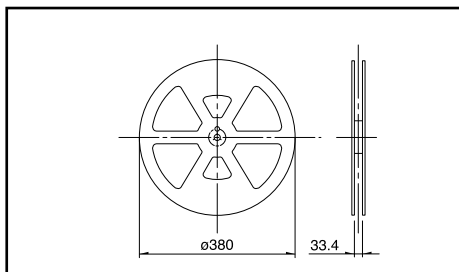

Series	Number of packages( pcs. )			Tape width ( mm )
	1 reel	1 case /Japan	1 case /export packing	
SRGAR10100	300	300	600	32

## Notes

1. Products other than those listed in the above chart are also available. Please contact us for details.
2. Please contact us for automotive use products.
3. Please place purchase orders per minimum order unit (integer).

Incremental  
Type

**Absolute  
Type**

Dimensions

Unit:mm

No.	Style	PC board mounting hole dimensions (Viewed from the Direction A)
1		
2		

- Detector
- Push
- Slide
- Rotary
- Encoders**
- Power
- Dual-in-line Package Type
- TACT Switch™
- Custom-Products

- Incremental Type
- Absolute Type**

Detail of (a)

Unit:mm

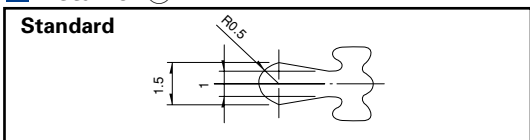

Note

④⑤ of SRGAV80601 and ⑤ of SRGAVC0301 are dummy terminals.

Standard Code (Viewed from Direction A)

SRGA





Code	Terminal	Number of positions	24																							
			Position	8								12														
			1	2	3	4	5	6	7	8	9	10	11	12	13	14	15	16	17	18	19	20	21	22	23	24
Gray	1																									
	2																									
	3																									
	4																									
	5																									

SRGAR

Code	Terminal	Number of positions	24																							
			Position	13																						
			1	2	3	4	5	6	7	8	9	10	11	12	13	14	15	16	17	18	19	20	21	22	23	24
Gray	1																									
	2																									
	3																									
	4																									

The marks show the ON position.  
For terminal alignment, please refer to the illustration.  
Please note that there might be ON output of the dummy terminal in the circuit design.

## List of Varieties

Type		Absolute type				
		With Knob	Metal shaft	Hollow shaft	Jog-shuttle	
Series		SRRQ	SRGH	SRGA	SRGPHJ	
Photo						
Output		Absolute type				
Outline specifications	Shaft types	With knob	Single-shaft	Hollow shaft	Single-shaft/ Dual-shaft	
	Operating direction	Vertical/Horizontal	Vertical			
	Number of pulse/ Number of detent	—————				
	Push switch (Travel mm)	Without				
	Optional functions	—————				
Dimensions (mm)	Changeover angle	22.5°, 36°	40°, 12.8°	15°, 24°, 30°, 45°	Shuttle part: All angles rotation 160° Jog part: All angles rotation 360°	
	W	14.4	20	18	35	
	D	15.6	19		43.7	
H	7.5	10.5	8	8.6		
Soldering	Manual soldering	300 ± 10 , 3 <sup>+1</sup> s		350 ± 10 , 3 <sup>+1</sup> s		
	Dip soldering	260 ± 5 , 10 ± 1s			260 ± 5 , 5 ± 1s	
	Reflow soldering	—————			Please see P.209	
Operating temperature range		-10 to +60	-40 to +85	-10 to +60		
Electrical performance	Initial contact resistance		1 max.			
	Output voltage	Shuttle part	—————			
		Jog part	4V min. at 1mA 5V DC (resistive load)			
Insulation resistance		100M min. 100V DC				
Mechanical performance	Voltage proof		100V AC for 1minute			
	Rotational torque		Shall be in accordance with individual specifications.			
	Terminal strength		5N for 1minute			
	Resistance to soldering heat	Rotational direction	—————			
		Push direction	5N	100N		
Vibration		10 to 55 to 10Hz/min., the amplitude is 1.5mm for all the frequencies, in the 3 direction of X, Y and Z for 2 hours respectively				
Environmental performance	Cold		-20 ± 2 for 96h			
	Dry heat		85 ± 2 for 96h			
	Damp heat		40 ± 2 , 90 to 95%RH for 96h			
Page		202	204	206	208	

Detector  
Push  
Slide  
Rotary  
Encoders  
Power  
Dual-in-line Package Type  
TACT Switch™  
Custom-Products

Incremental Type  
Absolute Type

**Note**  
The operating temperature range for automotive applications can be raised upon request. Please contact us for requirements of this kind.

# Soldering Conditions

## Example of Reflow Soldering Condition

1. Heating method: Double heating method with infrared heater.
2. Temperature measurement: Thermocouple 0.1 to 0.2 CA (K) or CC (T) at soldering portion (copper foil surface). A heat resisting tape should be used for fixed measurement.
3. Temperature profile

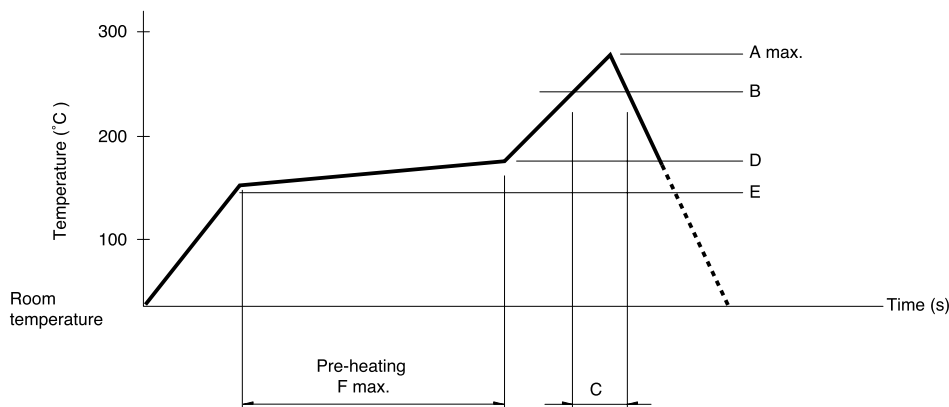

Series (Reflow type)	A (°C) max.	B (°C)	C (s)	D (°C)	E (°C)	R (s)
SRGP30	240	230	20	150	150	120
SRGP30	260		40	180		
SRGAR10100	240	220	30	160		

### Notes

1. The condition mentioned above is the temperature on the mounting surface of a PC board. There are cases where the PC board's temperature greatly differs from that of the switch, depending on the PC board's material, size, thickness, etc. The above-stated conditions shall also apply to switch surface temperatures.
2. Soldering conditions differ depending on reflow soldering machines. Prior verification of soldering condition is highly recommended.

# Attached Parts

The following parts are included with the product.

## SRGH Series

Unit:mm

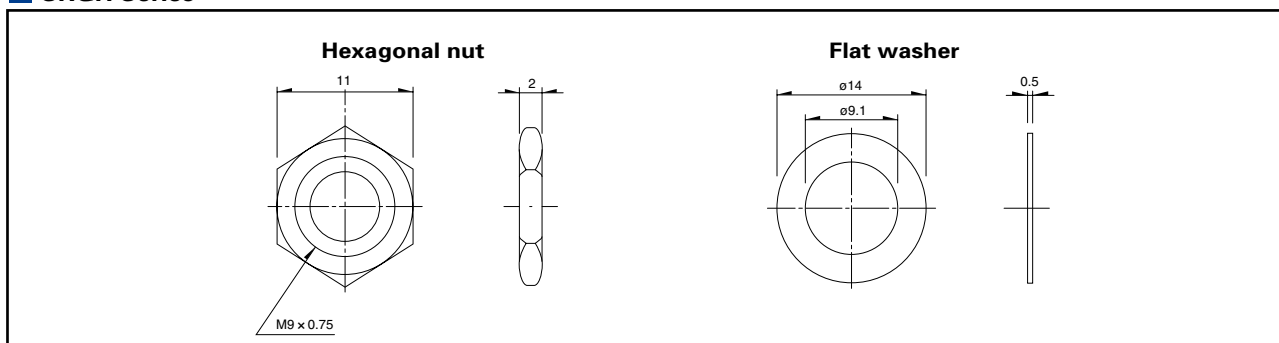

- Detector
- Push
- Slide
- Rotary
- Encoders**
- Power
- Dual-in-line Package Type
- TACT Switch™
- Custom-Products

- Incremental Type
- Absolute Type**