

Rotary Switch 12-position General-purpose Vertical Type

SRRM Series



General-purpose type switch applicable to a wide range of electronic devices.



Typical Specifications

Items		Specifications
Rating (max.) (min.) (Resistive load)		0.25A 30V DC/50μA 3V DC
Contact resistance (Initial/After operating life)		20m max./60m max.
Rotational torque	Shorting	80 ± 30mN·m
	Non-shorting	70 ± 30mN·m
Operating life	Without load	10,000cycles
	With load	10,000cycles(0.25A 30V DC)

Product Line

Poles	Positions	Changeover angle	Changeover timing	Actuator configuration	Actuator length (mm)	Minimum order unit(pcs.)	Product No.
1	12 Endless	30 ± 3 °	Shorting	Round shaft with groove	15	600	SRRM1C6200
			Non shorting	Flat	20		SRRM1C5400
Shorting	Round shaft with groove			15	SRRM1C7800		
	2		5	Shorting	Flat		20
6			SRRM262400				
3	4		Round shaft with groove	20	SRRM264300		
4	3	18-tooth serration	SRRM342800				
						SRRM433700	

Dimensions

Unit:mm

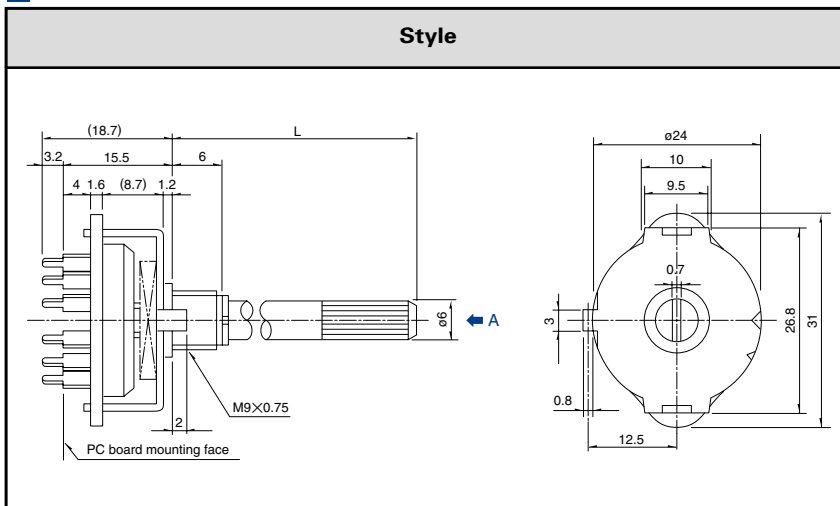

Terminal Configuration

Unit:mm

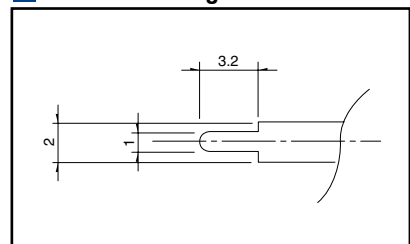

Notes

1. Products other than those listed in the above chart are also available. Please contact us for details.
2. Non-shorting type requires external wiring of common terminals.
3. All the axis are die casting shafts.
4. Please place purchase orders per minimum order unit(integer).
5. Round-shaft with groove (shaft length 20mm) type are 8mm length.

Refer to P.171 for shaft configurations.
Refer to P.173 for attached parts.

Standard Circuit Diagram
Shorting Circuit Diagram

Unit:mm

	1-pole, 12-positions	2-poles, 5-positions	2-poles, 6-positions	3-poles, 4-positions	4-poles, 3-positions
Circuit diagram					
PC board mounting hole dimensions (Viewed from the direction A)					

Non Shorting Circuit Diagram









Unit:mm

	1-pole, 12-positions	2-poles, 6-positions
Circuit diagram		
PC board mounting hole dimensions (Viewed from the direction A)		

Notes

1. The mark in the above table indicate a stopper with the shaft turned fully counterclockwise when viewed from direction A of the diagrams.
2. Note that the location of C terminal differs depending on the number of positions.
3. External wiring is required if specified in the above diagrams.

List of Varieties

Series		SRBD	SRBQ		SRRM	SRBV	SRBM		SRRN						
			Insertion	Reflow type			Rotary	Pulse							
Photo															
Outline specifications	Step angle	36 °	40 ± 3 °		30 ± 3 °			18 ± 3 °	30 ± 3 °						
	Number of poles	1		1 2 3 4	1	1 2	2 3 4								
Dimensions (mm)		W	11.4		16.2		12.5		—						
		D	12.4		18.5		10								
		H	3.5		7.5		11.5								
Operating temperature range		-25 to +85		-10 to +60		-40 to +85		-10 to +60							
Rating(max)/(min) (Resistive load)		1mA 5V DC 50μA 3V DC		0.1A 16V DC 50μA 3V DC		0.25A 30V DC 50μA 3V DC		0.3A 16V DC 50μA 3V DC		0.1A 16V DC 50μA 3V DC		0.15A 12V DC 50μA 3V DC			
Electrical performance	Initial contact resistance	100M min. 100V DC			100M min. 500V DC		100M min. 100V DC			100M min. 500V DC					
	Insulation resistance	100V AC for 1minute			500V AC for 1minute		100V AC for 1minute			500V AC for 1minute					
	Voltage proof	3N for 1minute		5N for 1minute		10N for 1minute		5N for 1minute							
Mechanical performance	Actuator strength	Rotational direction	—		1N·m		0.6N·m		0.5N·m		1N·m				
		Push direction	50N		20N		100N								
	Wobble of actuator	Load at the tip of shaft SRRM : 5N SRBV, SRBQ : 1N		The below table shows for SRBQ (Unit : mm)			The below table shows for SRBV (Unit : mm)			Measuring position from mounting surface	Shaft wobble (max. value)	Applicable mounting dimension			
		(Unit : mm)		Distance from mounting surface to the tip of shaft		Shaft wobble (max. value)		(Unit : mm)		Measuring position from mounting surface		Shaft wobble (max. value)		Applicable mounting dimension	
		10 0.17 15		below 5		0.5 max.		10 0.2 15		10mm		0.17 mm		15 mm	
		15 0.25 20		above 5 and below 10		0.9 max.		15 0.3 20		15mm		0.25 mm		20 mm	
				above 10 and below 15		1.2 max.				Load at the tip of shaft : 5N					
Durability	Operating life without load	10,000cycles 250m max.		10,000cycles 100m max.		10,000cycles 40m max.		10,000cycles 100m max.		30,000cycles 100m max.		10,000cycles 70m max.			
	Operating life with load Load : (at rated load)	10,000cycles 250m max.		10,000cycles 100m max.		10,000cycles 60m max.		10,000cycles 150m max.		10,000cycles 100m max.					
Environmental performance	Cold	-40 ± 2 for 500h		-20 ± 2 for 96h											
	Dry heat	85 ± 2 for 500h		85 ± 2 for 96h											
	Damp heat	60 ± 2 , 90 to 95%RH for 500h		40 ± 2 , 90 to 95%RH for 96h											
Soldering	Manual soldering	—		350 ± 10 3 ⁺ 1s		350 ± 5 3s max.		350 ± 10 , 3 ⁺ 1s							
	Dip soldering	—		260 ± 5 5 ± 1s		—		260 ± 5 10 ± 1s		260 ± 3 5s max.		260 ± 5 10 ± 1s			
	Reflow soldering	Please see P.172													
Page		158		160		167		165		162		169			

Detector
Push
Slide
Rotary
Encoders
Power
Dual-in-line Package Type
TACT Switch™
Custom-Products

Rotary Switches Shaft Style171
 Rotary Switches Soldering Conditions172
 Rotary Switches Attached Parts173
 Rotary Switches Cautions174

Shaft Configurations

18-tooth Serration Shaft

The shaft shows the position in which it is turned fully counterclockwise.

Cutting Shaft

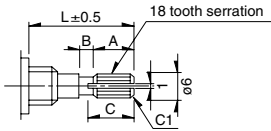

Die Casting Shaft

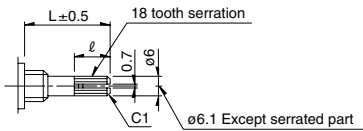

Unit:mm

Shaft length L	A	B	C
15	6	1	7
20	10	2	11

Unit:mm

Shaft length L	ℓ
15	8
20	12

Details About Serration

- (1) The mold dimensions of standard serration and the dimensions of test jigs are as shown in the figure at left.
- (2) Position of the serration bottom
When the shaft is turned fully counterclockwise, the position of the serration bottom is on the AA line.
- (3) Slitting angle
The slitting angle (position) is not specified.

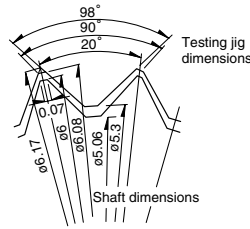

Round Shaft

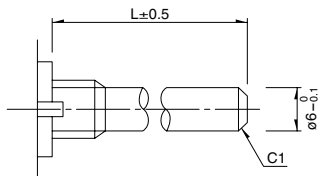

Round Shaft with Groove

The shaft shows the position in which it is turned fully counterclockwise.

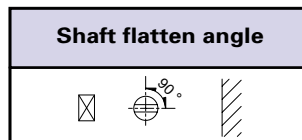
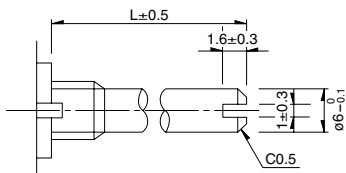

Flat Shaft

The shaft shows the position in which it is turned fully counterclockwise.

Cutting Shaft

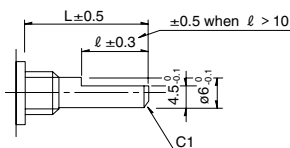

Die Casting Shaft

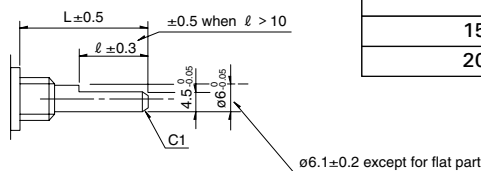

Unit:mm

Shaft length L	ℓ
15	7
20	12

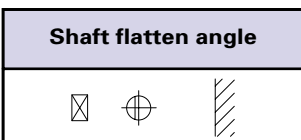

Note

SRBM Series are based on (printed terminal direction). SRRM, SRRN, SRBV Series are based on (panel lug).

Detector

Push

Slide

Rotary

Encoders

Power

Dual-in-line
Package Type

TACT Switch™

Custom-
Products

Attached Parts

The following parts are included with the product.

■ SRRM, SRBV

Unit:mm

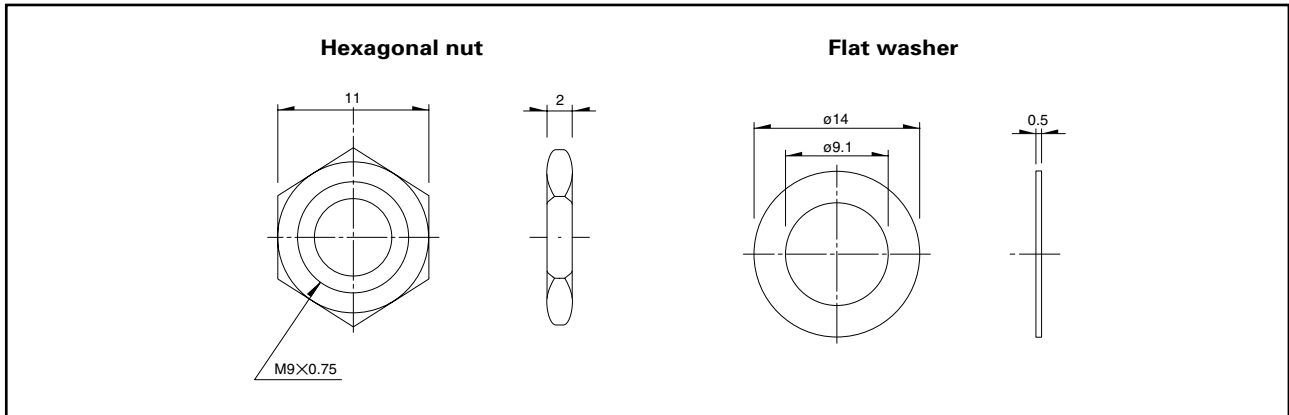

■ SRBM, SRRN

Unit:mm

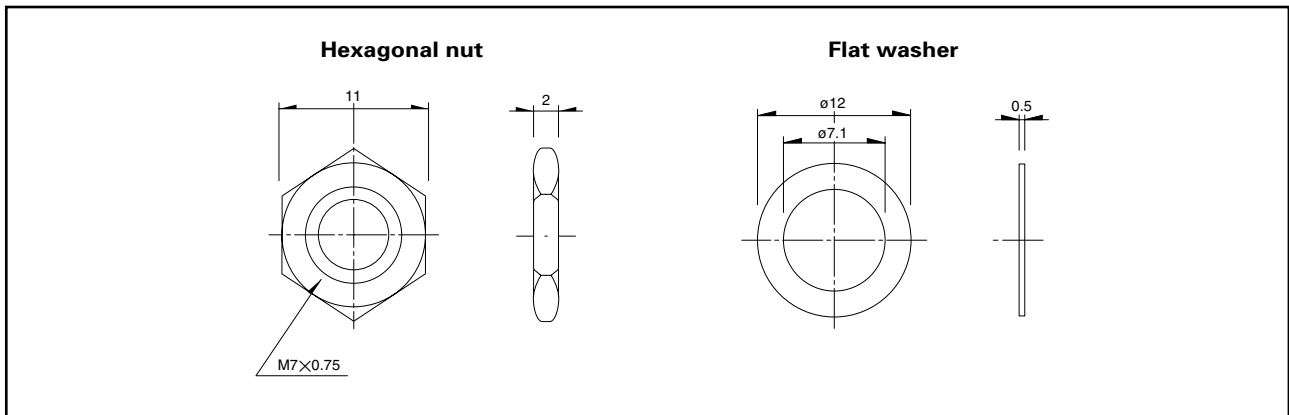

Detector

Push

Slide

Rotary

Encoders

Power

Dual-in-line
Package Type

TACT Switch™

Custom-
Products