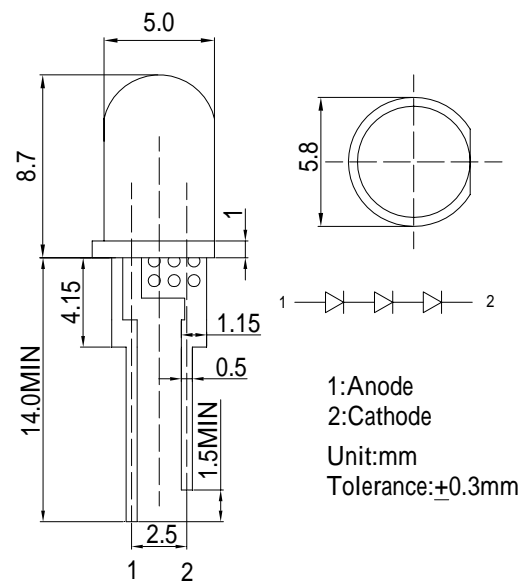

Features

- High Luminous LEDs
- 5mm Standard Directivity
- Superior Weather-resistance
- UV Resistant Epoxy
- Water Clear Type

Applications

- Traffic Signal
- Backlighting
- Signal And Channel Letter
- Other Lighting

Outline Dimension

Absolute Maximum Rating (Ta=25 °C)

Item	Symbol	Value	Unit
DC Forward Current	I_F	30	mA
Pulse Forward Current*	I_{FP}	120	mA
Reverse Voltage	V_R	15	V
Power Dissipation	P_D	216	mW
Operating Temperature	T_{opr}	-30 ~ +85	
Storage Temperature	T_{stg}	-40 ~ +100	
Lead Soldering Temperature	T_{sol}	260 /5sec	-

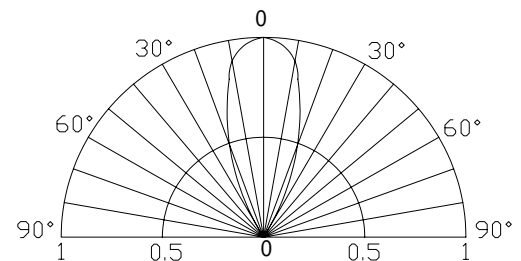
*Pulse width Max 10ms , Duty ratio max 1/10

Directivity

Electrical -Optical Characteristics (Ta=25 °C)

Item	Symbol	Condition	Min.	Typ.	Max.	Unit
DC Forward Voltage	V_F	$I_F=20mA$	5.4	6.3	7.2	V
DC Reverse Current	I_R	$V_R=15V$	-	-	10	μA
Domi Wavelength*	λ_D	$I_F=20mA$	619	624	629	nm
Luminous Intensity*	I_v	$I_F=20mA$	-	9000	-	mcd
50% Power Angle	$2\theta_{1/2}$	$I_F=20mA$	-	40	-	deg

*1 Tolerance of dominant wavelength is $\pm 1nm$

*2 Tolerance of luminous intensity is $\pm 15\%$