

Rectifier Diode SXXHNS/HRS100

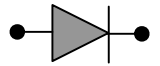

Symbol	Characteristics	Conditions	T _J (°C)	Value	Unit
BLOCKING PARAMETERS					
V _{RRM}	Repetitive peak reverse voltage		180	200-1500	V
I _{RRM}	Repetitive peak reverse current	V = V _{RRM}	180	20	mA
CONDUCTING PARAMETERS					
I _{F(AV)}	Average on-state current	180 sine, 50Hz, T _C = 130°C		100	A
I _{RMS}	RMS on-state current			160	A
I _{FSM}	Non repetitive peak surge on-state current	Sine wave, 10mS without reverse voltage	180	2400	A
I ² t	Permissible surge energy			28.8	kA ² S
V _{FM}	Peak on-state voltage drop	On-state current = 300A	180	1.30	V
V ₀	Typical forward conduction Threshold voltage		180	0.80	V
r ₀	Typical forward slope resistance		180	1.22	mΩ
THERMAL & MECHANICAL PARAMETERS					
R _{TH(J-C)}	Thermal impedance, 180° conduction, Sine	Junction to case		0.36	°C/W
R _{TH(C-HK)}	Thermal impedance	Case to heatsink		0.05	°C/W
T _J	Maximum Permissible junction temperature			180	°C
T _{STG}	Storage temperature range			-40 – 180	°C
F	Mounting Torque			13.5	NM
W	Weight			180	gms



HIND RECTIFIERS LTD

Rectifier Diode SXXHNS/HRS100

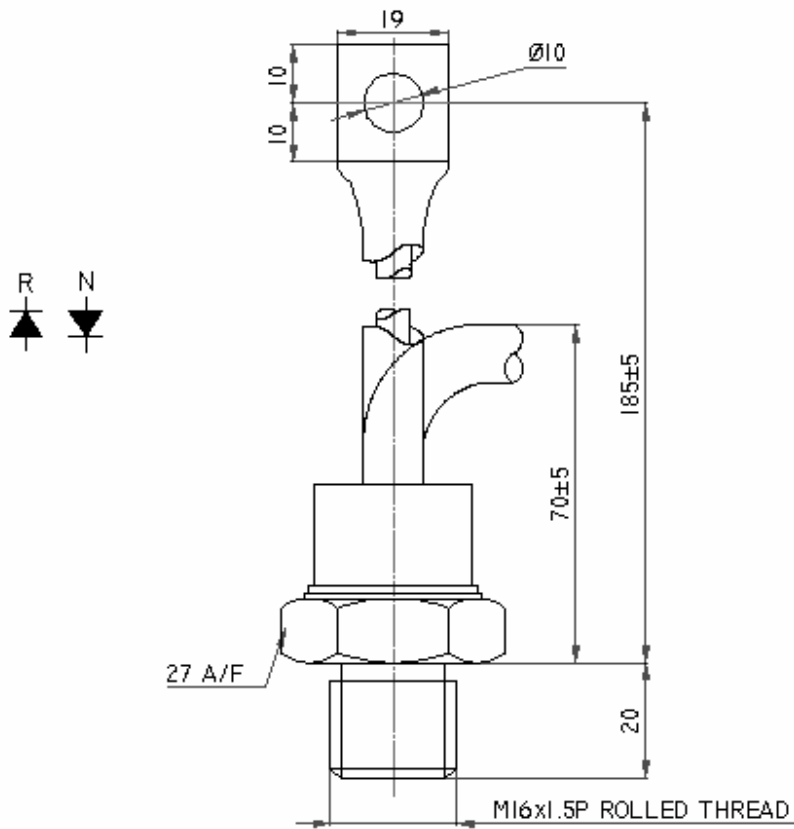
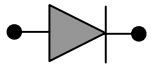

All dimensions in mm

On State Power Loss

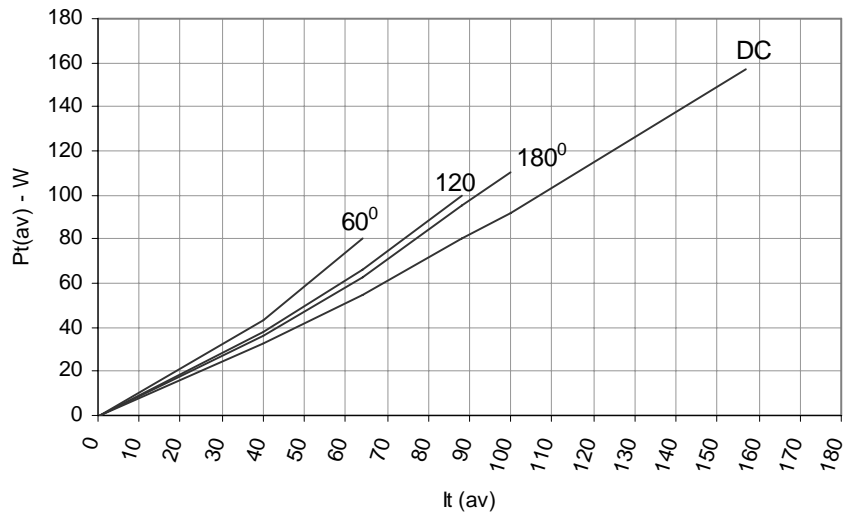

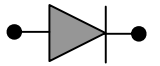

Maximum Permissible Case Temp

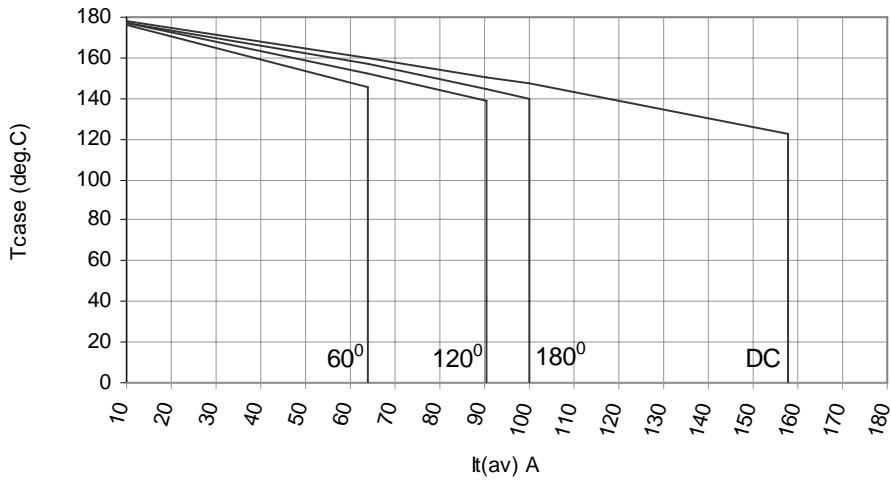

Max non repetitive Surge Current

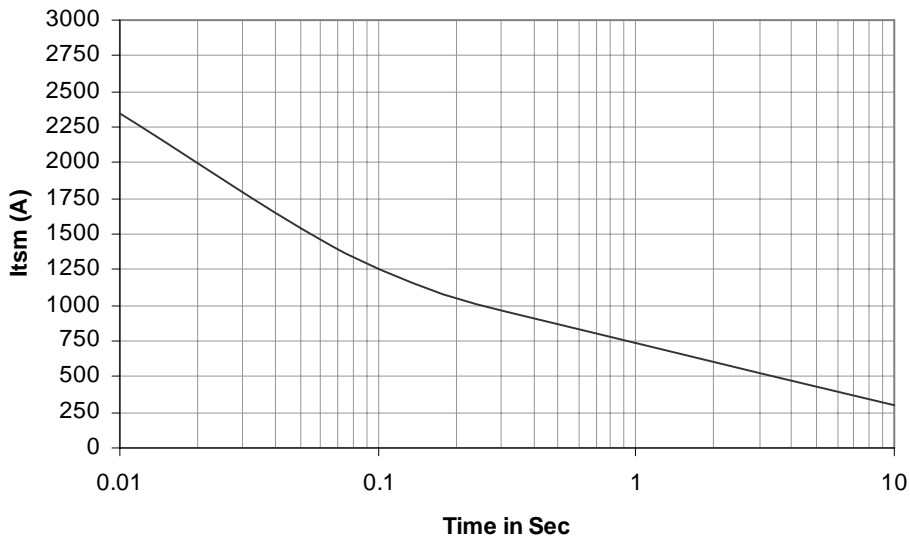

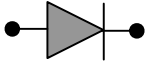

Transient Thermal Impedance Junction to Case

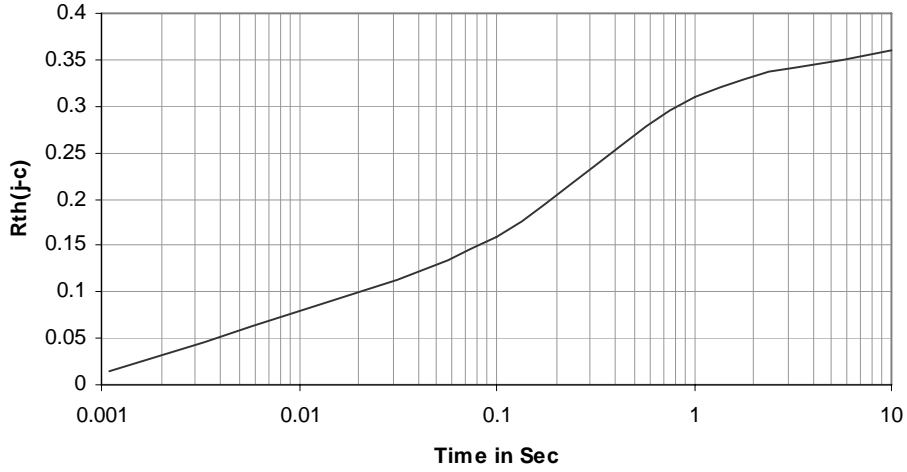

On State Characteristics

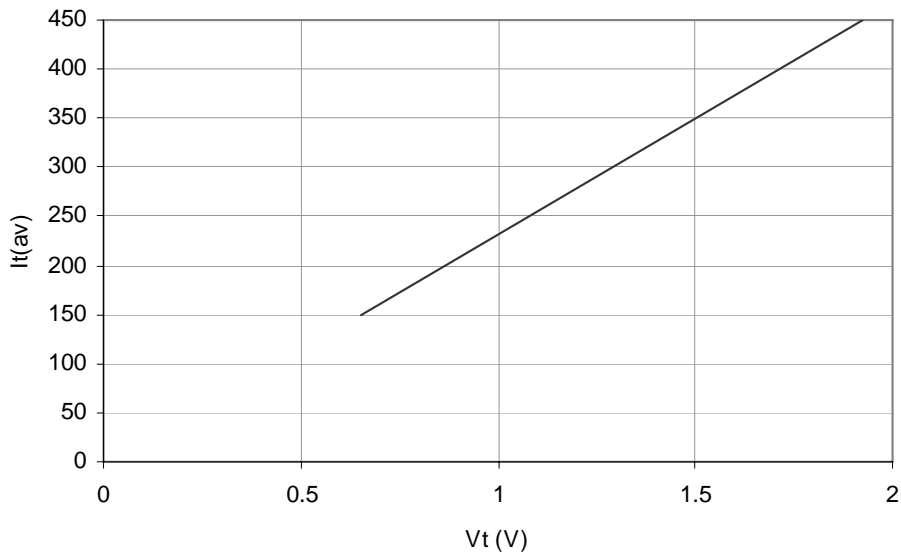

Rectifier Diode SXXHNS/HRS100

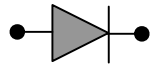

Ordering Information: -

S	XX	HNS / HRS	100
Hirect make Rectifier Diode	$V_{RRM} = XX * 100$ e.g. 12 * 100 = 1200V	HNS - Normal Polarity HRS - Reverse Polarity	$I_{F(AV)} = 100A$

Hind Rectifiers Ltd reserves the right to change the specifications without notice.

This datasheet specifies technical information for semiconductor devices but promises no characteristics. No warranty or guarantee expressed or implied is made regarding delivery, performance or suitability.

Hind Rectifiers Ltd
Lake Road
Bhandup (West)
Mumbai – 400 078
Tel: - +91 22 2596 8027/28/29/31
Fax: - +91 22 2596 4114
E-mail: - marketing@hirect.com
Website: - www.hirect.com

June-2008



HIND RECTIFIERS LTD

5 of 5