

HAT3018R, HAT3018RJ

Silicon N/P Channel Power MOS FET
High Speed Power Switching

REJ03G0127-0100Z
Rev.1.00
Oct.20.2003

Features

- Low on-resistance
- Capable of 4.5 V gate drive
- High density mounting
- “J” is for Automotive application
High temperature D-S leakage guarantee
Avalanche rating

Outline

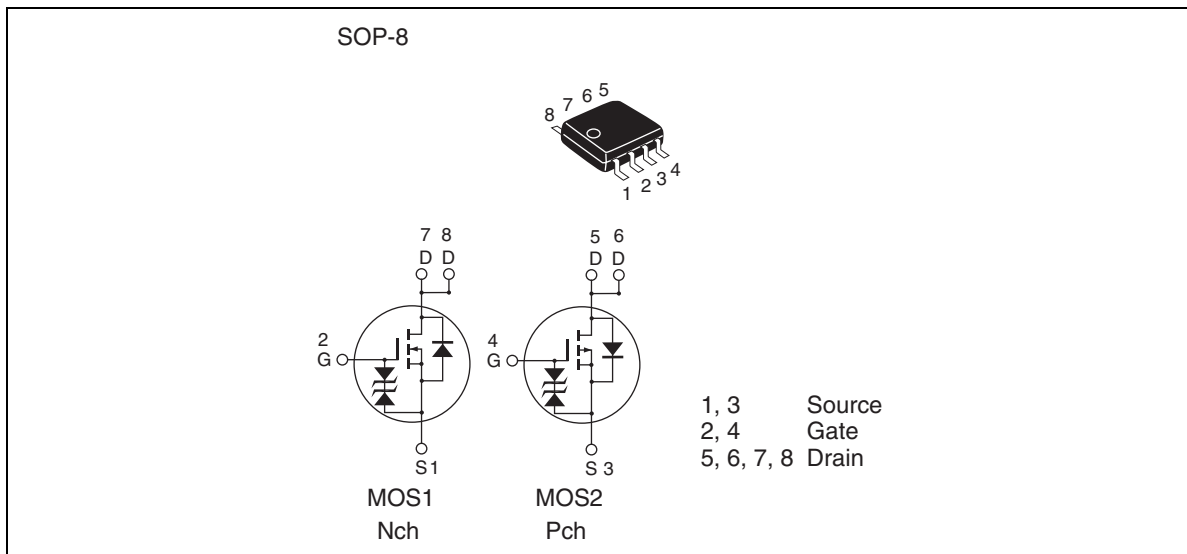

Absolute Maximum Ratings

(Ta = 25°C)

Item	Symbol	Ratings				Unit
		HAT3018R		HAT3018RJ		
		Nch	Pch	Nch	Pch	
Drain to source voltage	V _{DSS}	60	-60	60	-60	V
Gate to source voltage	V _{GSS}	±20	±20	±20	±20	V
Drain current	I _D	6	-5	6	-5	A
Drain peak current	I _D (pulse) ^{Note1}	48	-40	48	-40	A
Avalanche current	I _{AP} ^{Note4}	—	—	6	-5	A
Avalanche energy	E _{AR} ^{Note4}	—	—	3.08	2.14	mJ
Channel dissipation	P _{ch} ^{Note2}	2	2	2	2	W
Channel dissipation	P _{ch} ^{Note3}	3	3	3	3	W
Channel temperature	T _{ch}	150	150	150	150	°C
Storage temperature	T _{stg}	-55 to +150	-55 to +150	-55 to +150	-55 to +150	°C

Notes: 1. PW ≤ 10μs, duty cycle ≤ 1%

2. 1 Drive operation: When using the glass epoxy board (FR4 40 x 40 x 1.6 mm), PW ≤ 10 s

3. 2 Drive operation: When using the glass epoxy board (FR4 40 x 40 x 1.6 mm), PW ≤ 10 s

4. Value at T_{ch} = 25°C, R_g ≥ 50 Ω

Electrical Characteristics
• N Channel

(Ta = 25°C)

Item	Symbol	Min	Typ	Max	Unit	Test Conditions
Drain to source breakdown voltage	$V_{(BR)DSS}$	60	—	—	V	$I_D = 10 \text{ mA}$, $V_{GS} = 0$
Gate to Source breakdown voltage	$V_{(BR)GSS}$	± 20	—	—	V	$I_G = \pm 100 \text{ }\mu\text{A}$, $V_{DS} = 0$
Zero gate voltage drain current	I_{DSS}	—	—	1	μA	$V_{DS} = 60 \text{ V}$, $V_{GS} = 0$
Zero gate voltage drain current	HAT3018R	I_{DSS}	—	—	μA	$V_{DS} = 48 \text{ V}$, $V_{GS} = 0$
	HAT3018RJ	I_{DSS}	—	—	10	μA
Gate to source leak current	I_{GSS}	—	—	± 10	μA	$V_{GS} = \pm 16 \text{ V}$, $V_{DS} = 0$
Gate to source cutoff voltage	$V_{GS(off)}$	1.5	—	2.5	V	$V_{DS} = 10 \text{ V}$, $I_D = 1 \text{ mA}$
Forward transfer admittance	$ y_{fs} $	6	9.5	—	S	$I_D = 3 \text{ A}$ ^{Note 5} , $V_{DS} = 10 \text{ V}$
Static drain to source on state resistance	$R_{DS(on)}$	—	28	35	$\text{m}\Omega$	$I_D = 3 \text{ A}$ ^{Note 5} , $V_{GS} = 10 \text{ V}$
	$R_{DS(on)}$	—	40	50	$\text{m}\Omega$	$I_D = 3 \text{ A}$ ^{Note 5} , $V_{GS} = 4.5 \text{ V}$
Input capacitance	C_{iss}	—	1000	—	pF	$V_{DS} = 10 \text{ V}$, $V_{GS} = 0$
Output capacitance	C_{oss}	—	145	—	pF	$f = 1 \text{ MHz}$
Reverse transfer capacitance	C_{rss}	—	85	—	pF	
Total gate charge	Q_g	—	15	—	nC	$V_{DD} = 25 \text{ V}$
Gate to source charge	Q_{gs}	—	2	—	nC	$V_{GS} = 10 \text{ V}$
Gate to drain charge	Q_{gd}	—	3	—	nC	$I_D = 6 \text{ A}$
Turn-on delay time	$t_d(on)$	—	12	—	ns	$V_{GS} = 10 \text{ V}$, $I_D = 3 \text{ A}$
Rise time	t_r	—	10	—	ns	$V_{DD} \cong 30 \text{ V}$
Turn-off delay time	$t_d(off)$	—	60	—	ns	$R_L = 10 \text{ }\Omega$
Fall time	t_f	—	11	—	ns	$R_G = 4.7 \text{ }\Omega$
Body-drain diode forward voltage	V_{DF}	—	0.82	1.07	V	$I_F = 6 \text{ A}$, $V_{GS} = 0$ ^{Note 5}
Body-drain diode reverse recovery time	t_{rr}	—	40	—	ns	$I_F = 6 \text{ A}$, $V_{GS} = 0$ $diF/dt = 100\text{A}/\mu\text{s}$

Notes: 5. Pulse test

HAT3018R, HAT3018RJ

• P Channel

(Ta = 25°C)

Item	Symbol	Min	Typ	Max	Unit	Test Conditions
Drain to source breakdown voltage	$V_{(BR)DSS}$	-60	—	—	V	$I_D = -10 \text{ mA}$, $V_{GS} = 0$
Gate to Source breakdown voltage	$V_{(BR)GSS}$	± 20	—	—	V	$I_G = \pm 100 \text{ }\mu\text{A}$, $V_{DS} = 0$
Zero gate voltage drain current	I_{DSS}	—	—	-1	μA	$V_{DS} = -60 \text{ V}$, $V_{GS} = 0$
Zero gate voltage drain current	HAT3018R I_{DSS}	—	—	—	μA	$V_{DS} = -48 \text{ V}$, $V_{GS} = 0$
drain current	HAT3018RJ I_{DSS}	—	—	-10	μA	Ta = 125°C
Gate to source leak current	I_{GSS}	—	—	± 10	μA	$V_{GS} = \pm 16 \text{ V}$, $V_{DS} = 0$
Gate to source cutoff voltage	$V_{GS(off)}$	-1.0	—	-2.5	V	$V_{DS} = -10 \text{ V}$, $I_D = 1 \text{ mA}$
Forward transfer admittance	$ y_{fs} $	3	5	—	S	$I_D = -2.5 \text{ A}$ ^{Note 5} , $V_{DS} = -10 \text{ V}$
Static drain to source on state resistance	$R_{DS(on)}$	—	60	76	m Ω	$I_D = -2.5 \text{ A}$ ^{Note 5} , $V_{GS} = -10 \text{ V}$
	$R_{DS(on)}$	—	90	130	m Ω	$I_D = -2.5 \text{ A}$ ^{Note 5} , $V_{GS} = -4.5 \text{ V}$
Input capacitance	C_{iss}	—	1350	—	pF	$V_{DS} = -10 \text{ V}$, $V_{GS} = 0$
Output capacitance	C_{oss}	—	135	—	pF	f = 1 MHz
Reverse transfer capacitance	C_{rss}	—	85	—	pF	
Total gate charge	Q_g	—	21	—	nC	$V_{DD} = -25 \text{ V}$
Gate to source charge	Q_{gs}	—	3	—	nC	$V_{GS} = -10 \text{ V}$
Gate to drain charge	Q_{gd}	—	4	—	nC	$I_D = -5 \text{ A}$
Turn-on delay time	td(on)	—	20	—	ns	$V_{GS} = -10 \text{ V}$, $I_D = -2.5 \text{ A}$
Rise time	tr	—	15	—	ns	$V_{DD} \cong -30 \text{ V}$
Turn-off delay time	td(off)	—	55	—	ns	$R_L = 12 \text{ }\Omega$
Fall time	tf	—	10	—	ns	$R_G = 4.7 \text{ }\Omega$
Body-drain diode forward voltage	V_{DF}	—	-0.85	-1.10	V	$I_F = -5 \text{ A}$, $V_{GS} = 0$ ^{Note 5}
Body-drain diode reverse recovery time	trr	—	25	—	ns	$I_F = -5 \text{ A}$, $V_{GS} = 0$ $diF/dt = 100 \text{ A}/\mu\text{s}$

Notes: 5. Pulse test

Main Characteristics

• N Channel

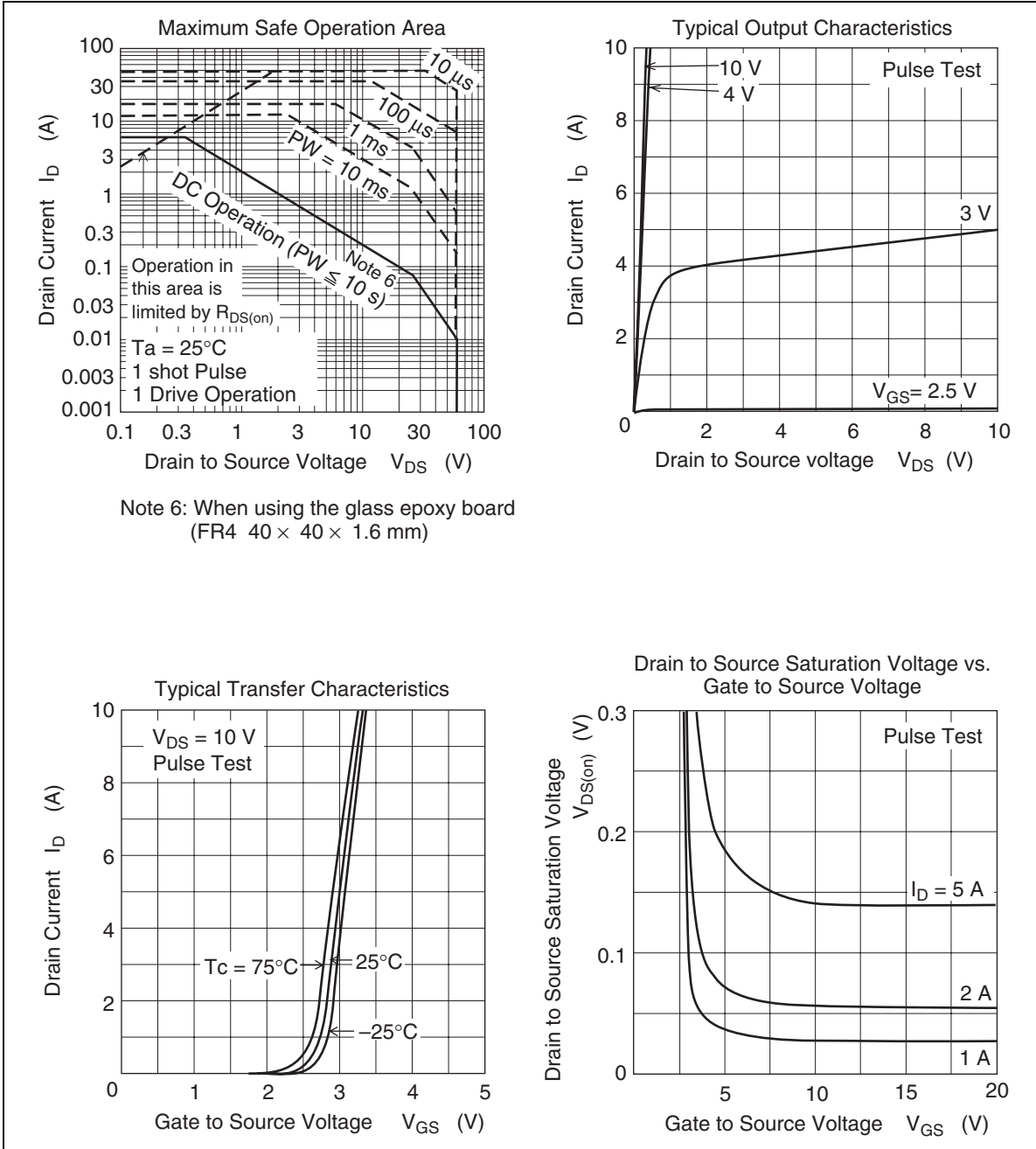

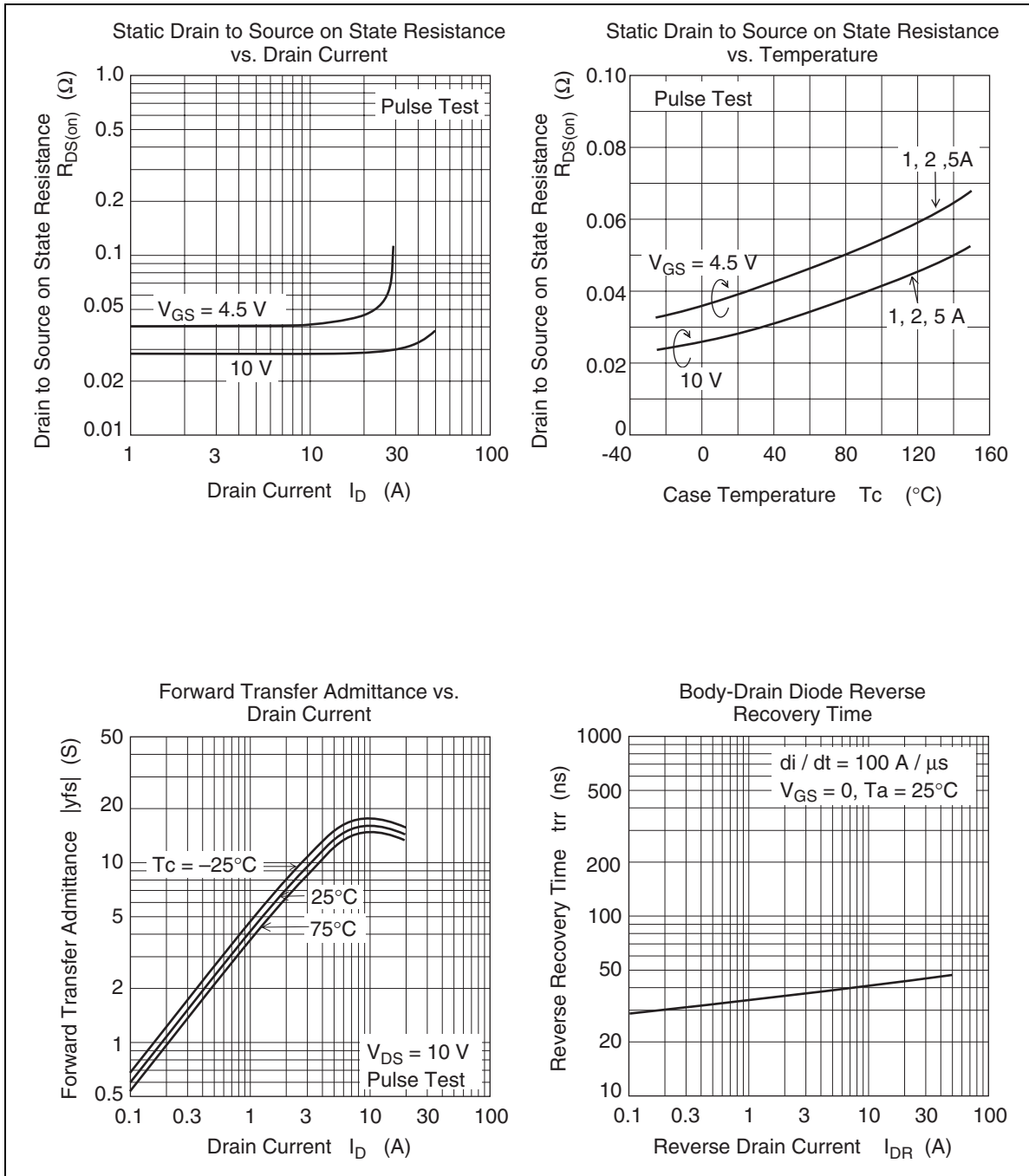

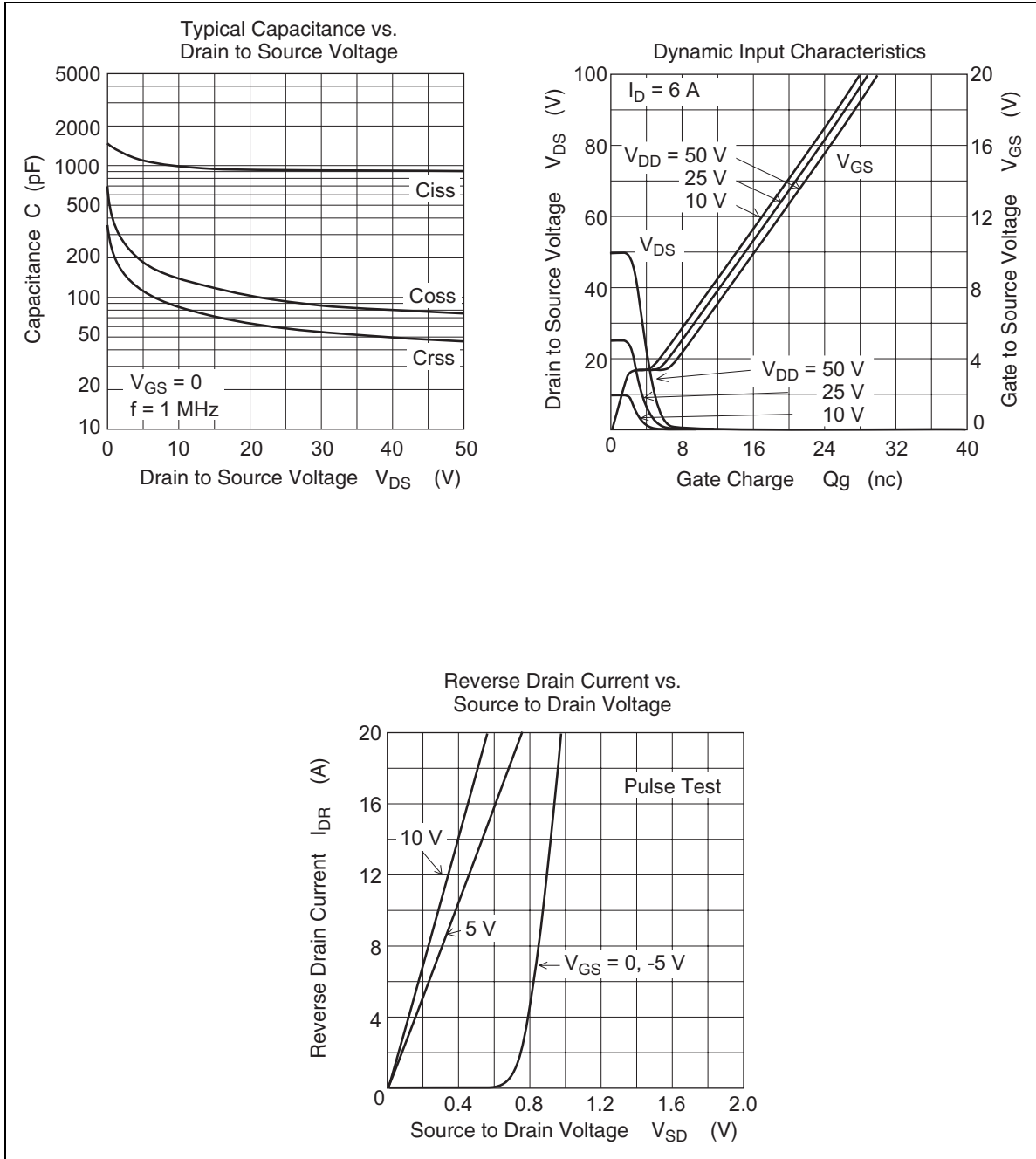

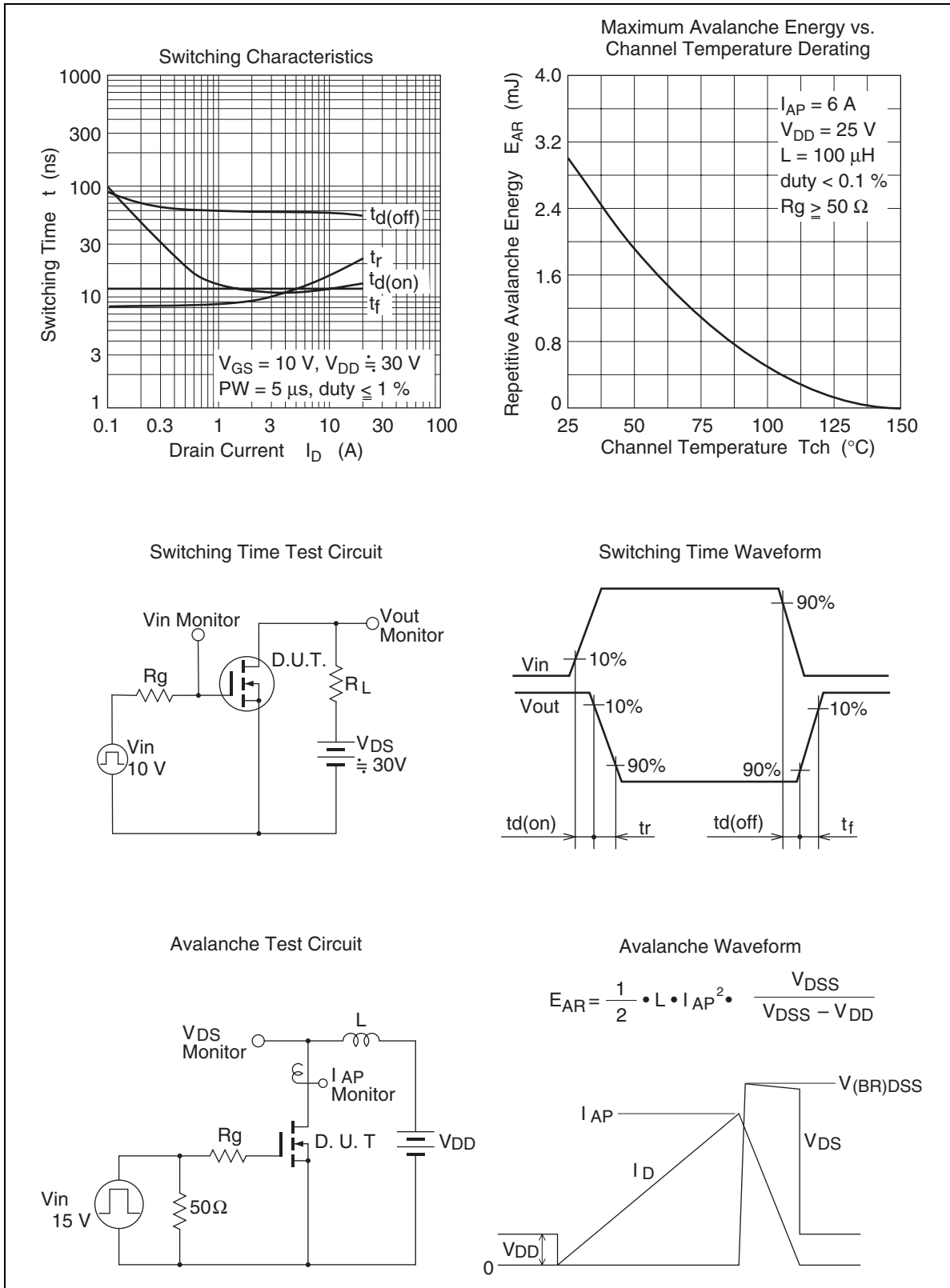

• P Channel

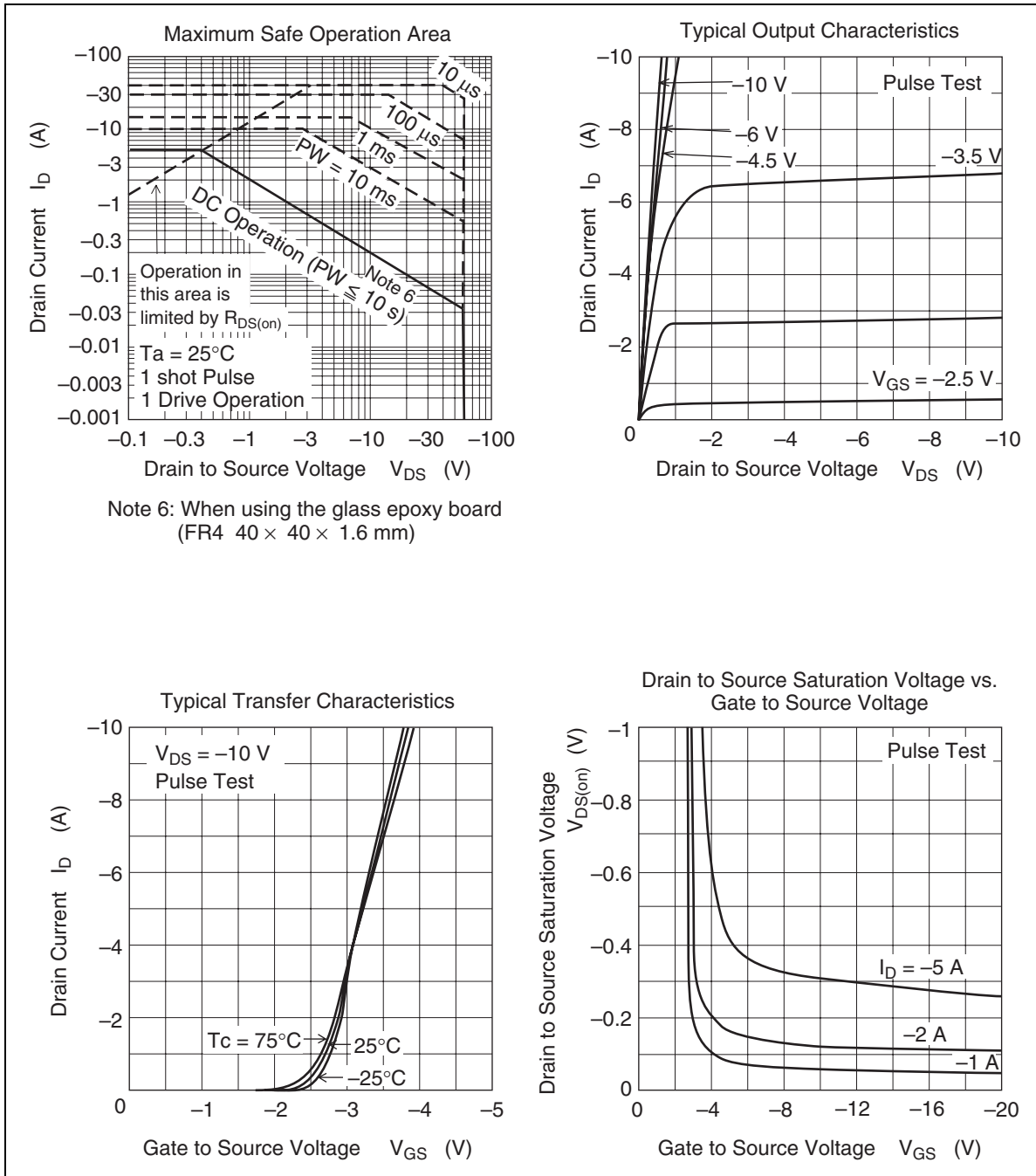

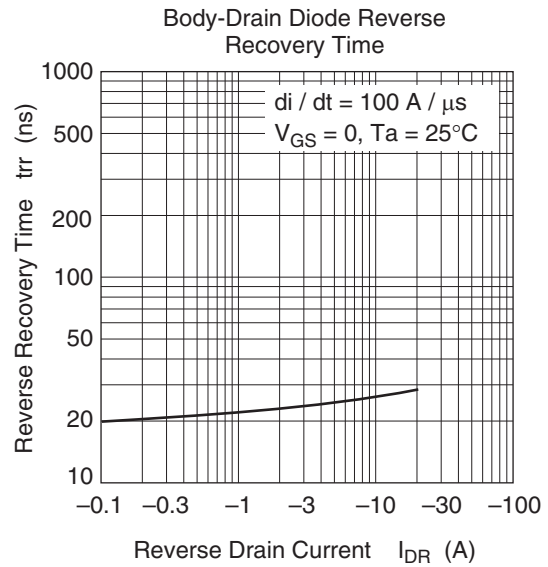
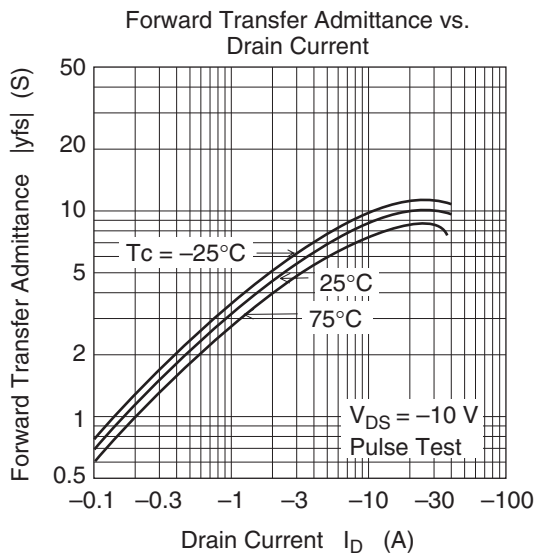
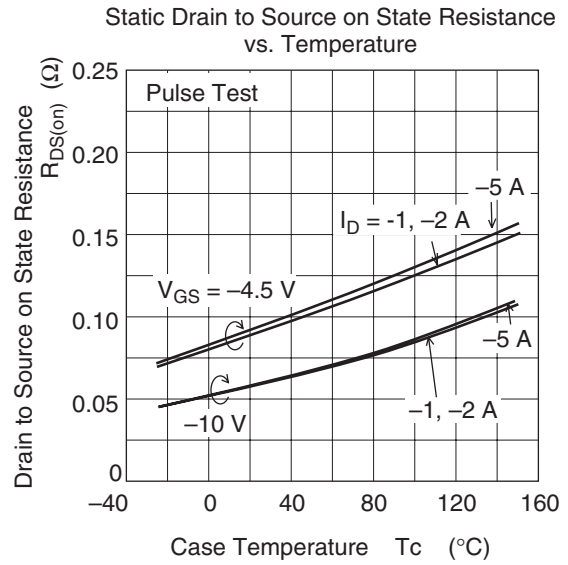
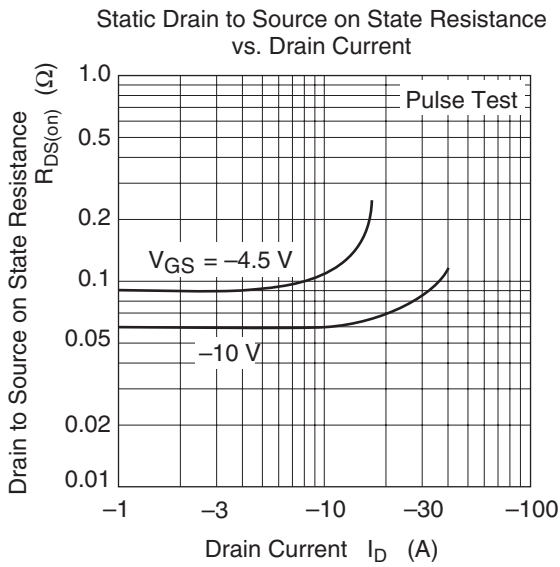

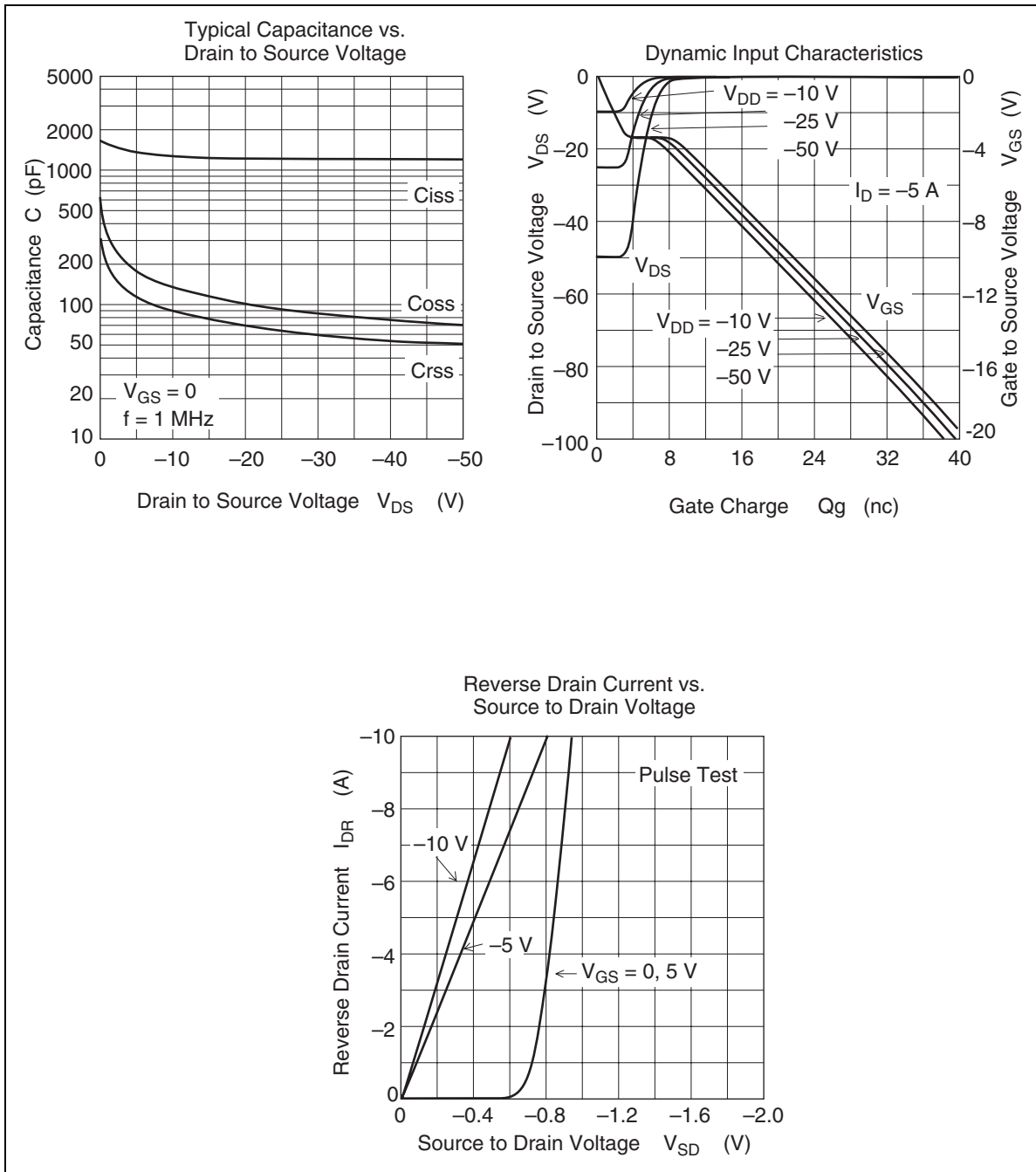

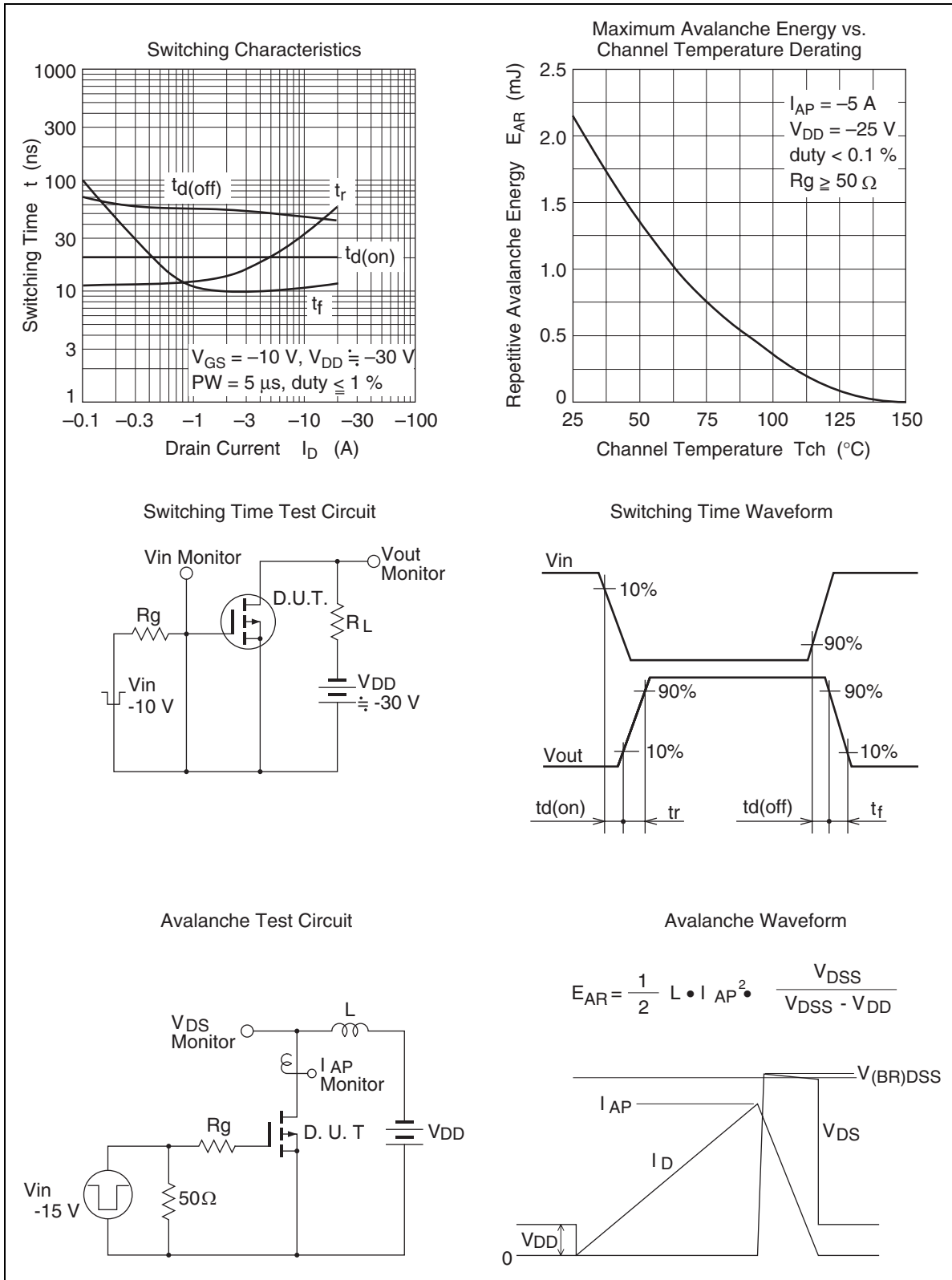

• In common

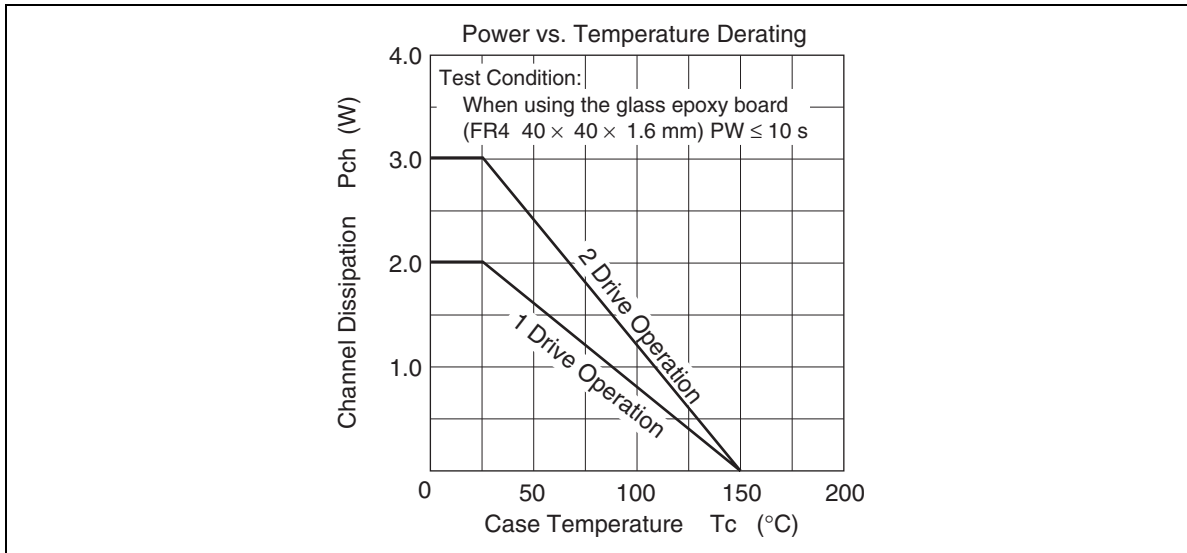

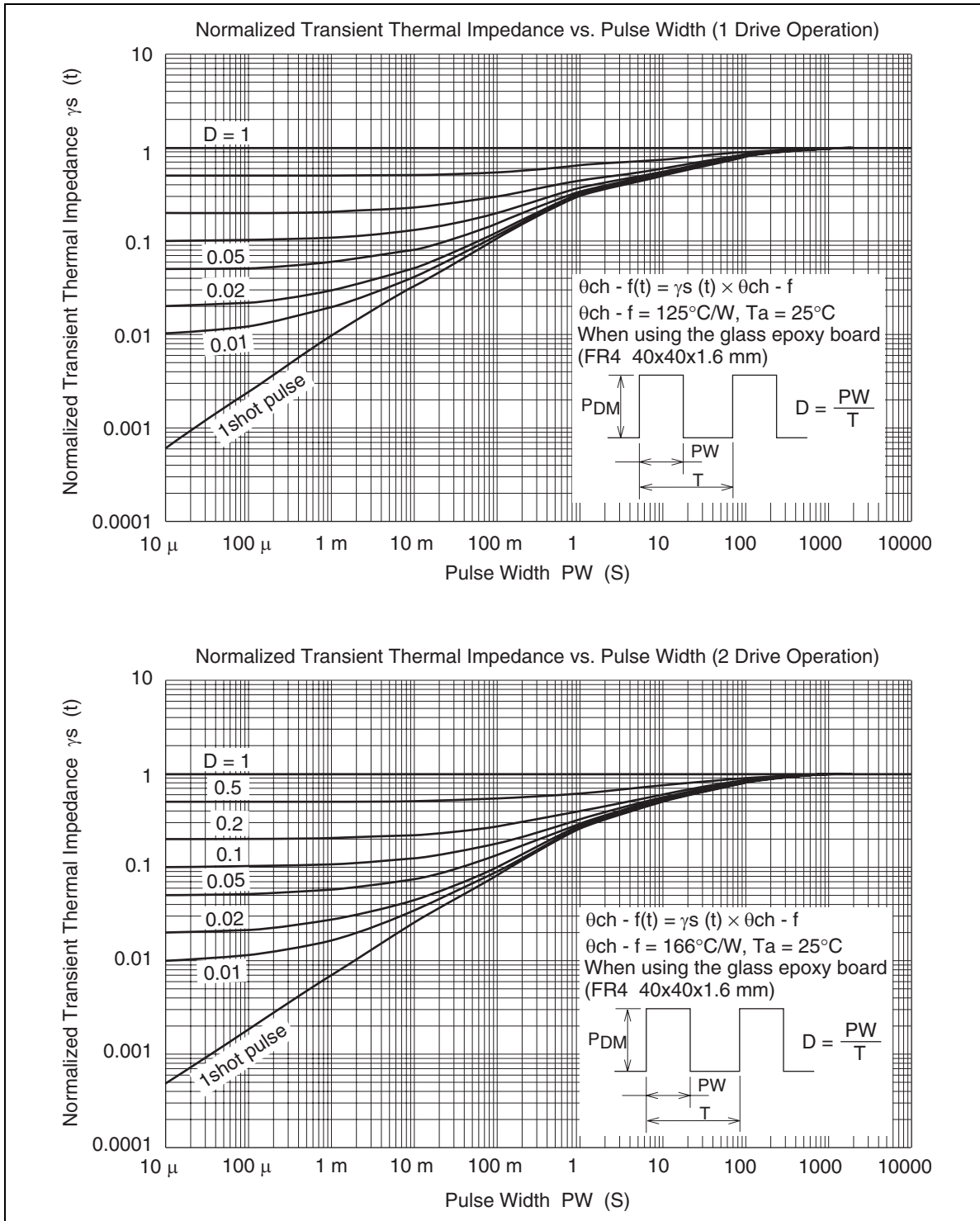

Package Dimensions

As of January, 2003
Unit: mm

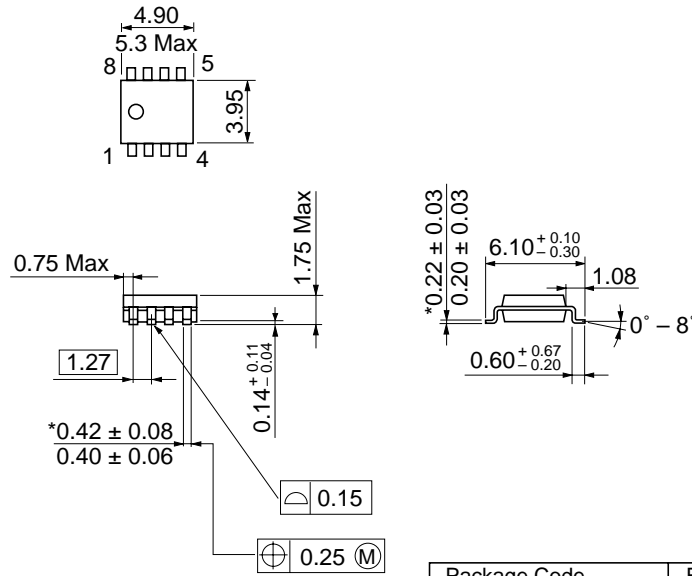

*Dimension including the plating thickness
Base material dimension

Package Code	FP-8DA
JEDEC	Conforms
JEITA	—
Mass (reference value)	0.085 g

RENESAS Technology Corp. Sales Strategic Planning Div. Nippon Bldg., 2-6-2, Ohte-machi, Chiyoda-ku, Tokyo 100-0004, Japan

Keep safety first in your circuit designs!

1. Renesas Technology Corp. puts the maximum effort into making semiconductor products better and more reliable, but there is always the possibility that trouble may occur with them. Trouble with semiconductors may lead to personal injury, fire or property damage.
Remember to give due consideration to safety when making your circuit designs, with appropriate measures such as (i) placement of substitutive, auxiliary circuits, (ii) use of nonflammable material or (iii) prevention against any malfunction or mishap.

Notes regarding these materials

1. These materials are intended as a reference to assist our customers in the selection of the Renesas Technology Corp. product best suited to the customer's application; they do not convey any license under any intellectual property rights, or any other rights, belonging to Renesas Technology Corp. or a third party.
 2. Renesas Technology Corp. assumes no responsibility for any damage, or infringement of any third-party's rights, originating in the use of any product data, diagrams, charts, programs, algorithms, or circuit application examples contained in these materials.
 3. All information contained in these materials, including product data, diagrams, charts, programs and algorithms represents information on products at the time of publication of these materials, and are subject to change by Renesas Technology Corp. without notice due to product improvements or other reasons. It is therefore recommended that customers contact Renesas Technology Corp. or an authorized Renesas Technology Corp. product distributor for the latest product information before purchasing a product listed herein.
The information described here may contain technical inaccuracies or typographical errors.
Renesas Technology Corp. assumes no responsibility for any damage, liability, or other loss rising from these inaccuracies or errors.
Please also pay attention to information published by Renesas Technology Corp. by various means, including the Renesas Technology Corp. Semiconductor home page (<http://www.renesas.com>).
 4. When using any or all of the information contained in these materials, including product data, diagrams, charts, programs, and algorithms, please be sure to evaluate all information as a total system before making a final decision on the applicability of the information and products. Renesas Technology Corp. assumes no responsibility for any damage, liability or other loss resulting from the information contained herein.
 5. Renesas Technology Corp. semiconductors are not designed or manufactured for use in a device or system that is used under circumstances in which human life is potentially at stake. Please contact Renesas Technology Corp. or an authorized Renesas Technology Corp. product distributor when considering the use of a product contained herein for any specific purposes, such as apparatus or systems for transportation, vehicular, medical, aerospace, nuclear, or undersea repeater use.
 6. The prior written approval of Renesas Technology Corp. is necessary to reprint or reproduce in whole or in part these materials.
 7. If these products or technologies are subject to the Japanese export control restrictions, they must be exported under a license from the Japanese government and cannot be imported into a country other than the approved destination.
Any diversion or reexport contrary to the export control laws and regulations of Japan and/or the country of destination is prohibited.
 8. Please contact Renesas Technology Corp. for further details on these materials or the products contained therein.
-



RENESAS SALES OFFICES

<http://www.renesas.com>

Renesas Technology America, Inc.
450 Holger Way, San Jose, CA 95134-1368, U.S.A
Tel: <1> (408) 382-7500 Fax: <1> (408) 382-7501

Renesas Technology Europe Limited.
Dukes Meadow, Millboard Road, Bourne End, Buckinghamshire, SL8 5FH, United Kingdom
Tel: <44> (1628) 585 100, Fax: <44> (1628) 585 900

Renesas Technology Europe GmbH
Dornacher Str. 3, D-85622 Feldkirchen, Germany
Tel: <49> (89) 380 70 0, Fax: <49> (89) 929 30 11

Renesas Technology Hong Kong Ltd.
7/F., North Tower, World Finance Centre, Harbour City, Canton Road, Hong Kong
Tel: <852> 2265-6688, Fax: <852> 2375-6836

Renesas Technology Taiwan Co., Ltd.
FL 10, #99, Fu-Hsing N. Rd., Taipei, Taiwan
Tel: <886> (2) 2715-2888, Fax: <886> (2) 2713-2999

Renesas Technology (Shanghai) Co., Ltd.
26/F., Ruijin Building, No.205 Maoming Road (S), Shanghai 200020, China
Tel: <86> (21) 6472-1001, Fax: <86> (21) 6415-2952

Renesas Technology Singapore Pte. Ltd.
1, Harbour Front Avenue, #06-10, Keppel Bay Tower, Singapore 098632
Tel: <65> 6213-0200, Fax: <65> 6278-8001