

Features

- 2.1mmx0.7mm RIGHT ANGLE SMT LED, 1.3mm THICKNESS.
- LOW POWER CONSUMPTION.
- WIDE VIEWING ANGLE.
- IDEAL FOR BACKLIGHT AND INDICATOR.
- VARIOUS COLORS AND LENS TYPES AVAILABLE.
- PACKAGE : 2000PCS / REEL.
- MOISTURE SENSITIVITY LEVEL : LEVEL 3.
- RoHS COMPLIANT.



Notes:

1. All dimensions are in millimeters (inches).
2. Tolerance is $\pm 0.15(0.006")$ unless otherwise noted.
- 3.Specifications are subject to change without notice.

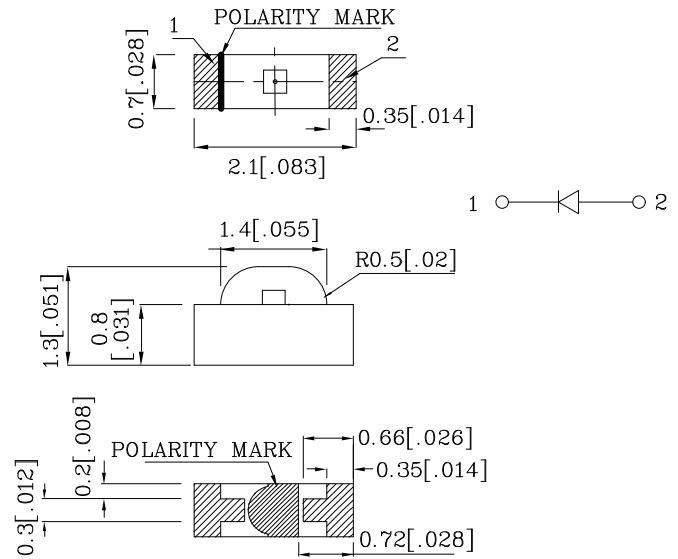

Absolute Maximum Ratings (TA=25°C)		MG (GaP)	Unit
Reverse Voltage	VR	5	V
Forward Current	IF	25	mA
Forward Current (Peak) 1/10 Duty Cycle 0.1ms Pulse Width	iFS	140	mA
Power Dissipation	PT	62.5	mW
Operating Temperature	TA	-40 ~ +85	°C
Storage Temperature	Tstg	-40 ~ +85	

Operating Characteristics (TA=25°C)		MG (GaP)	Unit
Forward Voltage (Typ.) (IF=20mA)	VF	2.2	V
Forward Voltage (Max.) (IF=20mA)	VF	2.5	V
Reverse Current (Max.) (VR=5V)	IR	10	uA
Wavelength Of Peak Emission (Typ.) (IF=20mA)	λP	565	nm
Wavelength Of Dominant Emission (Typ.) (IF=20mA)	λD	568	nm
Spectral Line Full Width At Half-Maximum (Typ.) (IF=20mA)	$\Delta\lambda$	30	nm
Capacitance (Typ.) (VF=0V, f=1MHz)	C	15	pF

Part Number	Emitting Color	Emitting Material	Lens-color	Luminous Intensity (IF=20mA) mcd		Wavelength nm λP	Viewing Angle 2 θ 1/2
				min.	typ.		
ZMG65W	Green	GaP	Water Clear	4	14	565	120 °

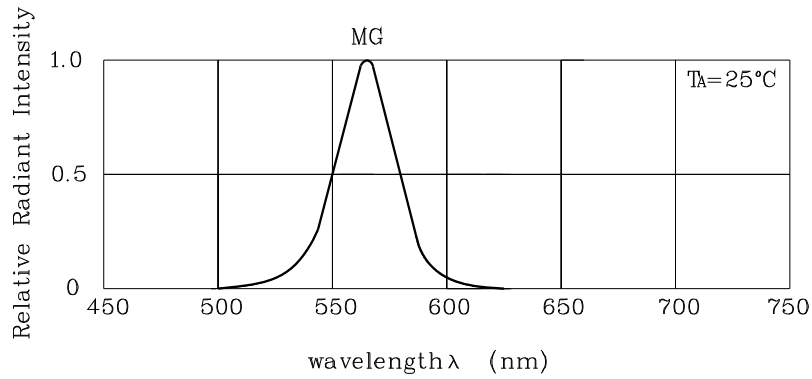

RELATIVE INTENSITY Vs. WAVELENGTH

❖ MG

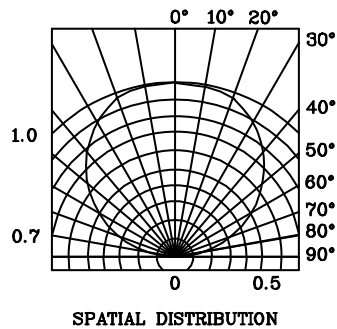
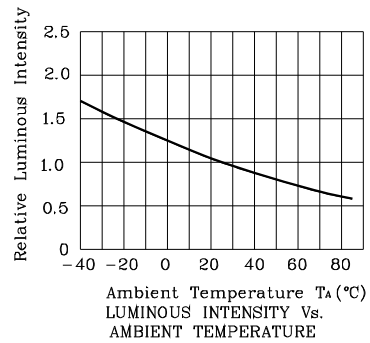
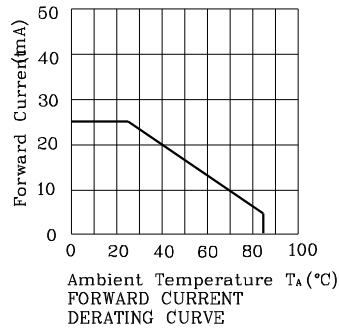
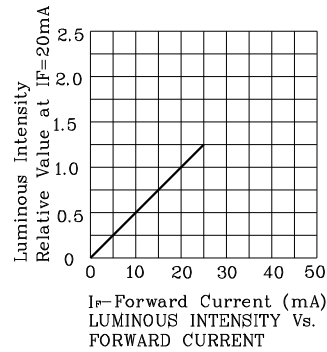
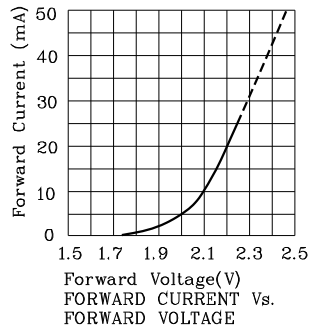

Reflow Soldering Profile For Lead-free SMT Process.

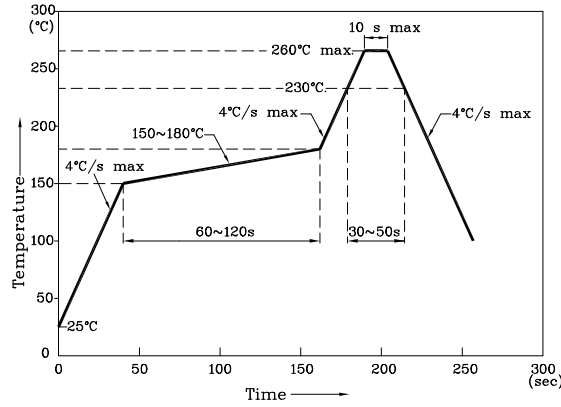

NOTES:

1. Maximum soldering temperature should not exceed 260°C.
2. Recommended reflow temperature: 145°C–260°C.
3. Do not put stress to the epoxy resin during high temperatures conditions.

❖ Recommended Soldering Pattern (Units : mm; Tolerance: ±0.1)

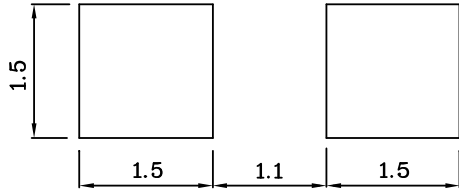

❖ The device has a single mounting surface. The device must be mounted according to the specifications.

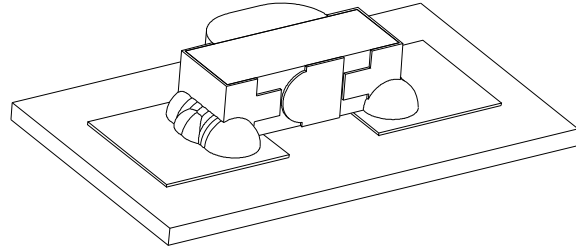

❖ Tape Specification (Units : mm)

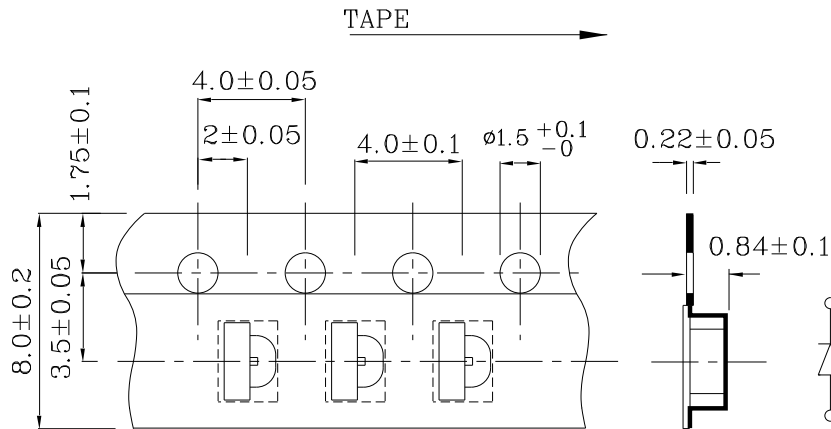

Remarks:

If special sorting is required (e.g. binning based on forward voltage, Luminous intensity / luminous flux, or wavelength), the typical accuracy of the sorting process is as follows:

1. Wavelength: +/-1nm
2. Luminous intensity / Luminous Flux: +/-15%
3. Forward Voltage: +/-0.1V

Note: Accuracy may depend on the sorting parameters.

PACKING & LABEL SPECIFICATIONS

ZMG65W

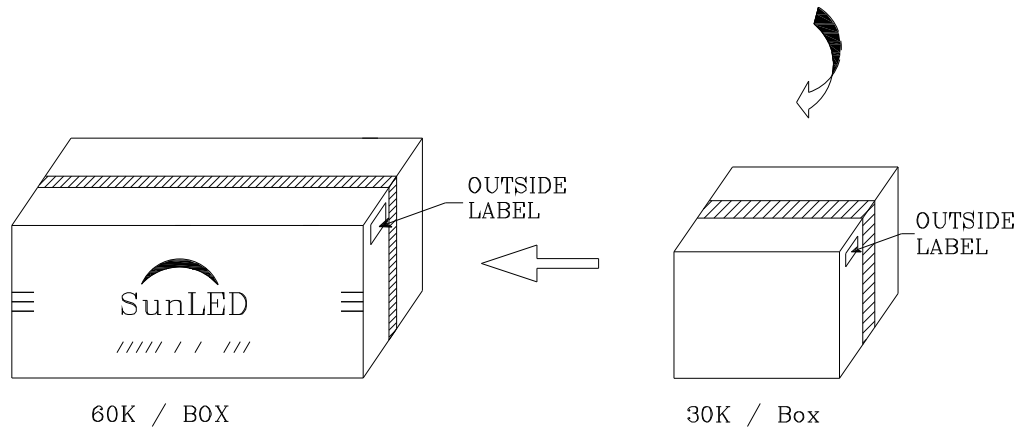
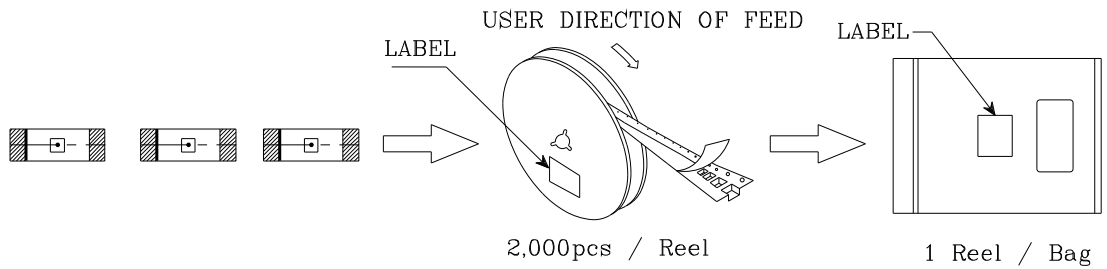

P/NO: Zxx65x	
QTY : 2,000 pcs	CODE: XXX
S/N : XX	
LOT NO:	
 xxxxxxxxxxxxxxxxxxxxxxxx	
RoHS Compliant	