

PRELIMINARY SPEC

Features

- 0.4 INCH CHARACTER HEIGHT.
- LOW CURRENT OPERATION.
- HIGH CONTRAST AND LIGHT OUTPUT.
- CATEGORIZED FOR LUMINOUS INTENSITY.
- MECHANICALLY RUGGED.
- GRAY FACE, WHITE SEGMENT.
- PACKAGE :250PCS / REEL.
- MOISTURE SENSITIVITY LEVEL : LEVEL 4.
- RoHS COMPLIANT.

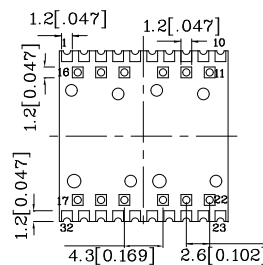
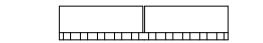
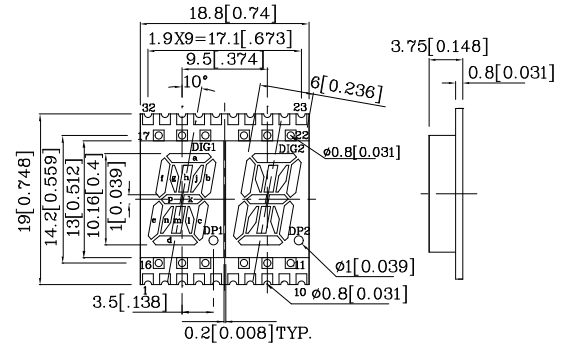
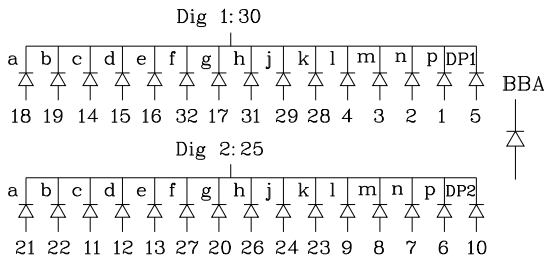

ATTENTION
OBSERVE PRECAUTIONS
FOR HANDLING
ELECTROSTATIC
DISCHARGE
SENSITIVE
DEVICES

Notes:

1. All dimensions are in millimeters (inches).
2. Tolerance is $\pm 0.25(0.01)$ unless otherwise noted.
- 3.Specifications are subject to change without notice.
- 4.The gap between the reflector and PCB shall not exceed 0.25mm.

Absolute Maximum Ratings (TA=25°C)		BBA (InGaN)	Unit
Reverse Voltage	VR	5	V
Forward Current	IF	30	mA
Forward Current (Peak) 1/10 Duty Cycle 0.1ms Pulse Width	iFS	100	mA
Power Dissipation	PT	120	mW
Operating Temperature	TA	-40 ~ +85	°C
Storage Temperature	Tstg	-40 ~ +85	
Electrostatic Discharge Threshold (HBM)		1000	V

Operating Characteristics (TA=25°C)		BBA (InGaN)	Unit
Forward Voltage (Typ.) (IF=10mA)	VF	3.05	V
Forward Voltage (Max.) (IF=10mA)	VF	4.0	V
Reverse Current (Max.) (VR=5V)	IR	10	uA
Wavelength Of Peak Emission (Typ.) (IF=10mA)	λP	468	nm
Wavelength Of Dominant Emission (Typ.) (IF=10mA)	λD	470	nm
Spectral Line Full Width At Half-Maximum (Typ.) (IF=10mA)	$\Delta\lambda$	21	nm
Capacitance (Typ.) (VF=0V, f=1MHz)	C	100	pF

Part Number	Emitting Color	Emitting Material	Luminous Intensity (IF=10mA) ucd	Wavelength nm λP	Description
			min.	typ.	
ZFABBA10C2	Blue	InGaN	800	2890	468 Common Cathode. Rt. Hand Decimal

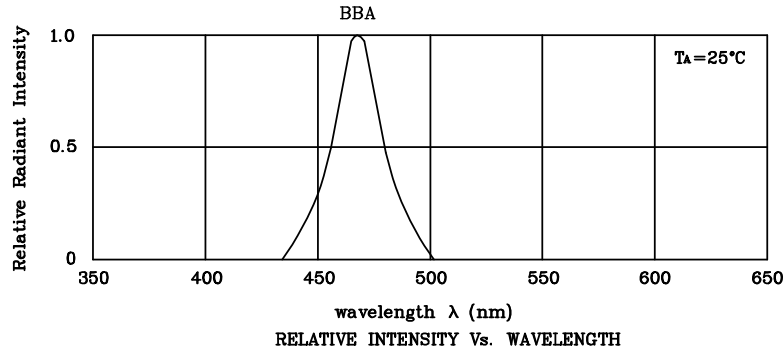

❖ **BBA**

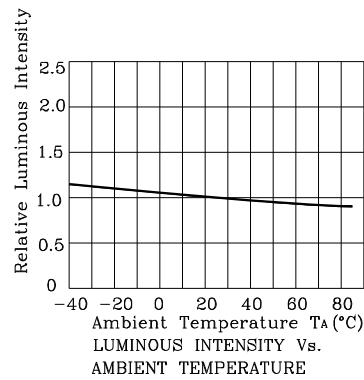
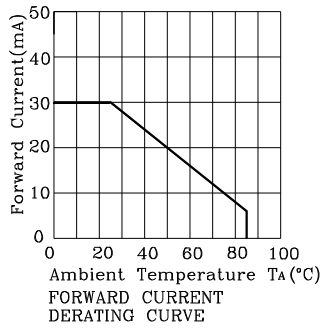
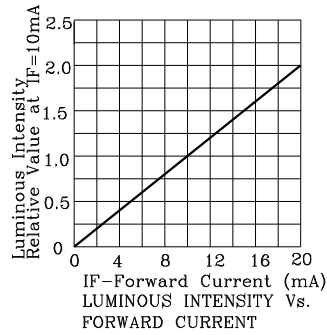
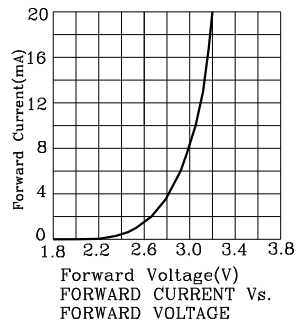

Remarks:

If special sorting is required (e.g. binning based on forward voltage, luminous intensity / luminous flux or wavelength), the typical accuracy of the sorting process is as follows:

1. Wavelength: +/-1nm
2. Luminous Intensity / Luminous Flux: +/-15%
3. Forward Voltage: +/-0.1V

Note: Accuracy may depend on the sorting parameters.

Reflow Soldering Profile For Lead-free SMT Process.

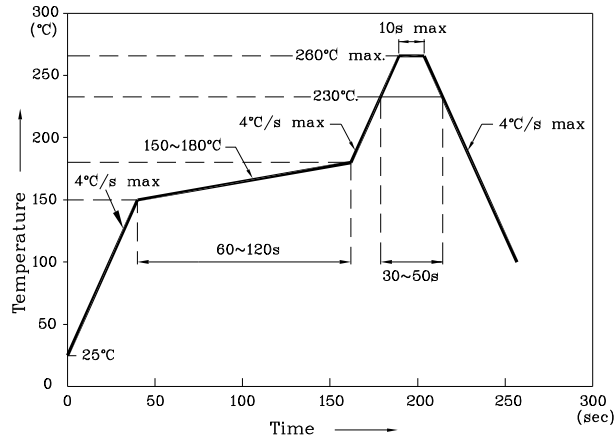

Notes:

1. Maximum soldering temperature should not exceed 260°C.
2. Recommended reflow temperature: 145°C-260°C.
3. Do not put stress to the epoxy resin during high temperatures conditions.

❖ Recommended Soldering Pattern (Units : mm;Tolerance:± 0.15)

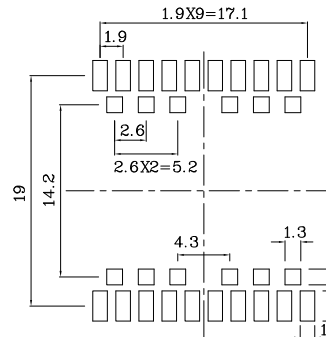

❖ Tape Specification (Units : mm)

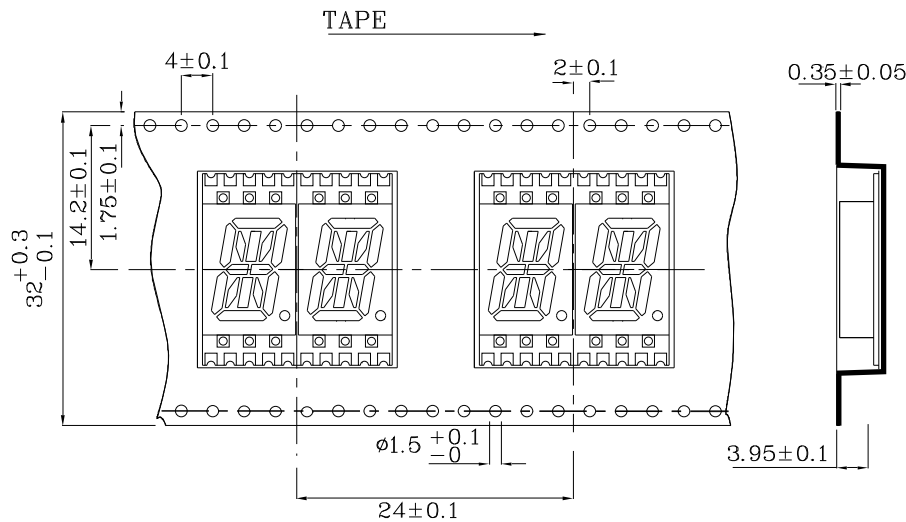



PACKING & LABEL SPECIFICATIONS ZFABBA10C2

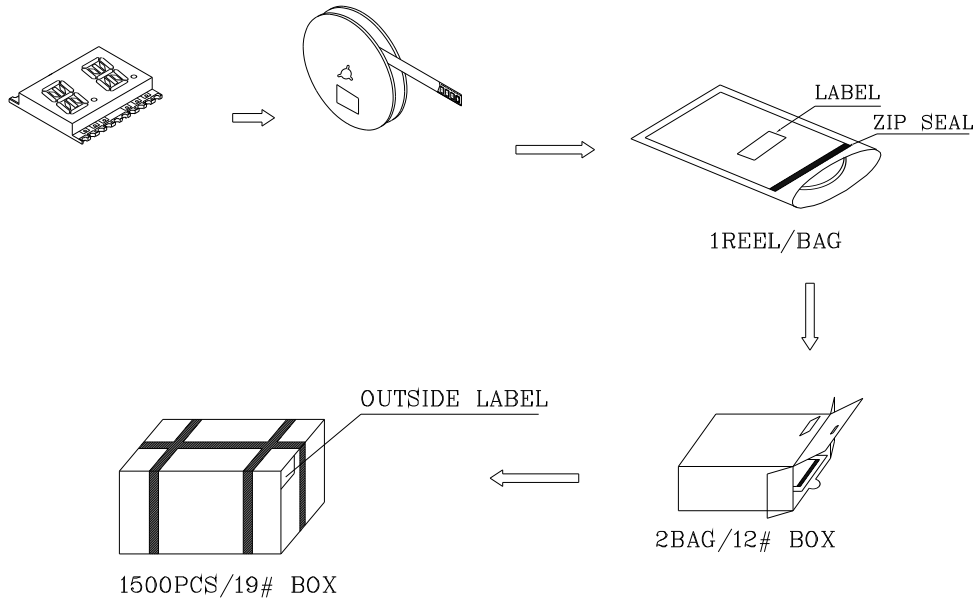

Outside LABEL Paste On The BAG

Inside LABEL Paste On The TAPE

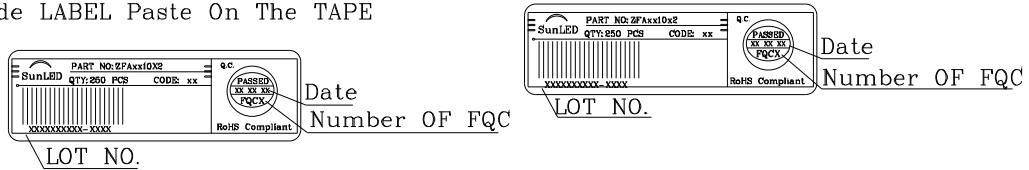

Outside LABEL Paste On The 19#Box

Outside LABEL Paste On The 12#Box

