

Features

- Peak Pulse Power: 600 W (10/1000 μ s)
- Breakdown voltage range:
From 6.8 V to 220 V
- Uni and Bidirectional types
- Low clamping factor
- Fast response time
- UL recognized

Description

The SM6T Transil series has been designed to protect sensitive equipment against electrostatic discharges according to IEC 61000-4-2, MIL STD 883E Method 3015, and electrical over stress such as IEC 61000-4-4 and 5. They are, more generally, suitable for surges below 600 W, 10/1000 μ s

This planar technology makes the SM6T compatible with high-end equipment and SMPS where low leakage current and high junction temperature are required to provide reliability and stability over time.

Automotive grade versions are available (see [Section 4: Ordering information](#)).

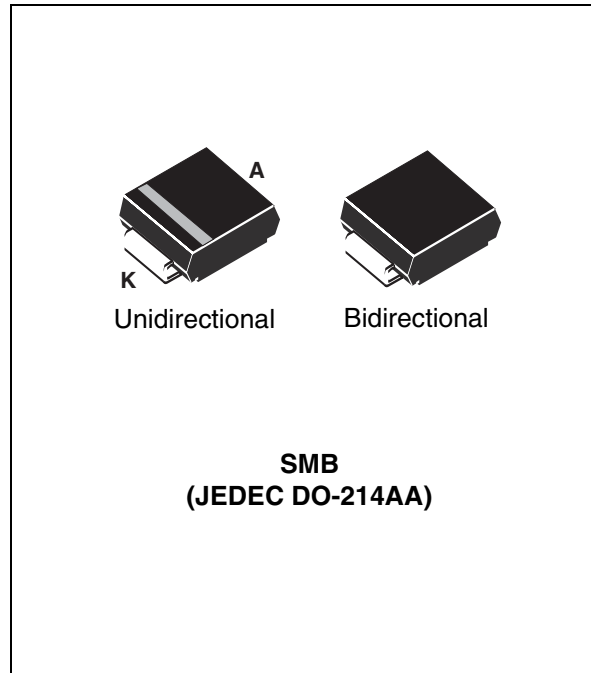

TM: Transil is a trademark of STMicroelectronics

1 Characteristics

Table 1. Absolute maximum ratings

Symbol	Parameter		Value	Unit
P_{PP}	Peak pulse power dissipation ⁽¹⁾	T_j initial = T_{amb}	600	W
P	Power dissipation on infinite heatsink	$T_{amb} = 50\text{ }^\circ\text{C}$	5	$^\circ\text{C}$
I_{FSM}	Non repetitive surge peak forward current for unidirectional types	$t_p = 10\text{ ms}$ T_j initial = T_{amb}	100	$^\circ\text{C}$
T_{stg} T_j	Storage temperature range Operating junction temperature range		-65 to 175 -55 to 150	$^\circ\text{C}$
T_L	Maximum lead temperature for soldering during 10 s.		260	$^\circ\text{C}$

1. For a surge greater than the maximum values, the diode will fail in short-circuit.

Table 2. Thermal resistance

Symbol	Parameter	Value	Unit
$R_{th(j-l)}$	Junction to leads	20	$^\circ\text{C/W}$
$R_{th(j-a)}$	Junction to ambient on printed circuit on recommended pad layout	100	$^\circ\text{C/W}$

Table 3. Electrical characteristics ($T_{amb} = 25\text{ }^\circ\text{C}$)

Symbol	Parameter
V_{RM}	Stand-off voltage
V_{BR}	Breakdown voltage
V_{CL}	Clamping voltage
I_{RM}	Leakage current
I_{PP}	Peak pulse current
αT	Voltage temperature coefficient
V_F	Forward voltage drop

Figure 1. Pulse definition for electrical characteristics

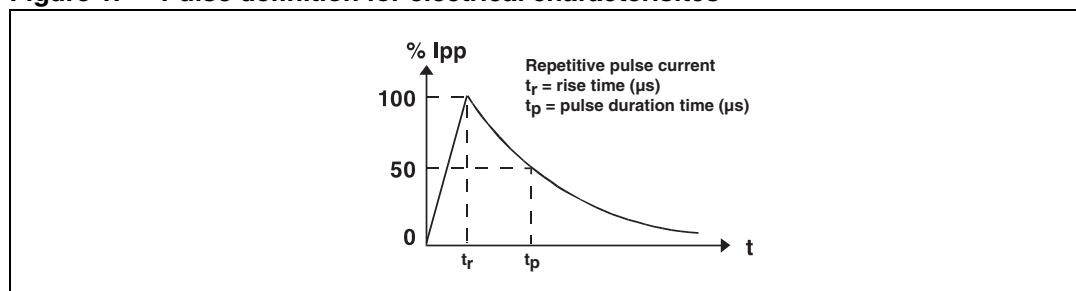

Table 4. Electrical characteristics, parameter values ($T_{amb} = 25\text{ }^{\circ}\text{C}$)

Order code	$I_{RM} @ V_{RM}^{(1)}$			$V_{BR} @ I_R^{(2)}$				$V_{CL} @ I_{PP}$ 10/1000 $\mu\text{s}^{(3)}$		$V_{CL} @ I_{PP}$ 8/20 $\mu\text{s}^{(3)}$		$\alpha T^{(4)}$	$C^{(5)}$
	max			min	nom	max		max		max		max	typ
	μA ($T_j=25^{\circ}\text{C}$)	μA ($T_j=85^{\circ}\text{C}$)	V	V	V	V	mA	V	A	V	A	$10^{-4}/^{\circ}\text{C}$	pF
SM6T6V8A/CA	10	50	5.8	6.45	6.8	7.14	10	10.5	57	13.4	298	5.7	4000
SM6T7V5A/CA	10	50	6.4	7.13	7.5	7.88	10	11.3	53	14.5	276	6.1	3700
SM6T10A/CA	1	10	8.55	9.5	10	10.5	1	14.5	41	18.6	215	7.3	2800
SM6T12A/CA	0.5	1	10.2	11.4	12	12.6	1	16.7	36	21.7	184	7.8	2300
SM6T15A/CA	0.5	1	12.8	14.3	15	15.8	1	21.2	28	27.2	147	8.4	1900
SM6T18A/CA	0.5	1	15.3	17.1	18	18.9	1	25.2	24	32.5	123	8.8	1600
SM6T22A/CA	0.5	1	18.8	20.9	22	23.1	1	30.6	20	39.3	102	9.2	1350
SM6T24A/CA	0.5	1	20.5	22.8	24	25.2	1	33.2	18	42.8	93	9.4	1250
SM6T27A/CA	0.5	1	23.1	25.7	27	28.4	1	37.5	16	48.3	83	9.6	1150
SM6T27AY ⁽⁶⁾	0.5	1	23.1	25.7	27	28.4	1	37.5	16	48.3	83	9.6	1150
SM6T30A/CA	0.5	1	25.6	28.5	30	31.5	1	41.5	14.5	53.5	75	9.7	1075
SM6T33A/CA	0.5	1	28.2	31.4	33	34.7	1	45.7	13.1	59.0	68	9.8	1000
SM6T36A/CA	0.5	1	30.8	34.2	36	37.8	1	49.9	12	64.3	62	9.9	950
SM6T36AY ⁽⁶⁾	0.5	1	30.8	34.2	36	37.8	1	49.9	12	64.3	62	9.9	950
SM6T39A/CA	0.5	1	33.3	37.1	39	41.0	1	53.9	11.1	69.7	57	10.0	900
SM6T39AY ⁽⁶⁾	0.5	1	33.3	37.1	39	41.0	1	53.9	11.1	69.7	57	10.0	900
SM6T68A/CA	0.5	1	58.1	64.6	68	71.4	1	92	6.5	121	33	10.4	625
SM6T75A/CA	0.5	1	64.1	71.3	75	78.8	1	103	5.8	134	30	10.5	575
SM6T100A/CA	0.5	1	85.5	95.0	100	105	1	137	4.4	178	22.5	10.6	500
SM6T150A/CA	0.5	1	128	143	150	158	1	207	2.9	265	15	10.8	400
SM6T200A/CA	0.5	1	171	190	200	210	1	274	2.2	353	11.3	10.8	350
SM6T220A/CA	0.5	1	188	209	220	231	1	328	2	388	10.3	10.8	330

1. For bidirectional types having $V_{RM} \leq 10\text{ V}$, I_{RM} shown should be multiplied by 2.

2. Pulse test: $t_p < 50\text{ ms}$

3. For pulse definition see [Figure 1](#).

4. $\Delta V_{BR} = \alpha T * (T_{amb} - 25) * V_{BR}(25\text{ }^{\circ}\text{C})$

5. $V_R = 0\text{ V}$, $F = 1\text{ MHz}$. For bidirectional types, capacitance value shown should be divided by 2.

6. Automotive grade version (qualified according to AEC Q101)

Figure 2. Peak power dissipation versus initial junction temperature (printed circuit board)

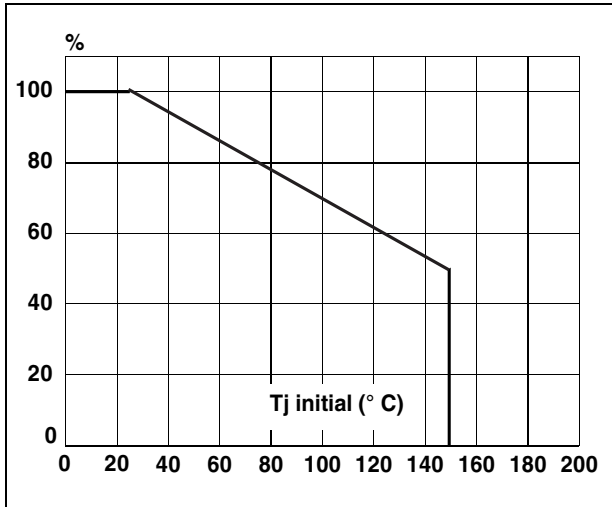

Figure 3. Peak pulse power versus exponential pulse duration

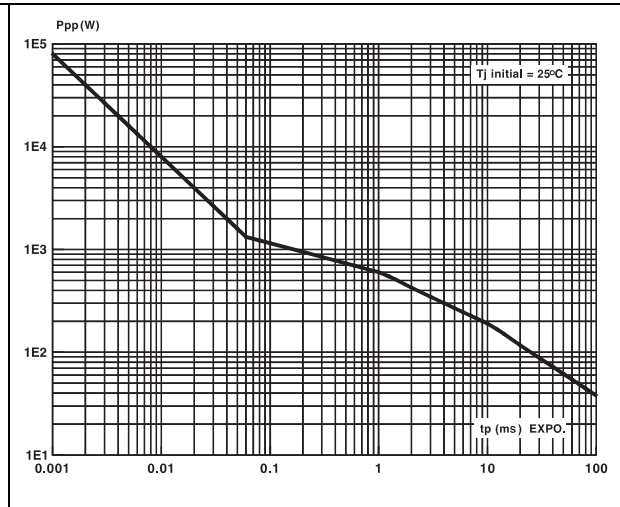
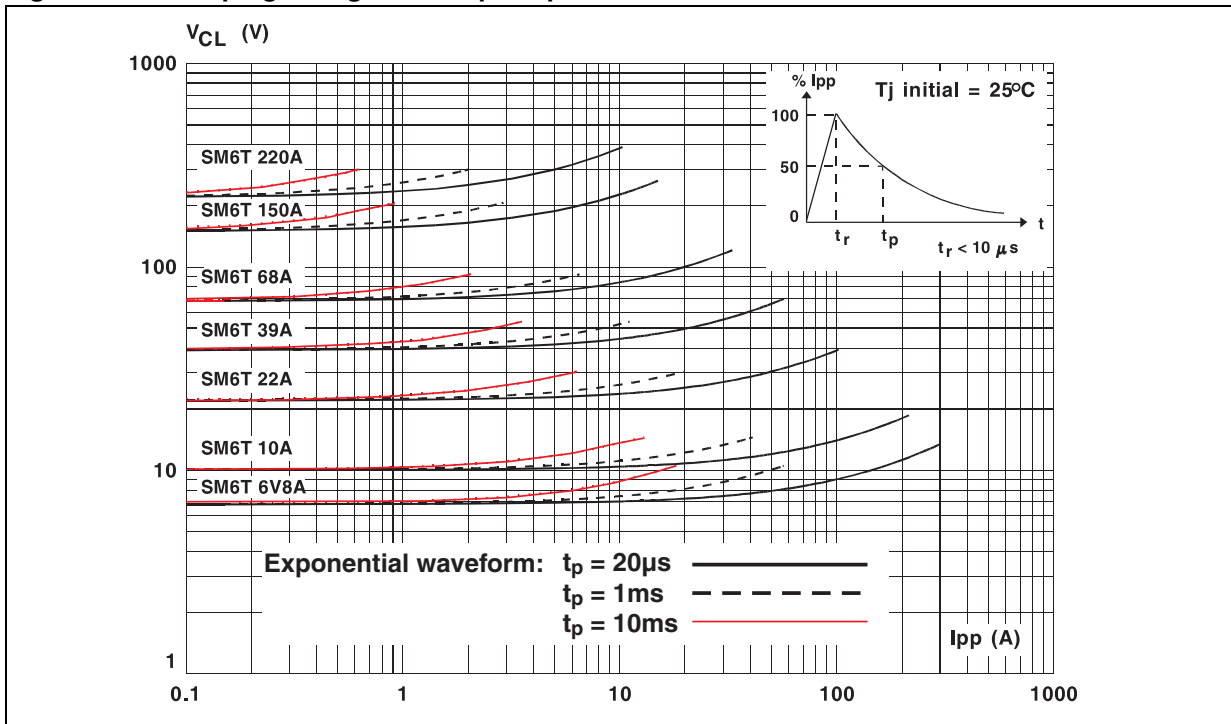

Figure 4. Clamping voltage versus peak pulse current(a)



a. The curves of Figure 4 are specified for a junction temperature of 25 °C before surge. The given results may be extrapolated for other junction temperatures by using the formula: $\Delta V_{BR} = \alpha T * [T_{amb} - 25] * V_{BR}(25 \text{ } ^\circ\text{C})$. For intermediate voltages, extrapolate the given results.

Figure 5. Capacitance versus reverse applied voltage for unidirectional types (typical values)

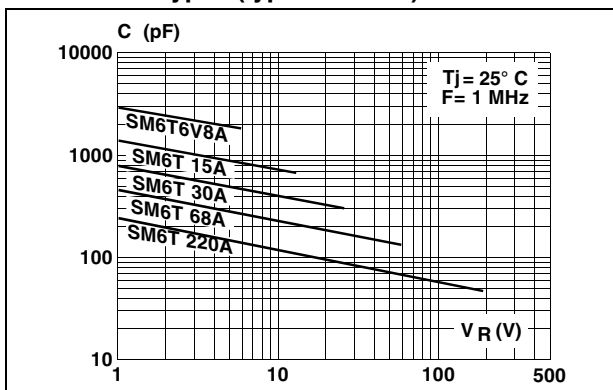

Figure 6. Capacitance versus reverse applied voltage for bidirectional types (typical values)

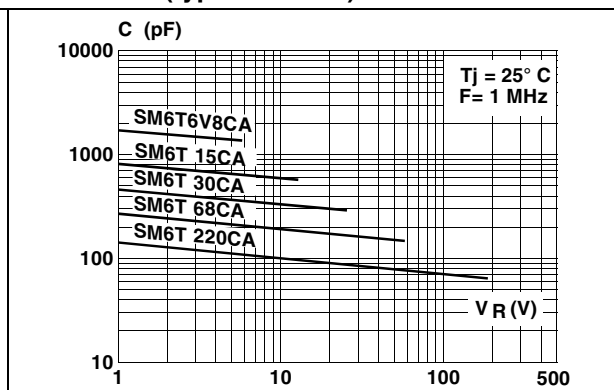

Figure 7. Peak forward voltage drop versus peak forward current for unidirectional types (typical values)

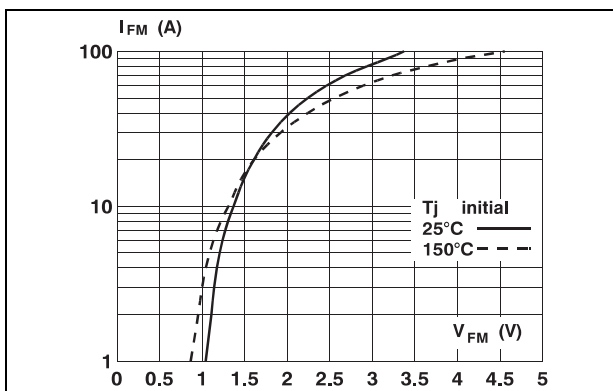

Figure 8. Transient thermal resistance junction to ambient versus pulse duration (printed circuit board FR4 e(Cu) = 35 μm)

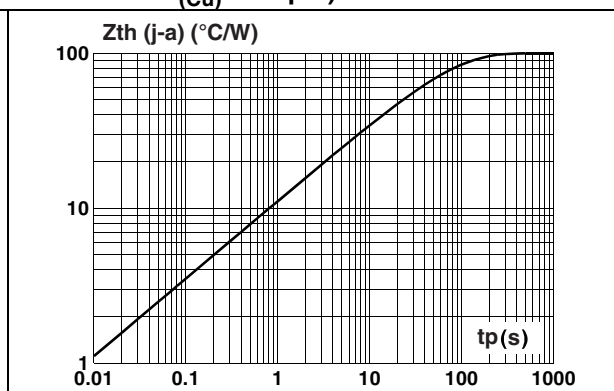
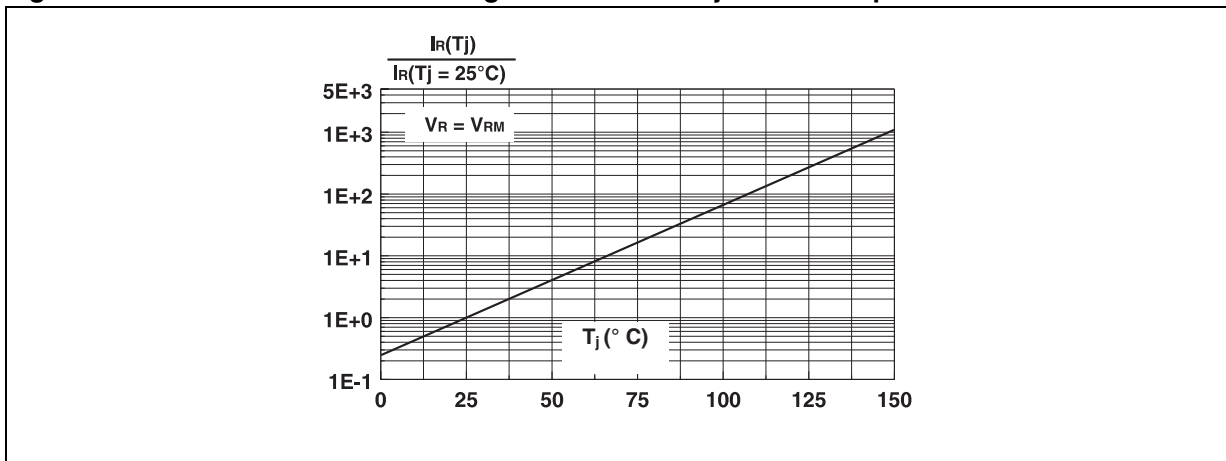
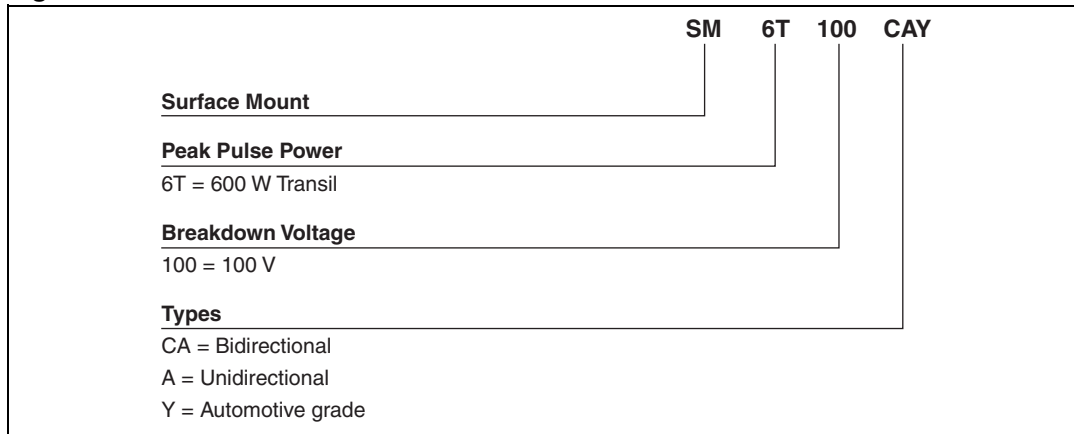

Figure 9. Relative variation of leakage current versus junction temperature



2 Order information scheme

Figure 10. Order information scheme



3 Packaging information

- Epoxy meets UL94, V0

In order to meet environmental requirements, ST offers these devices in ECOPACK® packages. These packages have a lead-free second level interconnect. The category of second level interconnect is marked on the package and on the inner box label, in compliance with JEDEC Standard JESD97. The maximum ratings related to soldering conditions are also marked on the inner box label. ECOPACK is an ST trademark. ECOPACK specifications are available at www.st.com.

Table 5. SMB package dimensions

Ref.	Dimensions			
	Millimeters		Inches	
	Min.	Max.	Min.	Max.
A1	1.90	2.45	0.075	0.096
A2	0.05	0.20	0.002	0.008
b	1.95	2.20	0.077	0.087
c	0.15	0.40	0.006	0.016
D	3.30	3.95	0.130	0.156
E	5.10	5.60	0.201	0.220
E1	4.05	4.60	0.159	0.181
L	0.75	1.50	0.030	0.059

Figure 11. SMB footprint dimensions in mm (inches)

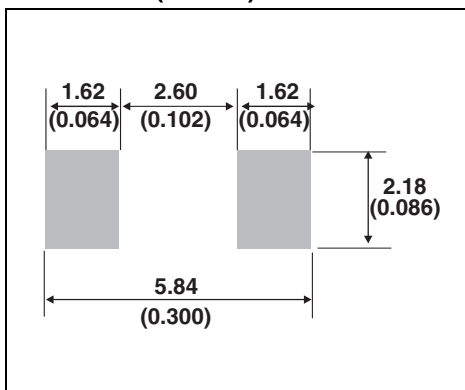

Figure 12. Marking layout

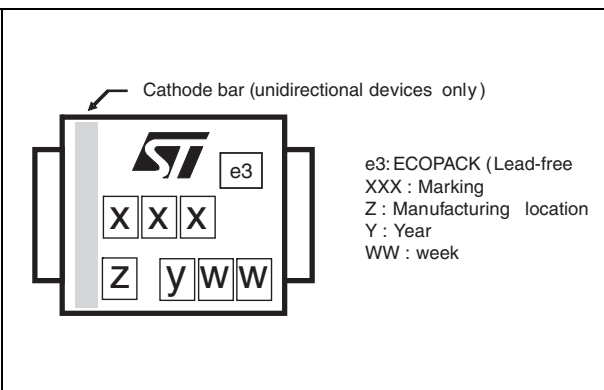

Table 6. Marking

Order code	Mark	Order code	Mark
SM6T6V8A	DE	SM6T6V8CA	LE
SM6T7V5A	DG	SM6T7V5CA	LG
SM6T10A	DP	SM6T10CA	LP
SM6T12A	DT	SM6T12CA	LT
SM6T15A	DX	SM6T15CA	LX
SM6T18A	EE	SM6T18CA	ME
SM6T22A	EK	SM6T22CA	MK
SM6T24A	EM	SM6T24CA	MM
SM6T27A	EP	SM6T27CA	MP
SM6T27AY ⁽¹⁾	EPY		
SM6T30A	ER	SM6T30CA	MR
SM6T33A	ET	SM6T33CA	MT
SM6T36A	EV	SM6T36CA	MV
SM6T36AY ⁽¹⁾	EVY		
SM6T39A	EX	SM6T39CA	MX
SM6T39AY ⁽¹⁾	EXY		
SM6T68A	FQ	SM6T68CA	NQ
SM6T75A	FS	SM6T75CA	NS
SM6T100A	FY	SM6T100CA	NY
SM6T150A	GL	SM6T150CA	OL
SM6T200A	GU	SM6T200CA	OU
SM6T220A	GW	SM6T220CA	OW

1. Automotive grade version (qualified according to AEC Q101)

4 Ordering information

Table 7. Ordering information

Order code	Marking	Package	Weight	Base qty	Delivery mode
SM6T	See Table 6 on page 7	SMB	0.12 g	5000	Tape and reel

5 Revision history

Table 8. Document revision history

Date	Revision	Changes
August-2001	4A	Previous update.
15-Sep-2004	5	1. Types table parameters on page 2: I_{RM} @ $T_j = 85$ °C condition added 2. I_{RM} max values changed
26-Mar-2008	6	Reformatted to current standard. SMB dimensions and footprint updated. Maximum junction temperature replaced with operating junction temperature range in Table 1 . Automotive grade versions indicated in Description section, in Table 4 and Table 6 .

Please Read Carefully:

Information in this document is provided solely in connection with ST products. STMicroelectronics NV and its subsidiaries ("ST") reserve the right to make changes, corrections, modifications or improvements, to this document, and the products and services described herein at any time, without notice.

All ST products are sold pursuant to ST's terms and conditions of sale.

Purchasers are solely responsible for the choice, selection and use of the ST products and services described herein, and ST assumes no liability whatsoever relating to the choice, selection or use of the ST products and services described herein.

No license, express or implied, by estoppel or otherwise, to any intellectual property rights is granted under this document. If any part of this document refers to any third party products or services it shall not be deemed a license grant by ST for the use of such third party products or services, or any intellectual property contained therein or considered as a warranty covering the use in any manner whatsoever of such third party products or services or any intellectual property contained therein.

UNLESS OTHERWISE SET FORTH IN ST'S TERMS AND CONDITIONS OF SALE ST DISCLAIMS ANY EXPRESS OR IMPLIED WARRANTY WITH RESPECT TO THE USE AND/OR SALE OF ST PRODUCTS INCLUDING WITHOUT LIMITATION IMPLIED WARRANTIES OF MERCHANTABILITY, FITNESS FOR A PARTICULAR PURPOSE (AND THEIR EQUIVALENTS UNDER THE LAWS OF ANY JURISDICTION), OR INFRINGEMENT OF ANY PATENT, COPYRIGHT OR OTHER INTELLECTUAL PROPERTY RIGHT.

UNLESS EXPRESSLY APPROVED IN WRITING BY AN AUTHORIZED REPRESENTATIVE OF ST, ST PRODUCTS ARE NOT DESIGNED, AUTHORIZED OR WARRANTED FOR USE IN MILITARY, AIR CRAFT, SPACE, LIFE SAVING, OR LIFE SUSTAINING APPLICATIONS, NOR IN PRODUCTS OR SYSTEMS, WHERE FAILURE OR MALFUNCTION MAY RESULT IN PERSONAL INJURY, DEATH, OR SEVERE PROPERTY OR ENVIRONMENTAL DAMAGE.

Resale of ST products with provisions different from the statements and/or technical features set forth in this document shall immediately void any warranty granted by ST for the ST product or service described herein and shall not create or extend in any manner whatsoever, any liability of ST.

ST and the ST logo are trademarks or registered trademarks of ST in various countries.

Information in this document supersedes and replaces all information previously supplied.

The ST logo is a registered trademark of STMicroelectronics. All other names are the property of their respective owners.

© 2008 STMicroelectronics - All rights reserved

STMicroelectronics group of companies

Australia - Belgium - Brazil - Canada - China - Czech Republic - Finland - France - Germany - Hong Kong - India - Israel - Italy - Japan - Malaysia - Malta - Morocco - Singapore - Spain - Sweden - Switzerland - United Kingdom - United States of America

www.st.com