

Silicon PNP Power Transistors

2SA1488 2SA1488A

DESCRIPTION

- With TO-220F package
- Complement to type 2SC3851/3851A

APPLICATIONS

- Audio and general purpose

PINNING

PIN	DESCRIPTION
1	Base
2	Collector
3	Emitter

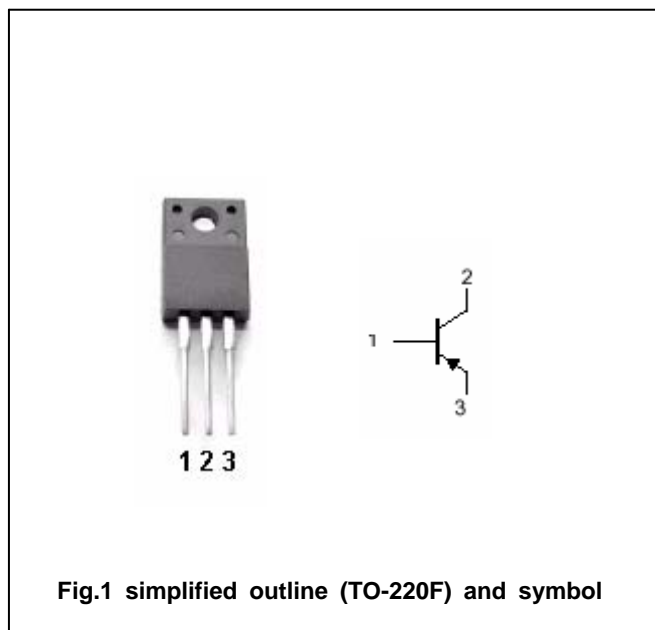

Fig.1 simplified outline (TO-220F) and symbol

Absolute maximum ratings (Ta=25°C)

SYMBOL	PARAMETER	CONDITIONS	VALUE	UNIT
V _{CBO}	Collector-base voltage	2SA1488	-60	V
		2SA1488A	-80	
V _{CEO}	Collector-emitter voltage	2SA1488	-60	V
		2SA1488A	-80	
V _{EBO}	Emitter-base voltage	Open collector	-6	V
I _C	Collector current		-4	A
I _B	Base current		-1	A
P _C	Collector dissipation	T _C =25°C	25	W
T _j	Junction temperature		150	°C
T _{stg}	Storage temperature		-55~150	°C

Silicon PNP Power Transistors

2SA1488 2SA1488A

CHARACTERISTICS

T_j=25°C unless otherwise specified

SYMBOL	PARAMETER	CONDITIONS	MIN	TYP.	MAX	UNIT
V _{(BR)CEO}	Collector-emitter breakdown voltage	2SA1488	I _C =-25mA ; I _B =0	-60		V
		2SA1488A		-80		
V _{CEsat}	Collector-emitter saturation voltage	I _C =-2.0A; I _B =-0.2A			-0.5	V
I _{CBO}	Collector cut-off current	2SA1488	V _{CB} =-60V; I _E =0		-0.1	mA
		2SA1488A		V _{CB} =-80V; I _E =0		
I _{EBO}	Emitter cut-off current	V _{EB} =-6V; I _C =0			-0.1	mA
h _{FE}	DC current gain	I _C =-1A ; V _{CE} =-4V	40			
f _T	Transition frequency	I _C =-0.2A ; V _{CE} =-12V		15		MHz
C _{OB}	Output capacitance	I _E =0 ; V _{CB} =-10V; f=1MHz		90		pF

Switching time

t _{on}	Turn-on time	I _C =-2.0A; I _{B1} =-I _{B2} =-0.2A V _{CC} =-12V , R _L =6 Ω		0.25		μ s
t _s	Storage time			0.75		μ s
t _f	Fall time			0.25		μ s

Silicon PNP Power Transistors

2SA1488 2SA1488A

PACKAGE OUTLINE

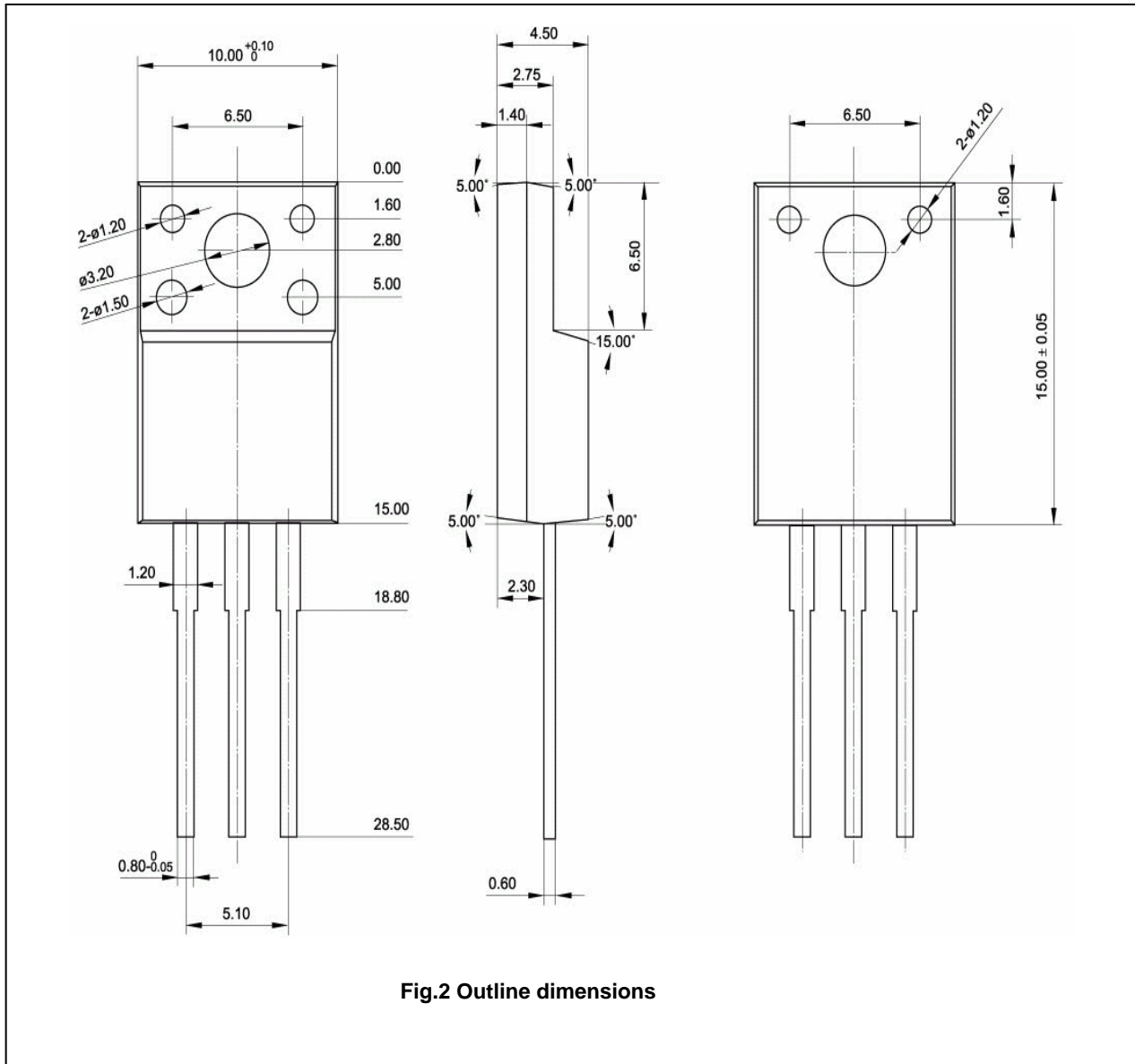

Fig.2 Outline dimensions

Silicon PNP Power Transistors

2SA1488 2SA1488A

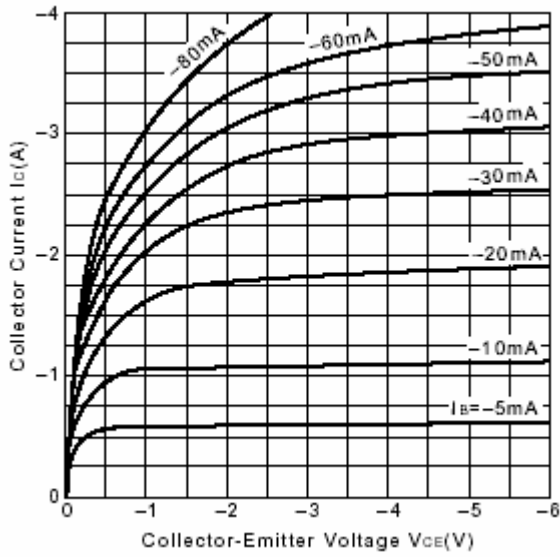

Fig.3 Static Characteristic

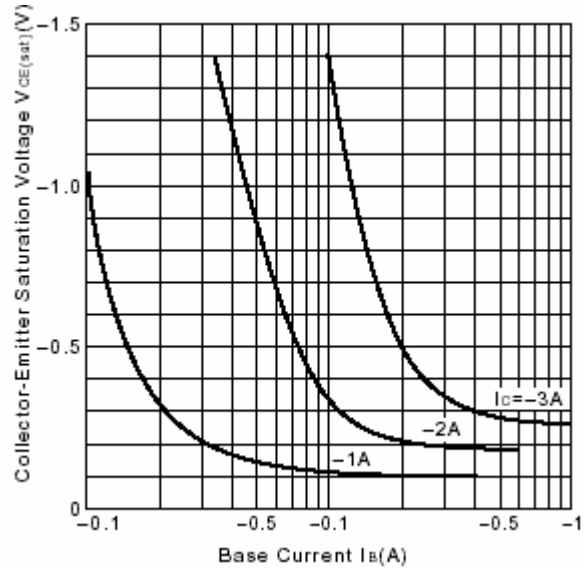

Fig.4 $V_{CE(sat)}$ - I_B Characteristics

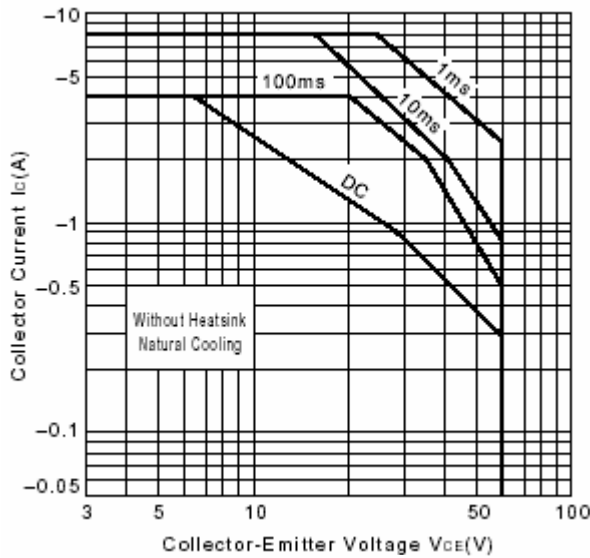

Fig.5 Safe Operating Area

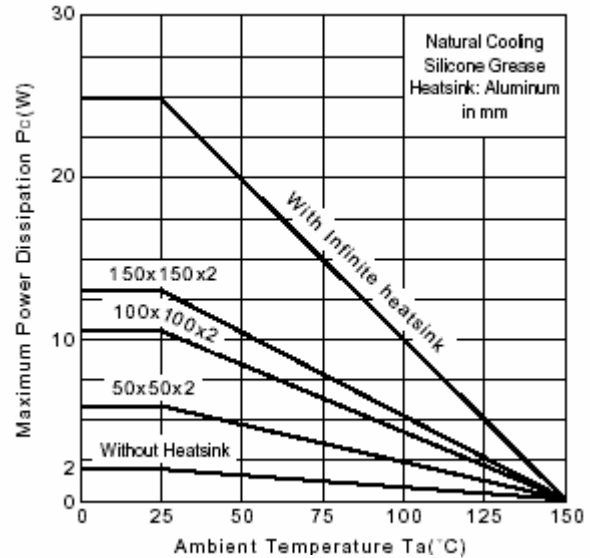

Fig.6 P_c - T_a Derating

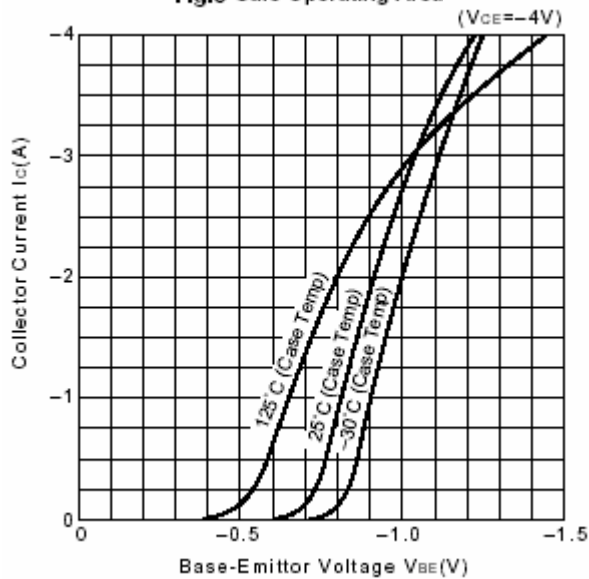

Fig.7 I_C - V_{BE}

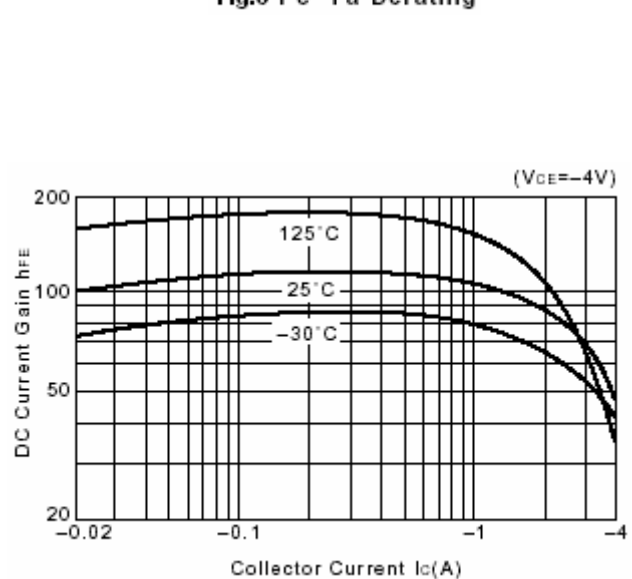

Fig.8 DC current Gain