

**DUAL 300mA LDO REGULATORS**

**AP2402**

**General Description**

The AP2402 series are dual positive voltage regulator ICs fabricated by CMOS process. Each of these ICs consists of a voltage reference, two error amplifiers, two resistor networks for setting output voltages. Each channel has a current limit circuit for current protection and a chip enable circuit with quick discharge function.

The AP2402 series feature high supply voltage ripple rejection, low dropout voltage, low noise, high output voltage accuracy, and low current consumption which make them ideal for use in various battery-powered devices. The chip-enable function allows the output of each channel to be turned on/off independently, greatly reducing the power consumption.

The AP2402 series have 2.5V/1.8V, 2.8V/1.8V and 2.8V/2.8V versions.

The AP2402 are available in SOT-23-6, TSOT-23-6 and DFN-2×2-8 packages.

**Features**

- Minimum Output Current Capability per Channel: 300mA
- High Output Voltage Accuracy:  $\pm 2\%$
- Low Quiescent Current per Channel: 50 $\mu$ A Typical
- Low Standby Current: 0.1 $\mu$ A Typical
- High PSRR: 70dB Typical (f=1kHz)
- Extremely Low Noise: 30 $\mu$ Vrms (10Hz to 100kHz)
- Operating Temperature: -40 to 85°C
- Compatible with Low ESR Ceramic Capacitor

**Applications**

- Mobile Phones, Cordless Phones
- Wireless Communication Equipment
- Portable Games
- Cameras, Video Recorders
- Sub-board Power Supplies for Telecom Equipment
- Battery Powered Equipment

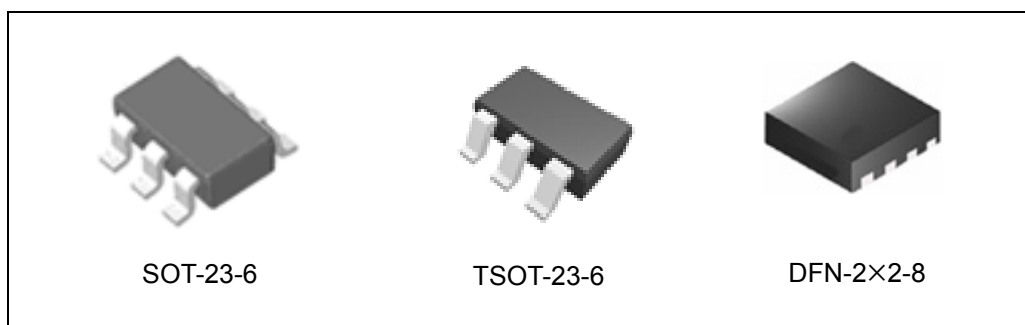

Figure 1. Package Types of AP2402

**DUAL 300mA LDO REGULATORS**
**AP2402**
**Pin Configuration**

Figure 2. Pin Configuration of AP2402 (Top View)

**Pin Description**

Pin Number		Pin Name	Function
6-pin	8-pin		
1	7	$V_{OUT2}$	Output voltage 2
2	5	GND	Ground
3	3	CE2	On/Off control 2, logic high=enable; logic low=shutdown
4	2	CE1	On/Off control 1, logic high=enable; logic low=shutdown
5	1	$V_{IN}$	Input voltage
6	8	$V_{OUT1}$	Output voltage 1
	4, 6	NC	No connection

**Functional Block Diagram**

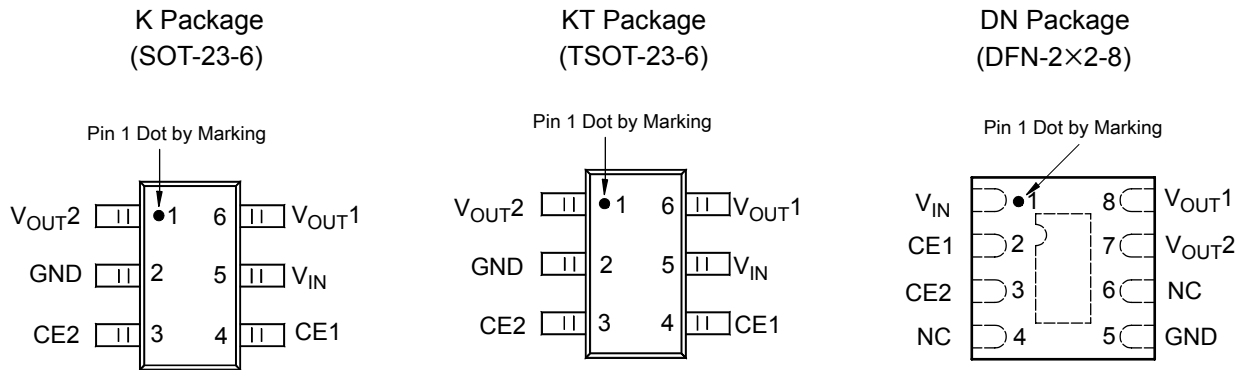
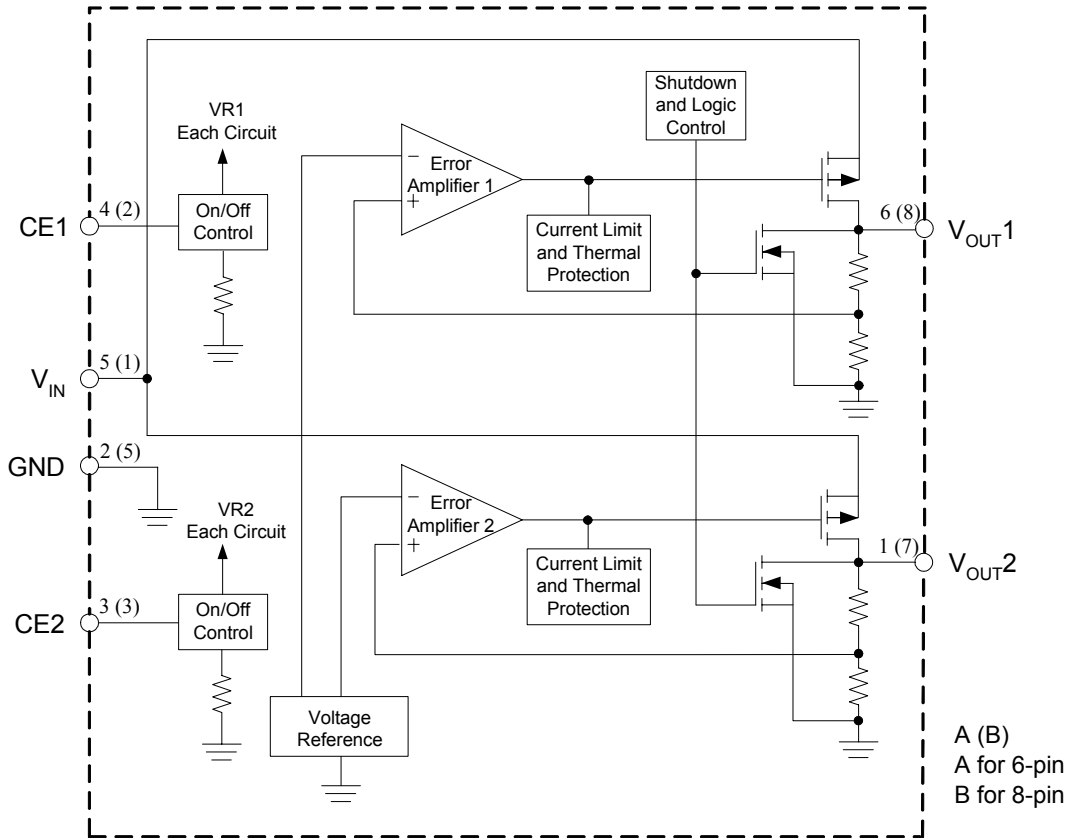

Figure 3. Functional Block Diagram of AP2402



**DUAL 300mA LDO REGULATORS**

**AP2402**

**Ordering Information**

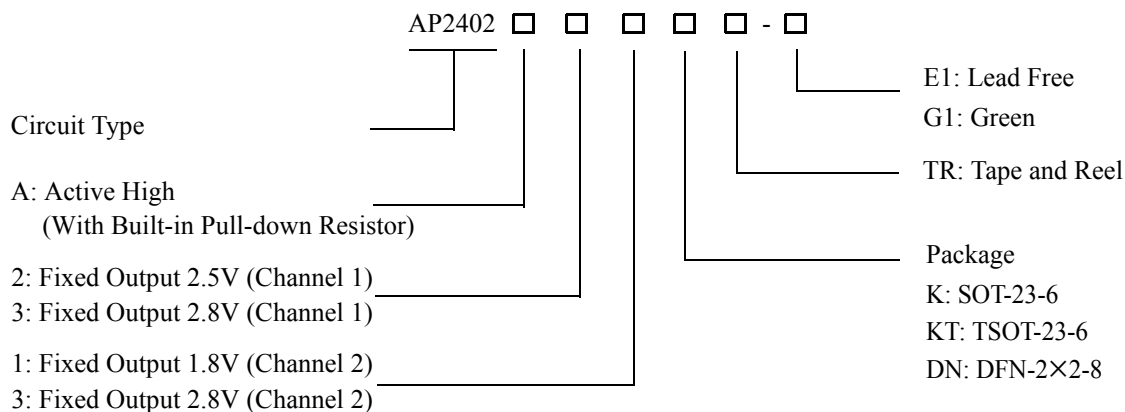

Package	Temperature Range	Output Voltages	Part Number		Marking ID		Packing Type
			Lead-Free	Green	Lead-Free	Green	
SOT-23-6	-40 to 85°C	2.5V/1.8V	AP2402A21KTR-E1	AP2402A21KTR-G1	EAA	GAA	Tape & Reel
		2.8V/1.8V	AP2402A31KTR-E1	AP2402A31KTR-G1	EAB	GAB	Tape & Reel
		2.8V/2.8V	AP2402A33KTR-E1	AP2402A33KTR-G1	EAC	GAC	Tape & Reel
TSOT-23-6	-40 to 85°C	2.5V/1.8V	AP2402A21KTTR-E1	AP2402A21KTTR-G1	S8A	L8A	Tape & Reel
		2.8V/1.8V	AP2402A31KTTR-E1	AP2402A31KTTR-G1	S8B	L8B	Tape & Reel
		2.8V/2.8V	AP2402A33KTTR-E1	AP2402A33KTTR-G1	S8C	L8C	Tape & Reel
DFN-2×2-8	-40 to 85°C	2.5V/1.8V	AP2402A21DNTR-E1	AP2402A21DNTR-G1	6A	DA	Tape & Reel
		2.8V/1.8V	AP2402A31DNTR-E1	AP2402A31DNTR-G1	6B	DB	Tape & Reel
		2.8V/2.8V	AP2402A33DNTR-E1	AP2402A33DNTR-G1	6C	DC	Tape & Reel

BCD Semiconductor's Pb-free products, as designated with "E1" suffix in the part number, are RoHS compliant. Products with "G1" suffix are available in green packages.

**DUAL 300mA LDO REGULATORS****AP2402****Absolute Maximum Ratings (Note 1)**

Parameter	Symbol	Value		Unit
Input Voltage	$V_{IN}$	6.5		V
Enable Input Voltage	$V_{CE}$	6.5		V
Output Current ( $T_A=25^\circ\text{C}$ )	$I_{OUT1}+I_{OUT2}$	700		mA
Power Dissipation ( $T_A=25^\circ\text{C}$ )	$P_D$	SOT-23-6	250	mW
Junction Temperature	$T_J$	150		$^\circ\text{C}$
Storage Temperature Range	$T_{STG}$	-65 to 150		$^\circ\text{C}$
Lead Temperature (Soldering, 10sec)	$T_{LEAD}$	260		$^\circ\text{C}$
ESD (Human Body Model)	ESD	6000		V
ESD (Machine Model)	ESD	200		V

Note 1: Stresses greater than those listed under "Absolute Maximum Ratings" may cause permanent damage to the device. These are stress ratings only, and functional operation of the device at these or any other conditions beyond those indicated under "Recommended Operating Conditions" is not implied. Exposure to "Absolute Maximum Ratings" for extended periods may affect device reliability.

**Recommended Operating Conditions**

Parameter	Symbol	Min	Max	Unit
Input Voltage	$V_{IN}$		6	V
Operating Ambient Temperature Range	$T_A$	-40	85	$^\circ\text{C}$



**DUAL 300mA LDO REGULATORS**

**AP2402**

**Electrical Characteristics**

(Channel 1/Channel 2:  $V_{IN}=V_{OUT}+1V$ ,  $T_A=25^{\circ}C$ ,  $C_{IN}=1\mu F$ ,  $C_{OUT}=1\mu F$ , unless otherwise specified.)

Parameter	Symbol	Conditions	Min	Typ	Max	Unit	
Output Voltage Accuracy	$\Delta V_{OUT}/V_{OUT}$	Variation from specified $V_{OUT}$ , $I_{OUT}=30mA$	-2		2	%	
Input Voltage	$V_{IN}$				6	V	
Maximum Output Current	$I_{OUT(Max)}$		300			mA	
Load Regulation	$V_{RLOAD}$	$1mA \leq I_{OUT} \leq 300mA$		10	60	mV	
Line Regulation	$V_{RLINE}$	$V_{OUT}+1V \leq V_{IN} \leq 6V$ $I_{OUT}=30mA$ , $V_{CE}=V_{IN}$		0.01	0.2	%/V	
Dropout Voltage	$V_{DROP}$	$I_{OUT}=30mA$	$V_{OUT}=1.8V$		30	36	mV
			$V_{OUT}=2.5V$		20	24	
			$V_{OUT}=2.8V$		20	24	
		$I_{OUT}=100mA$	$V_{OUT}=1.8V$		100	120	
			$V_{OUT}=2.5V$		65	80	
			$V_{OUT}=2.8V$		65	80	
Quiescent Current	$I_Q$	$I_{OUT}=0mA$		50	90	$\mu A$	
Standby Current	$I_{STD}$	$V_{CE}$ in OFF mode		0.1	1	$\mu A$	
Power Supply Rejection Ratio	PSRR	Ripple 0.5Vp-p, $f=1kHz$ $V_{IN}=V_{OUT}+1V$ , $I_{OUT}=30mA$		70		dB	
Output Voltage Temperature Coefficient	$(\Delta V_{OUT}/V_{OUT})/\Delta T$	$I_{OUT}=30mA$ , $-40^{\circ}C \leq T_A \leq 85^{\circ}C$		$\pm 100$		ppm/ $^{\circ}C$	
Current Limit	$I_{LIMIT}$	$V_{CE}=V_{IN}$		400		mA	
Short Circuit Current	$I_{SHORT}$	$V_{CE}=V_{IN}$ , $V_{OUT}$ short to GND		50		mA	
RMS Output Noise	$V_{NOISE}$	$10Hz \leq f \leq 100kHz$		30		$\mu V_{rms}$	
CE "High" Voltage		CE input voltage "High"	1.3		6	V	
CE "Low" Voltage		CE input voltage "Low"			0.4	V	
Thermal Shutdown				165		$^{\circ}C$	
Thermal Shutdown Hysteresis				30		$^{\circ}C$	



Typical Performance Characteristics

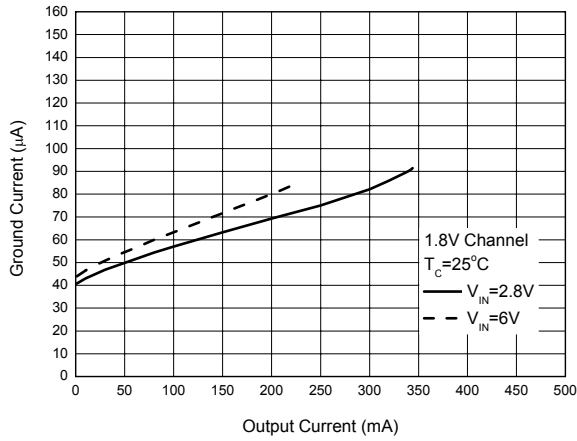

Figure 4. Ground Current vs. Output Current

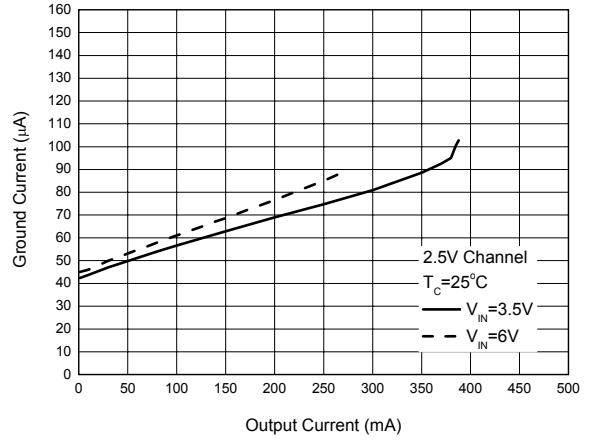

Figure 5. Ground Current vs. Output Current

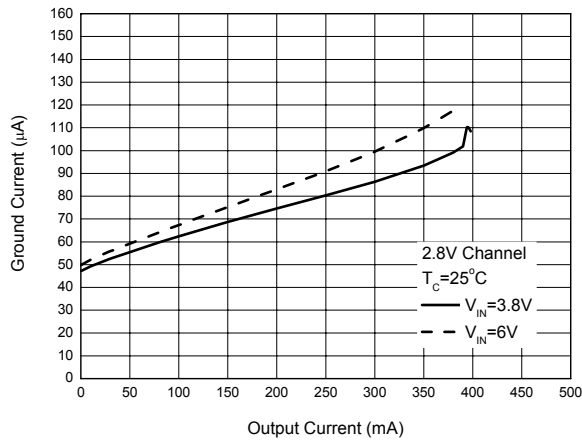

Figure 6. Ground Current vs. Output Current

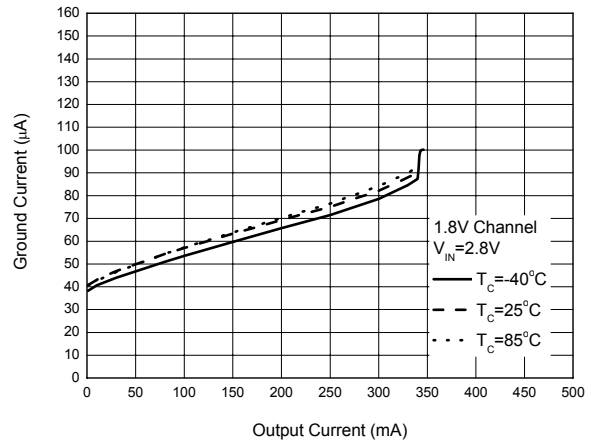

Figure 7. Ground Current vs. Output Current



Typical Performance Characteristics (Continued)

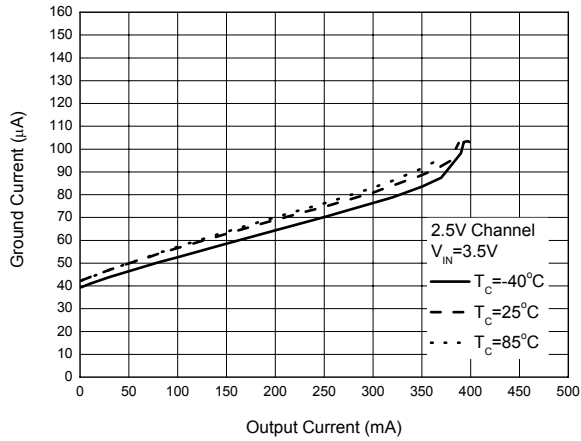

Figure 8. Ground Current vs. Output Current

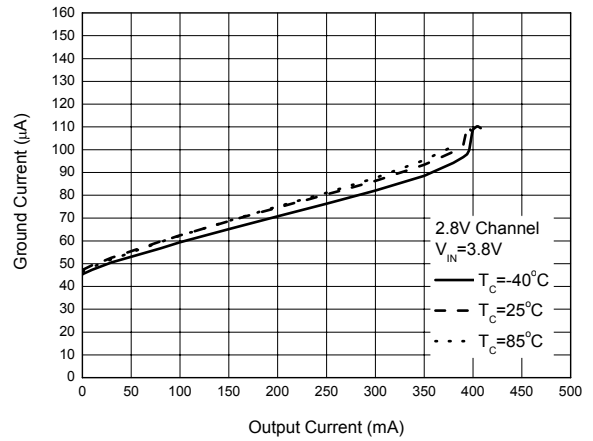

Figure 9. Ground Current vs. Output Current

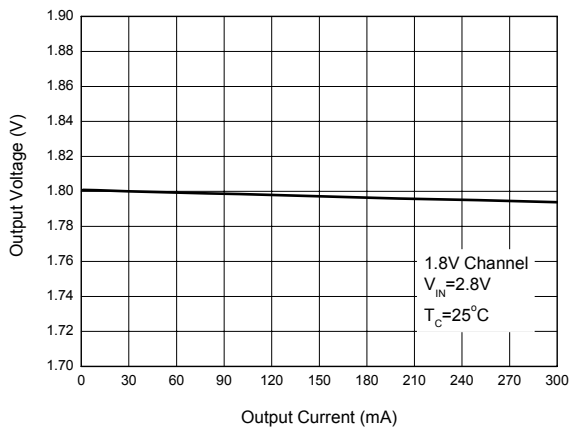

Figure 10. Output Voltage vs. Output Current

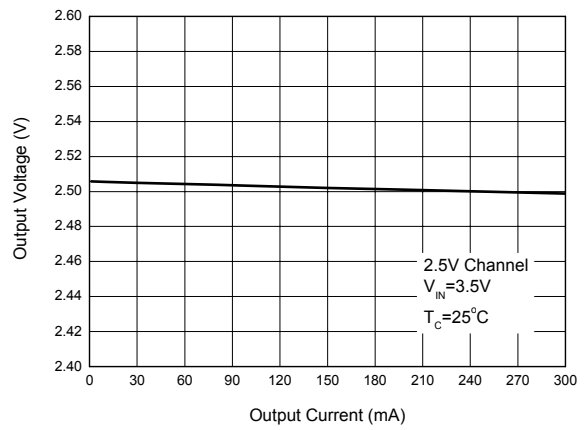

Figure 11. Output Voltage vs. Output Current





Typical Performance Characteristics (Continued)

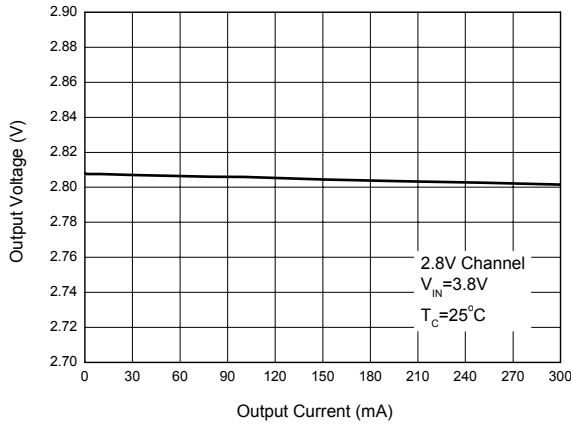

Figure 12. Output Voltage vs. Output Current

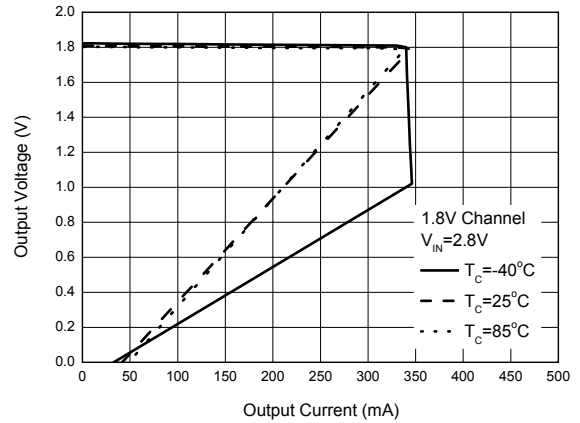

Figure 13. Output Voltage vs. Output Current

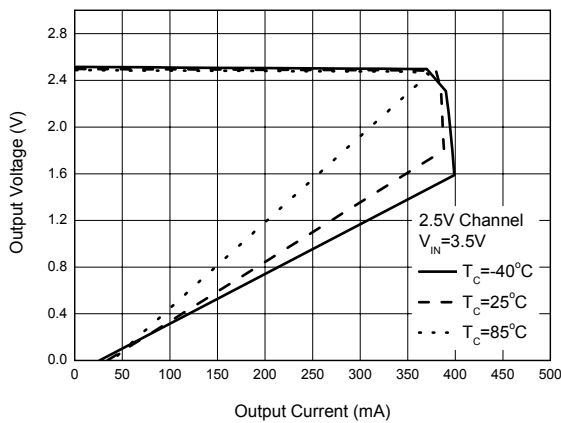

Figure 14. Output Voltage vs. Output Current

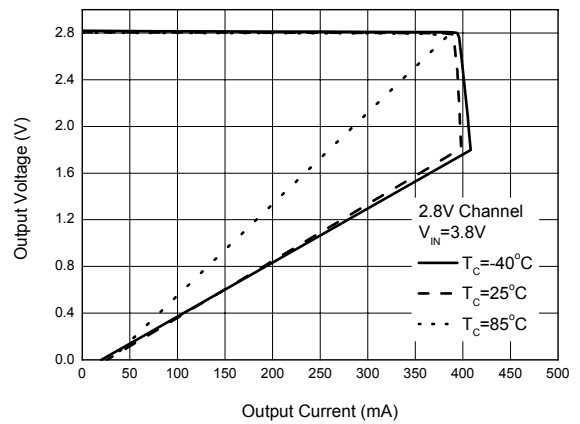

Figure 15. Output Voltage vs. Output Current



DUAL 300mA LDO REGULATORS

AP2402

Typical Performance Characteristics (Continued)

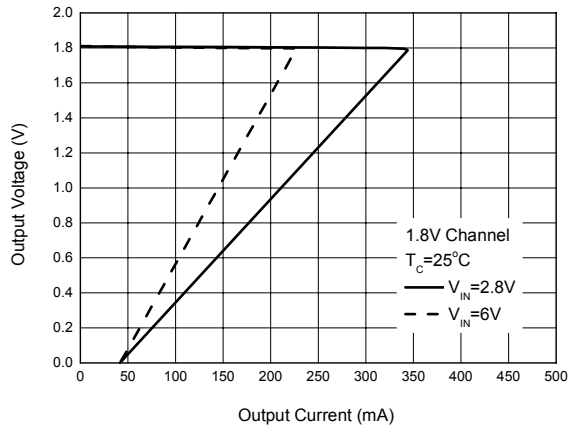

Figure 16. Output Voltage vs. Output Current

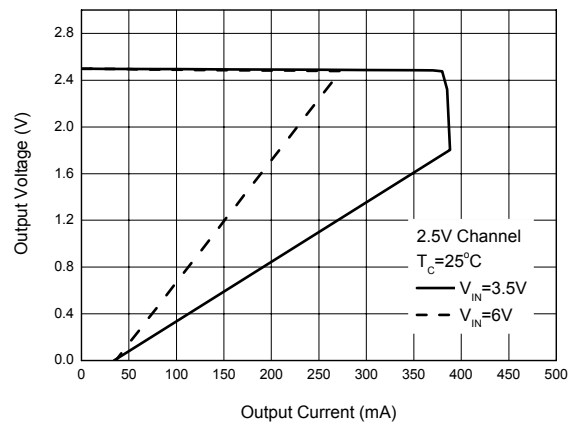

Figure 17. Output Voltage vs. Output Current

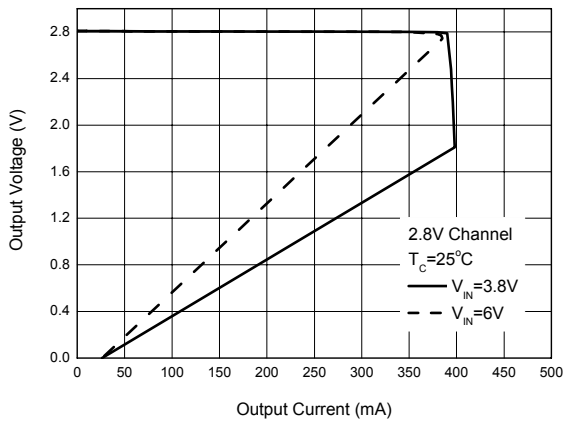

Figure 18. Output Voltage vs. Output Current

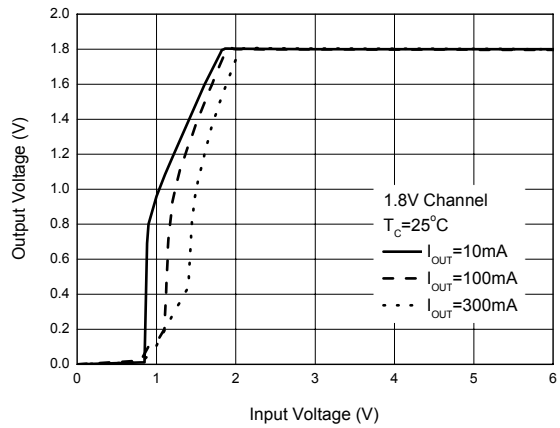

Figure 19. Output Voltage vs. Input Voltage



Typical Performance Characteristics (Continued)

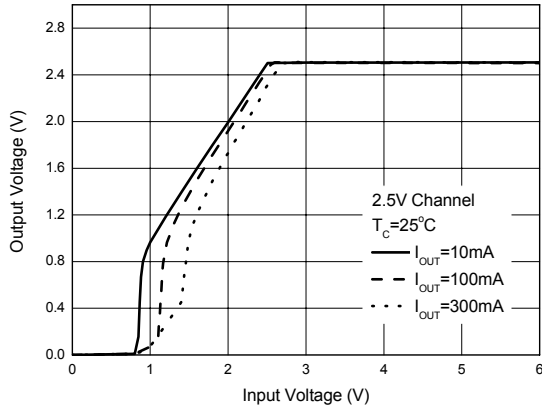

Figure 20. Output Voltage vs. Input Voltage

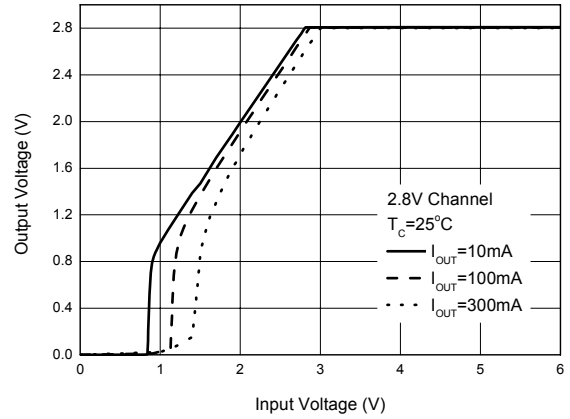

Figure 21. Output Voltage vs. Input Voltage

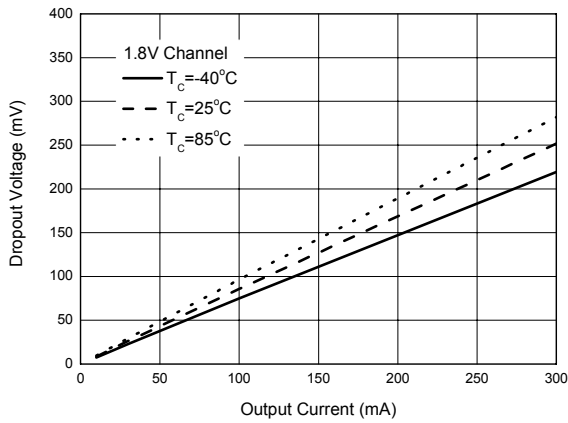

Figure 22. Dropout Voltage vs. Output Current

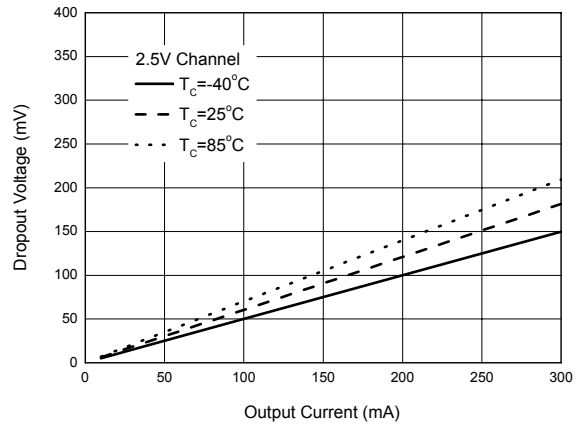

Figure 23. Dropout Voltage vs. Output Current



Typical Performance Characteristics (Continued)

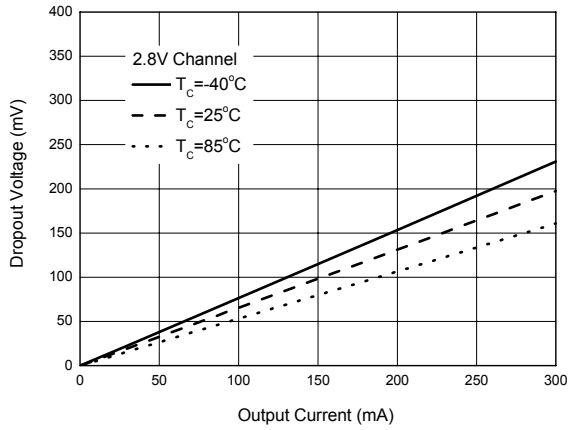

Figure 24. Dropout Voltage vs. Output Current

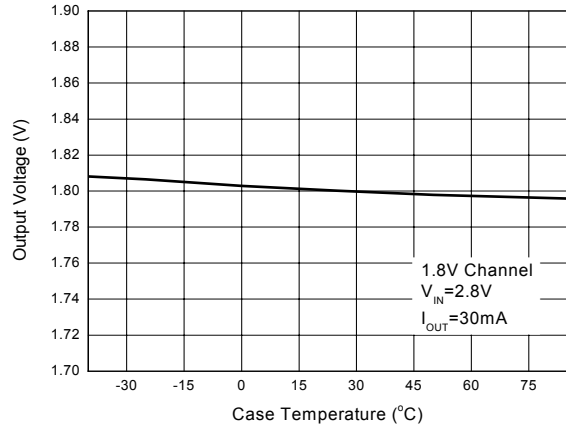

Figure 25. Output Voltage vs. Case Temperature

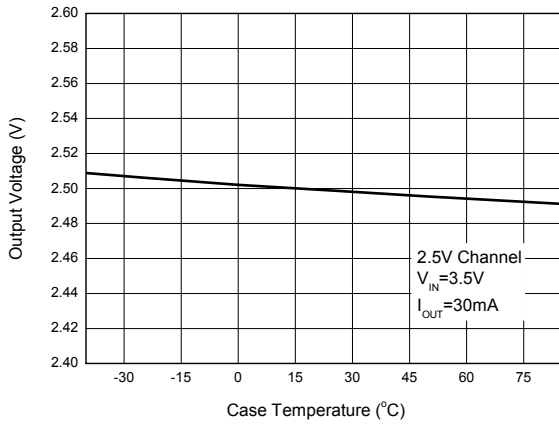

Figure 26. Output Voltage vs. Case Temperature

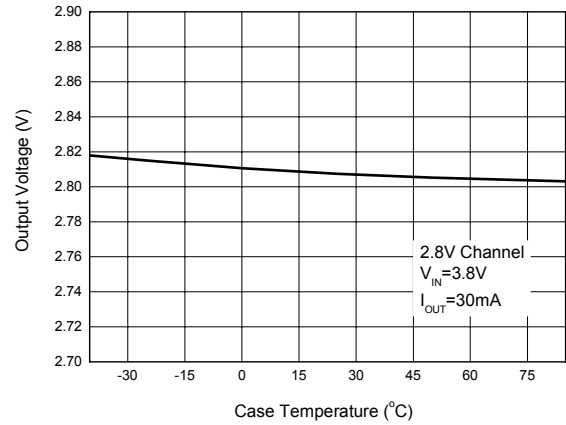

Figure 27. Output Voltage vs. Case Temperature



Typical Performance Characteristics (Continued)

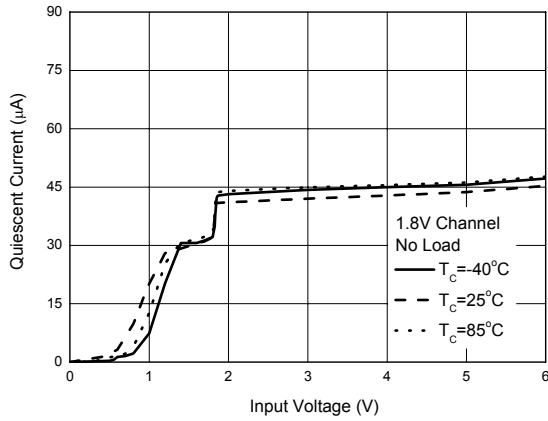

Figure 28. Quiescent Current vs. Input Voltage

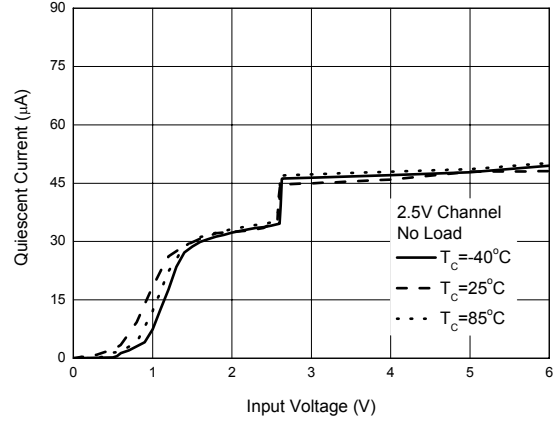

Figure 29. Quiescent Current vs. Input Voltage

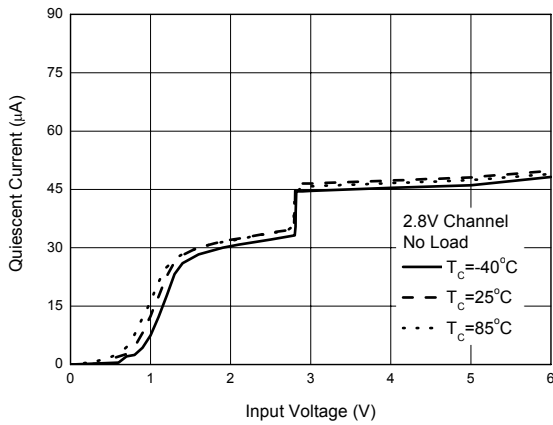

Figure 30. Quiescent Current vs. Input Voltage

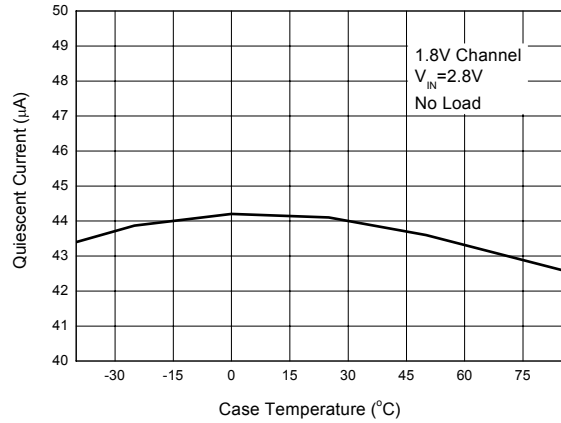

Figure 31. Quiescent Current vs. Case Temperature



**DUAL 300mA LDO REGULATORS**

**AP2402**

**Typical Performance Characteristics (Continued)**

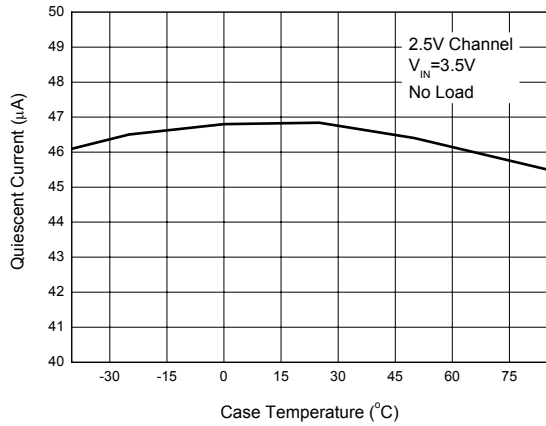

Figure 32. Quiescent Current vs. Case Temperature

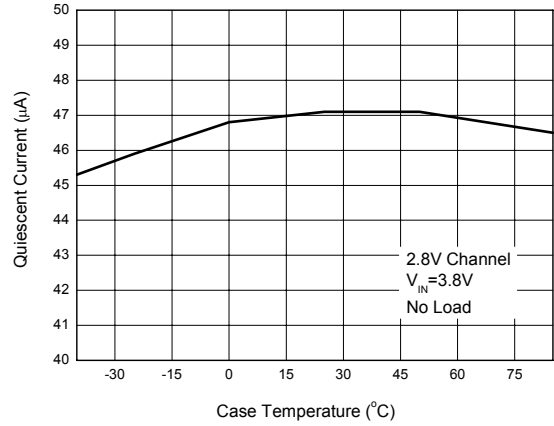

Figure 33. Quiescent Current vs. Case Temperature

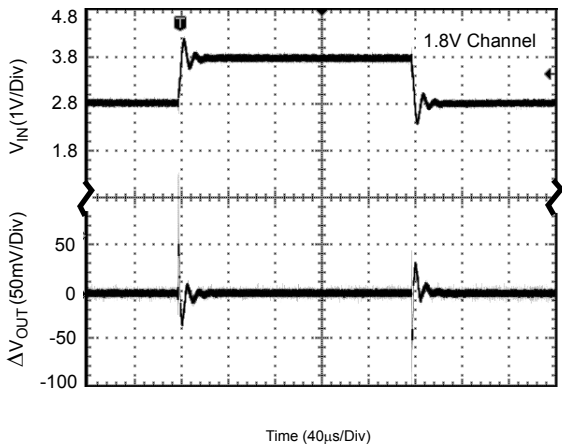

Figure 34. Line Transient  
(Conditions:  $I_{OUT}=50\text{mA}$ ,  $C_{IN}=0.68\mu\text{F}$ ,  $C_{OUT}=1\mu\text{F}$ )

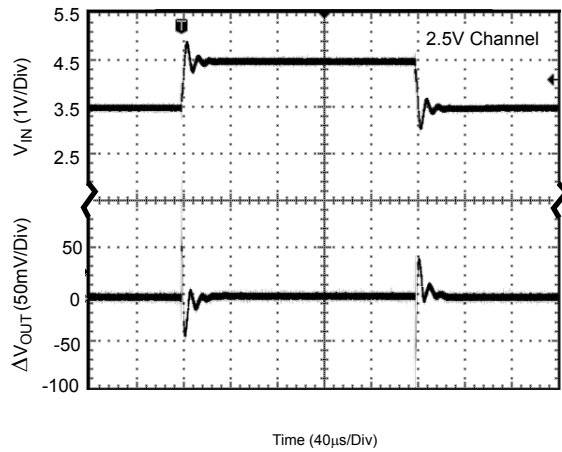

Figure 35. Line Transient  
(Conditions:  $I_{OUT}=50\text{mA}$ ,  $C_{IN}=0.68\mu\text{F}$ ,  $C_{OUT}=1\mu\text{F}$ )



DUAL 300mA LDO REGULATORS

AP2402

Typical Performance Characteristics (Continued)

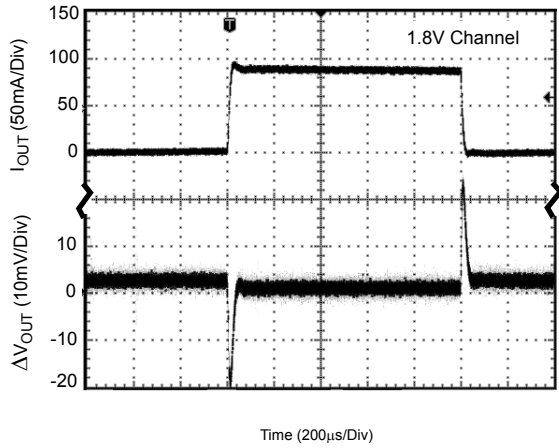

Figure 36. Load Transient

(Conditions:  $V_{IN}=2.8V$ ,  $I_{OUT}=10$  to  $100mA$ ,  $C_{IN}=C_{OUT}=1\mu F$ )

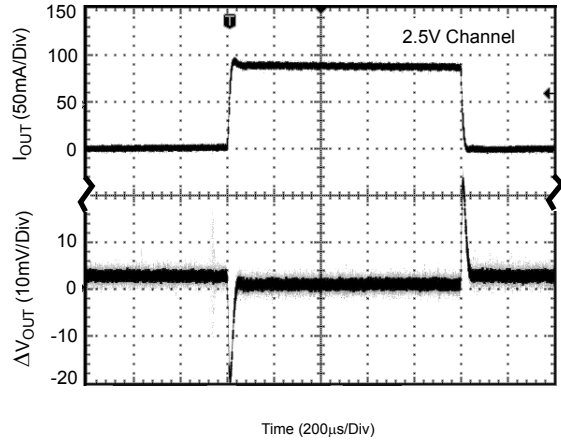

Figure 37. Load Transient

(Conditions:  $V_{IN}=3.5V$ ,  $I_{OUT}=10$  to  $100mA$ ,  $C_{IN}=C_{OUT}=1\mu F$ )

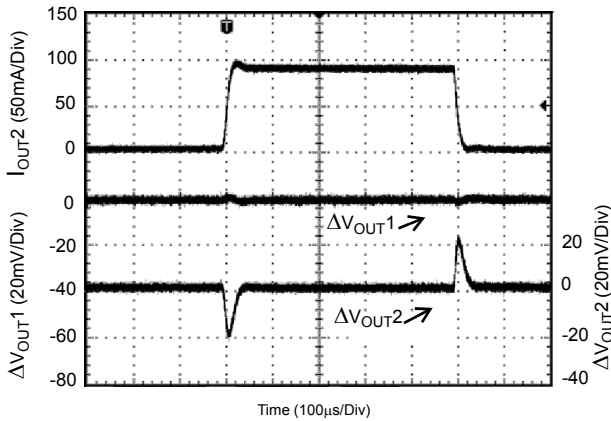

Figure 38. Cross Talk 1

(Conditions: channel 1 and 2 on,  $I_{OUT1}=30mA$ ,  $I_{OUT2}=10$  to  $100mA$ ,  $C_{IN}=C_{OUT}=1\mu F$ )

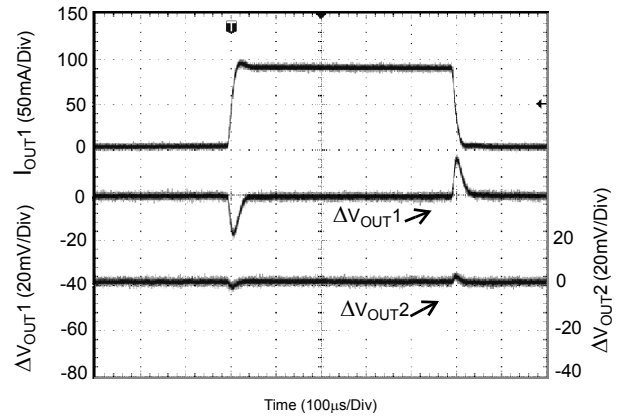

Figure 39. Cross Talk 2

(Conditions: channel 1 and 2 on,  $I_{OUT1}=10$  to  $100mA$ ,  $I_{OUT2}=30mA$ ,  $C_{IN}=C_{OUT}=1\mu F$ )



Typical Performance Characteristics (Continued)

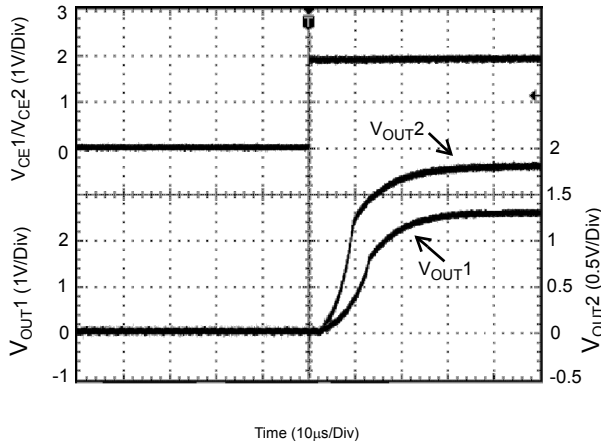

Figure 40. Enable Voltage vs. Output Voltage  
(Conditions:  $V_{CE1}=V_{CE2}=0$  to 2V,  $I_{OUT}=0$ mA,  $C_{IN}=C_{OUT}=1\mu$ F)

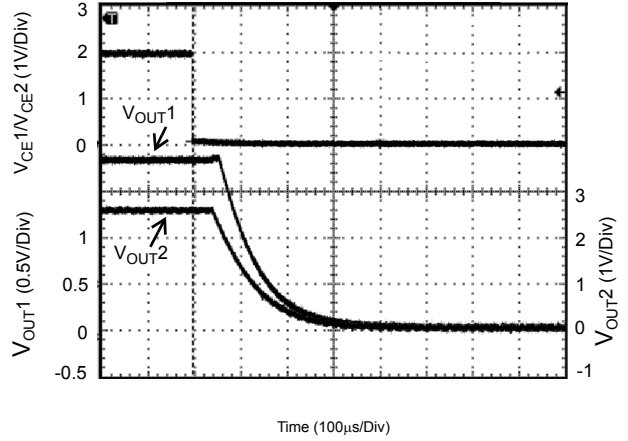

Figure 41. Auto Discharge Function  
(Conditions:  $V_{CE1}=V_{CE2}=0$  to 2V,  $I_{OUT}=0$ mA,  $C_{IN}=C_{OUT}=1\mu$ F)

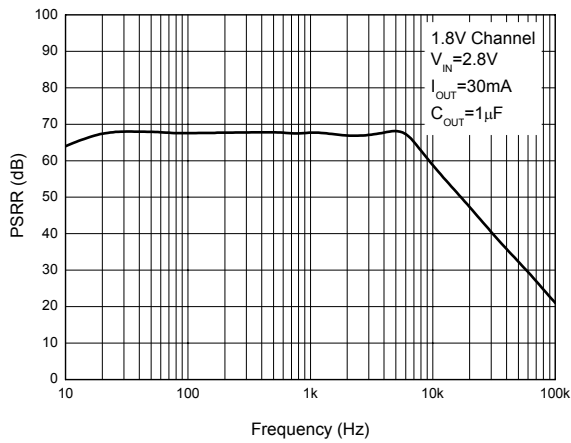

Figure 42. PSRR vs. Frequency

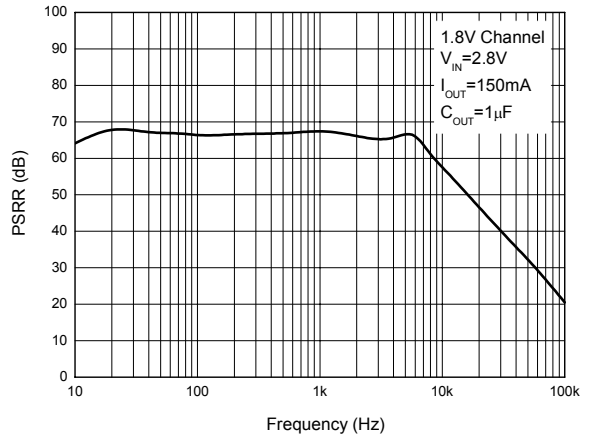

Figure 43. PSRR vs. Frequency





Typical Performance Characteristics (Continued)

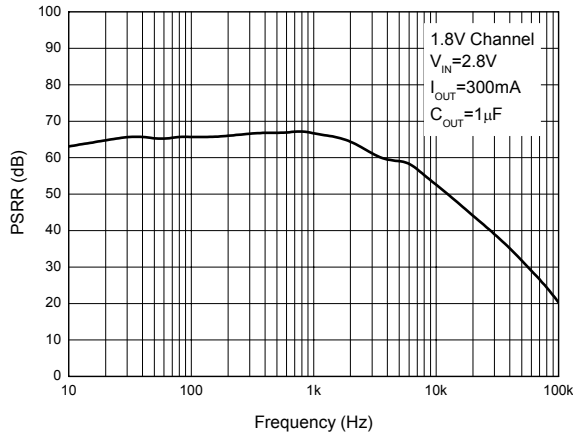

Figure 44. PSRR vs. Frequency

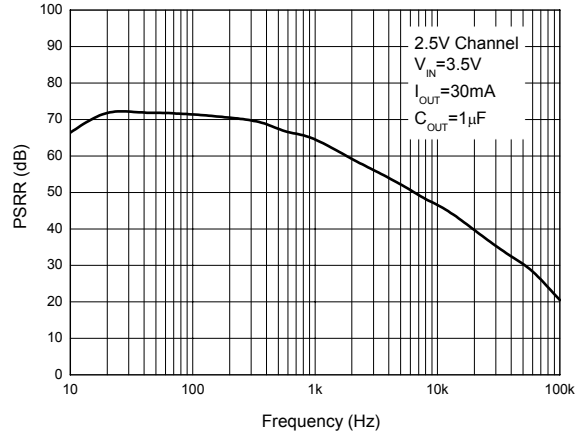

Figure 45. PSRR vs. Frequency

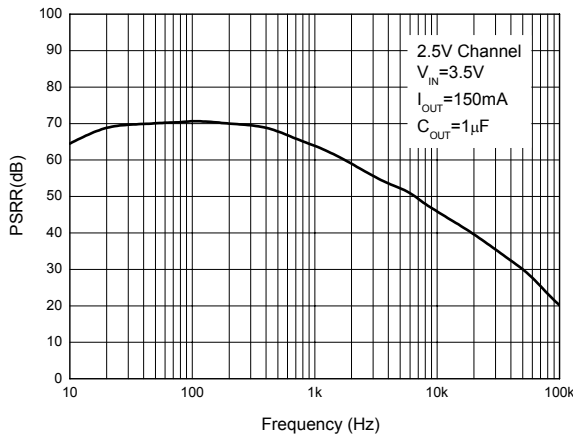

Figure 46. PSRR vs. Frequency

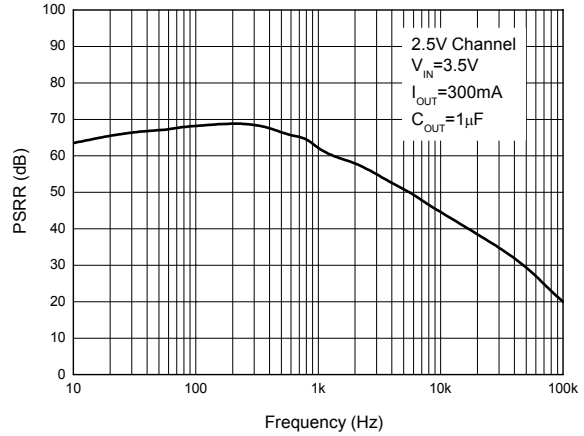

Figure 47. PSRR vs. Frequency



Typical Performance Characteristics (Continued)

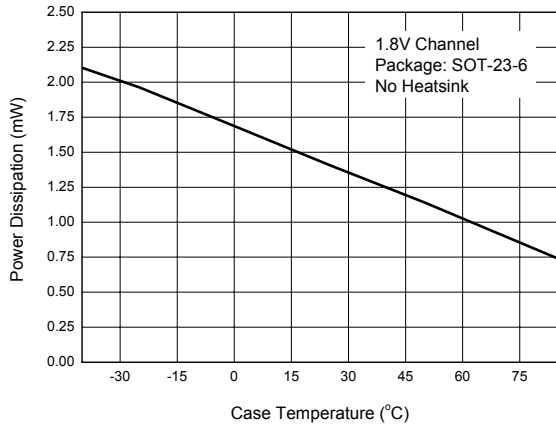

Figure 48. Power Dissipation vs. Case Temperature

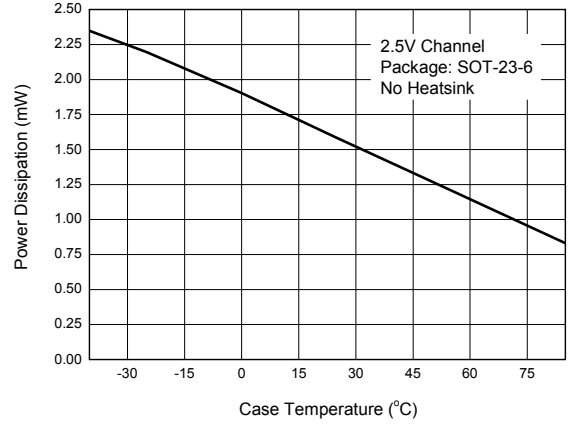

Figure 49. Power Dissipation vs. Case Temperature

**Typical Application**

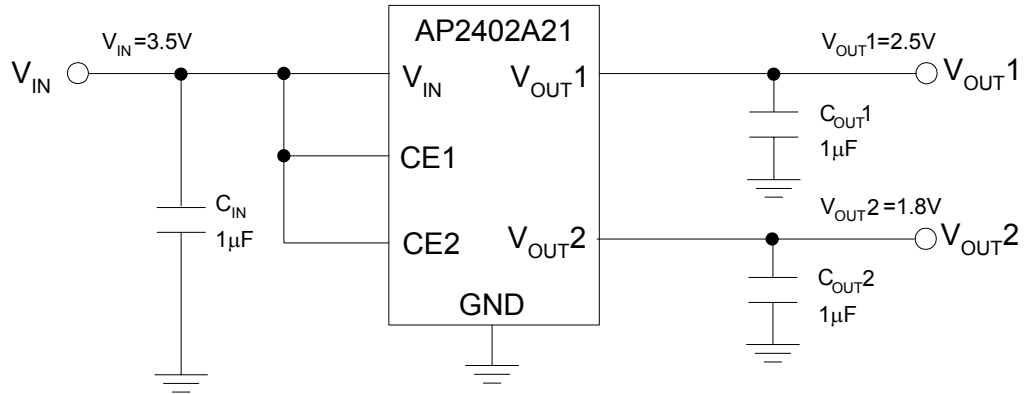

Figure 50. Typical Application of AP2402



DUAL 300mA LDO REGULATORS

AP2402

Mechanical Dimensions

SOT-23-6

Unit: mm(inch)

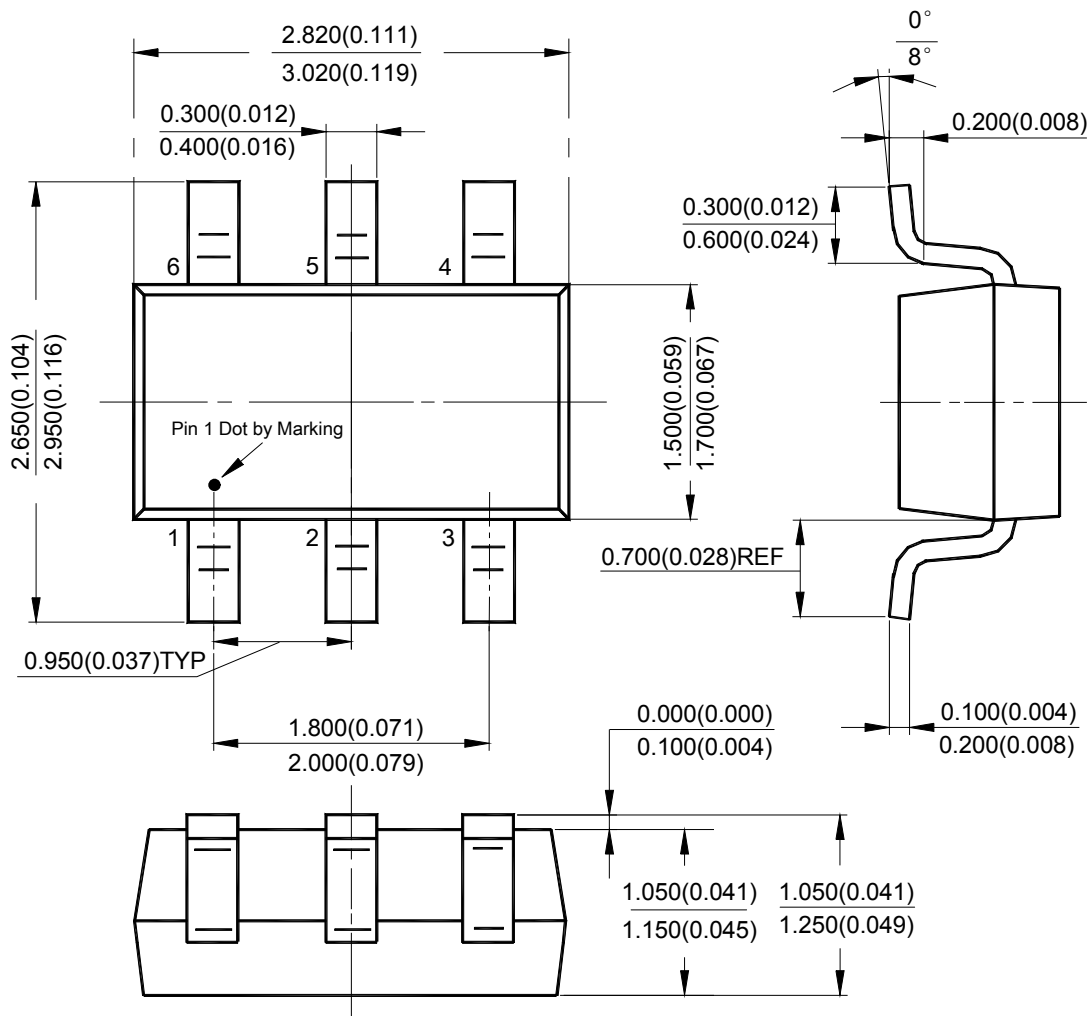



DUAL 300mA LDO REGULATORS

AP2402

Mechanical Dimensions (Continued)

TSOT-23-6

Unit: mm(inch)

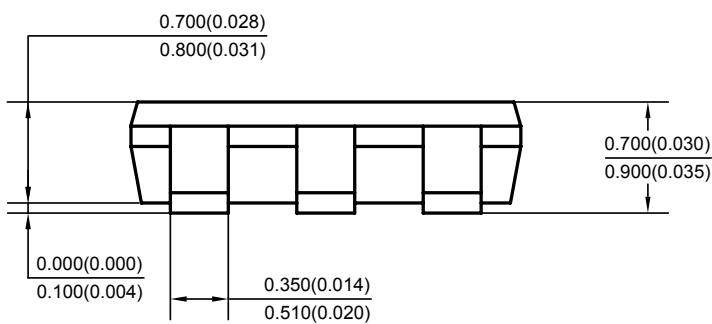
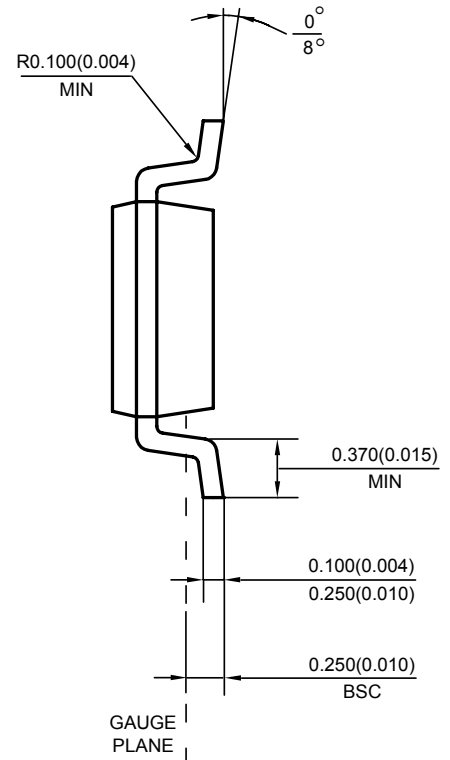
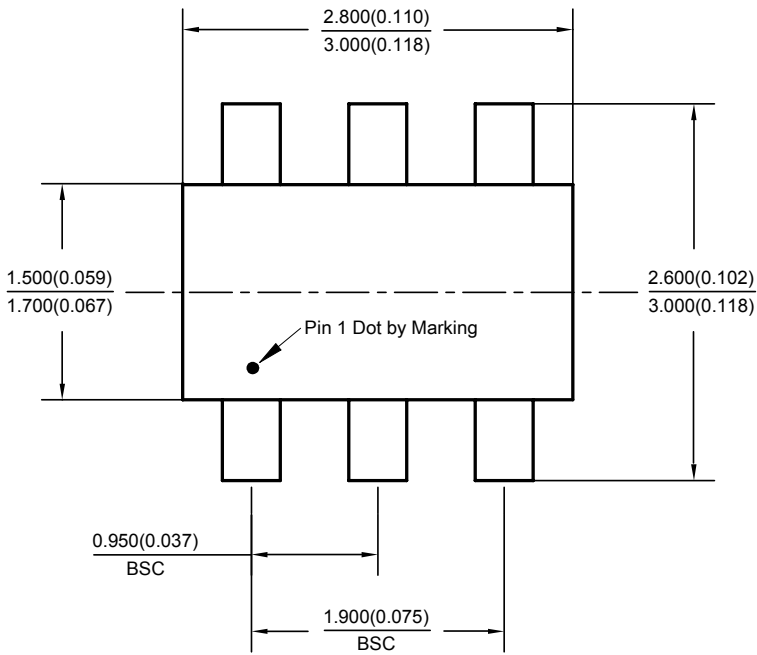



**DUAL 300mA LDO REGULATORS**

**AP2402**

**Mechanical Dimensions (Continued)**

**DFN-2x2-8**

**Unit: mm(inch)**

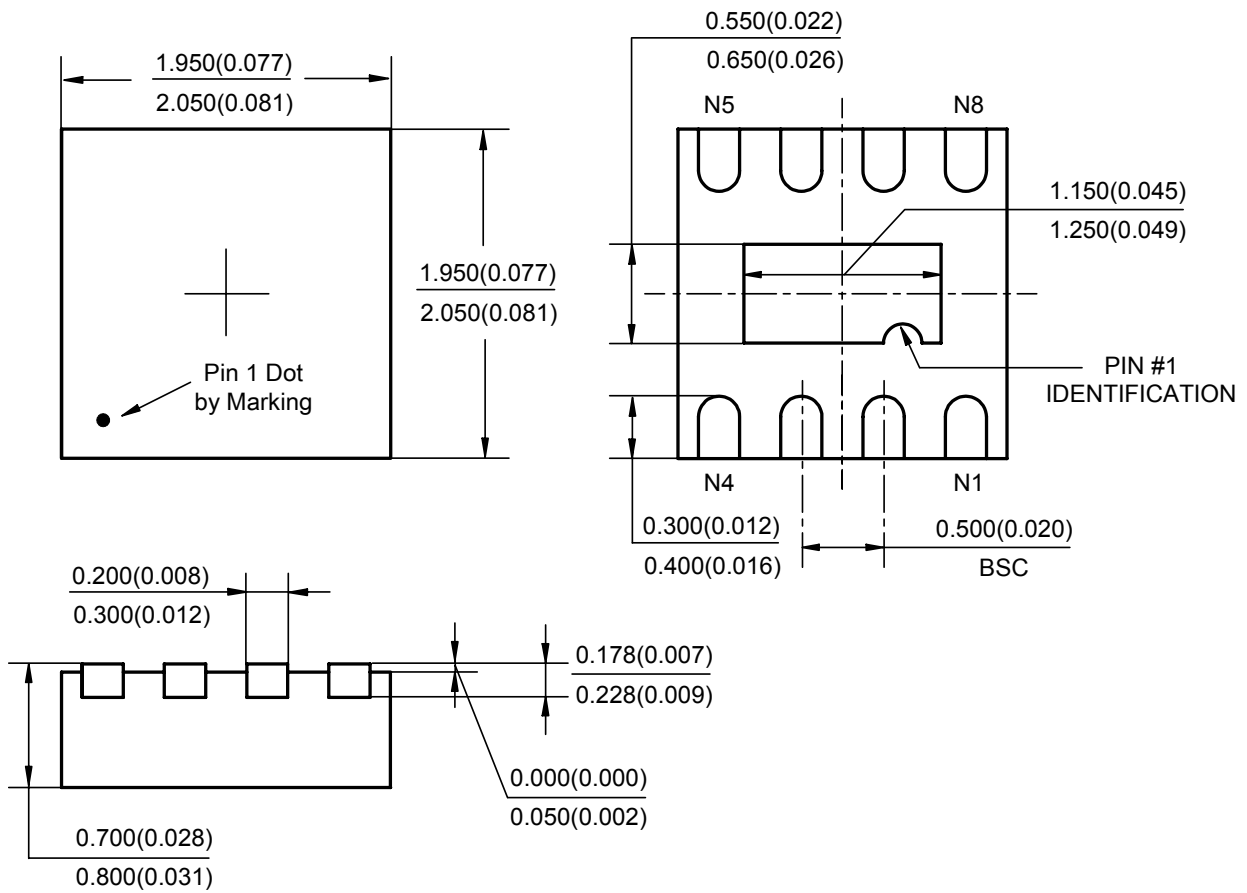



## **BCD Semiconductor Manufacturing Limited**

<http://www.bcdsemi.com>

### **IMPORTANT NOTICE**

BCD Semiconductor Manufacturing Limited reserves the right to make changes without further notice to any products or specifications herein. BCD Semiconductor Manufacturing Limited does not assume any responsibility for use of any its products for any particular purpose, nor does BCD Semiconductor Manufacturing Limited assume any liability arising out of the application or use of any its products or circuits. BCD Semiconductor Manufacturing Limited does not convey any license under its patent rights or other rights nor the rights of others.

---

#### **MAIN SITE**

##### **- Headquarters**

##### **BCD Semiconductor Manufacturing Limited**

No. 1600, Zi Xing Road, Shanghai Zizhu Science-based Industrial Park, 200241, China  
Tel: +86-21-24162266, Fax: +86-21-24162277

##### **- Wafer Fab**

##### **Shanghai SIM-BCD Semiconductor Manufacturing Co., Ltd.**

800 Yi Shan Road, Shanghai 200233, China  
Tel: +86-21-6485 1491, Fax: +86-21-5450 0008

#### **REGIONAL SALES OFFICE**

##### **Shenzhen Office**

**Shanghai SIM-BCD Semiconductor Manufacturing Co., Ltd., Shenzhen Office**  
Room E, 5F, Noble Center, No.1006, 3rd Fuzhong Road, Futian District, Shenzhen,  
518026, China  
Tel: +86-755-8826 7951  
Fax: +86-755-8826 7865

##### **Taiwan Office**

**BCD Semiconductor (Taiwan) Company Limited**  
4F, 298-1, Rui Guang Road, Nei-Hu District, Taipei,  
Taiwan  
Tel: +886-2-2656 2808  
Fax: +886-2-2656 2806

##### **USA Office**

**BCD Semiconductor Corp.**  
30920 Huntwood Ave. Hayward,  
CA 94544, USA  
Tel : +1-510-324-2988  
Fax: +1-510-324-2788