

Specifications

Parameter	Unit	Minimum	Typical	Maximum
Center Frequency	MHz	78.9	79	79.1
Insertion Loss	dB	-	30.5	31.5
1 dB Bandwidth	MHz	3.85	3.86	-
3 dB Bandwidth	MHz	-	4.03	-
35 dB Bandwidth	MHz	-	4.63	4.7
40 dB Bandwidth	MHz	-	4.67	-
45 dB Bandwidth	MHz	-	4.7	5
50 dB Bandwidth	MHz	-	4.72	5.8
55 dB Bandwidth	MHz	-	4.75	13.8
Passband Variation	dB	-	0.7	1.0
Absolute Delay	usec	-	4.1	4.5
Ultimate Rejection($f_0 \pm 15\text{MHz}$)	dB	60	62	-
Material Temperature coefficient	KHz/°C	0.08		
Ambient Temperature	°C	25		
Package Size	DIP3512 (35.0x12.8x4.7mm3)			

Notes:

1. All specifications are based on the test circuit shown
2. In production, devices will be tested at room temperature to a guardbanded specification to ensure electrical compliance over temperature
3. Electrical margin has been built into the design to account for the variations due to temperature drift and manufacturing tolerances
4. This is the optimum impedance in order to achieve the performance show

Matching Configuration

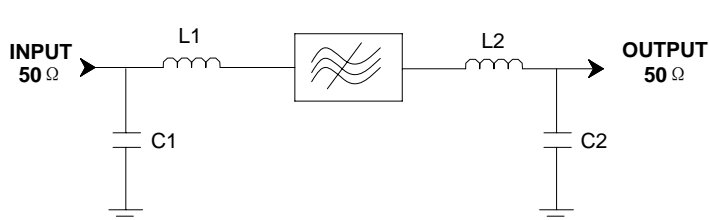

L1=L2=270nH
C1=22pF C2=36pF
Source/Load Impedance=50 ohm

Notes - Component values may change depending on board layout.



SIPAT Co., Ltd.
(CETC No. 26 Research Institute)
Nanping Huayuan Road No. 14
Chongqing, China, 400060

Part Number	LBS07903		
Rev. Date	2007-3-14		
Ver.	1.0	Page 1/4	

Package Dimension

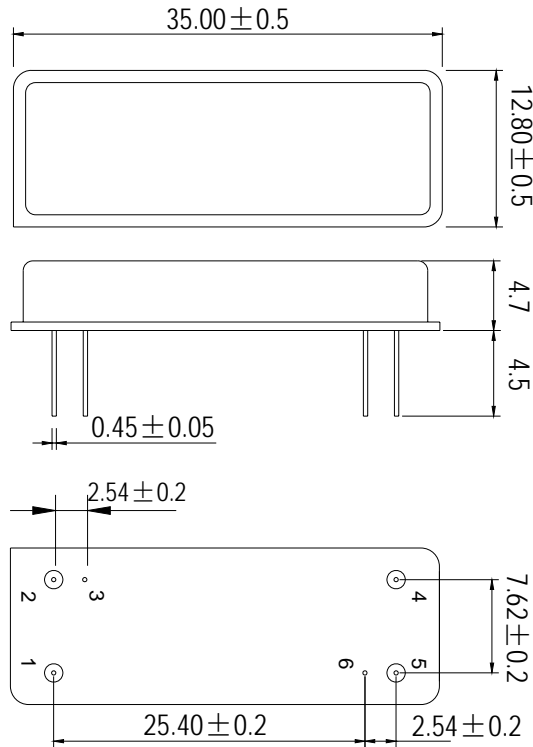

Input	1
Output	5
Ground	2,3,4,6

Package: DIP3512

Unit: mm



SIPAT Co., Ltd.
(CETC No. 26 Research Institute)
Nanping Huayuan Road No. 14
Chongqing, China, 400060

Part Number	LBS07903	
Rev. Date	2007-3-14	
Ver.	1.0	Page 2/4

Typical Performance

Frequency Response

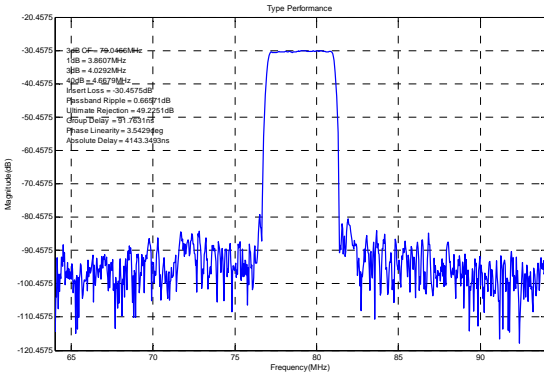

Horizontal: 5MHz/Div Vertical: 10dB/Div

Passband Response

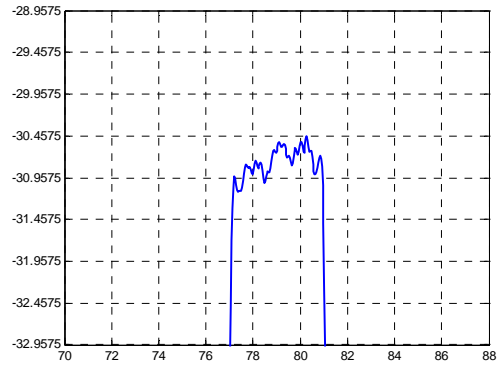

Horizontal: 2MHz/Div Vertical: 0.5dB/Div

Group Delay Variation(f0±1.88MHz)

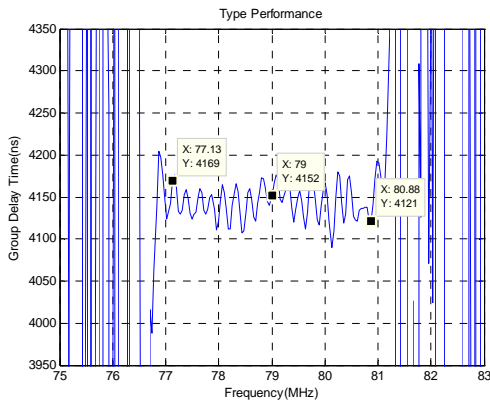

Horizontal: 1MHz/Div Vertical: 50ns/Div

Phase Linearity(f0±1.88MHz)

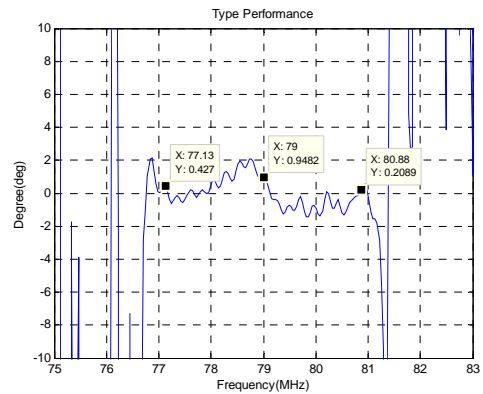

Horizontal: 1MHz/Div Vertical: 2deg/Div

Smith Chart S11

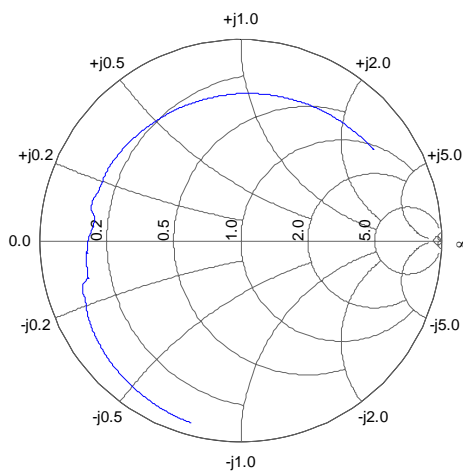

Smith Chart S22

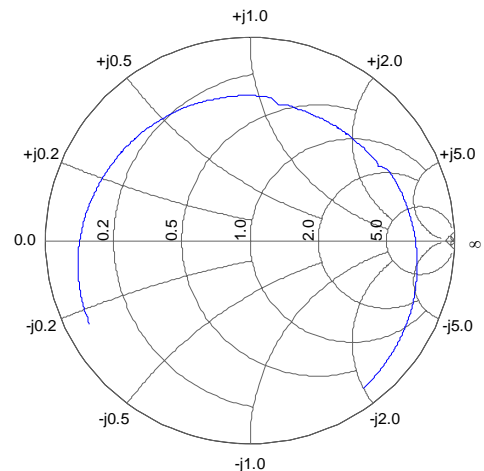

SIPAT Co., Ltd.
(CETC No. 26 Research Institute)
Nanping Huayuan Road No. 14
Chongqing, China, 400060

Part Number	LBS07903	
Rev. Date	2007-3-14	
Ver.	1.0	Page 3/4

Maximum Ratings

Operating Temperature Range	°C	[-40°C;+85°C]
Storage Temperature Range	°C	[-40°C;+105°C]
DC Voltage	V	0
Input Power	dBm	10 max
ESD Class		1



SIPAT Co., Ltd.
(CETC No. 26 Research Institute)
Nanping Huayuan Road No. 14
Chongqing, China, 400060

Part Number	LBS07903		
Rev. Date	2007-3-14		
Ver.	1.0	Page	4/4