



**1.2V/1.32V 0.4A Low Dropout Fixed-Mode Regulator**

**■ Features**

- 1.2V maximum dropout at full load current
- Fast transient response
- Output current limiting
- Built-in thermal shutdown
- Needs Only 1uF Capacitor for stability
- Good noise rejection
- 3-Terminal Fixed 1.2V/1.32V
- Low ESR Ceramic Capacitor for output stability
- Packages : SOT23
- RoHS Compliant

**■ Applications**

- PC peripheral
- Communication
- LCD Modules

**■ Ordering Information**

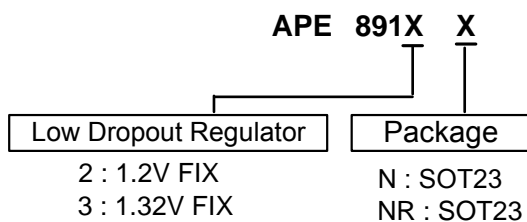

**■ General Description**

APE891X is a low dropout fixed-mode regulator with minimum of 0.4A output current capability. The product is specifically designed to provide well-regulated supply for low voltage IC applications such as high-speed bus termination and low current 1.2V/1.32V logic supply.

APE891X is guaranteed to have lower than 1.2V dropout at full load current making it ideal to provide well-regulated outputs of 1.2V/1.32V with 2.4V to 6V input supply.

**■ Typical Circuit**

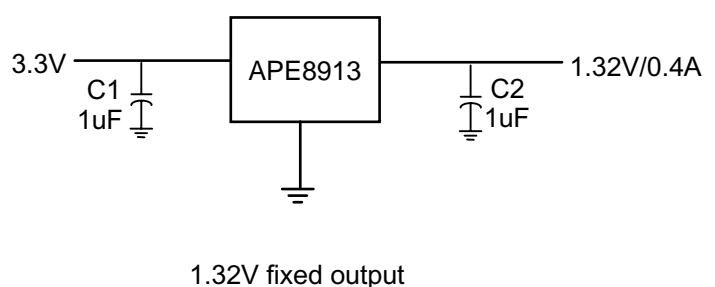
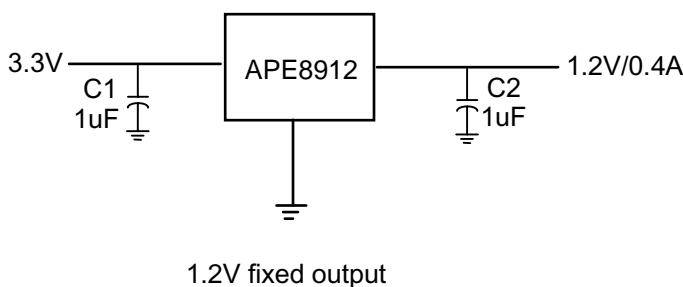



■ **Connection Diagram**

**SOT23 (N)**

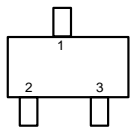

TOP VIEW  
1. VOUT  
2. GND  
3. VIN

**SOT23 (NR)**

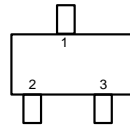

TOP VIEW  
1. VIN  
2. GND  
3. VOUT

■ **Block Diagram**

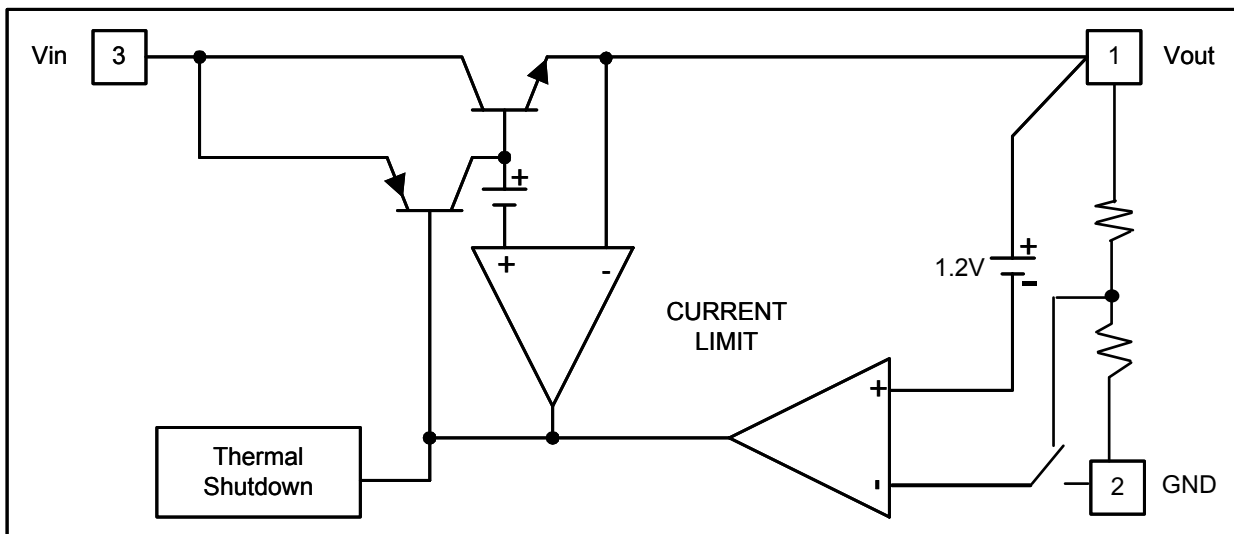



■ **Pin Descriptions**

NAME	I/O	PIN #		FUNCTION
		N	NR	
Vout	O	1	3	The output of the regulator. A minimum of 1uF capacitor must be connected from this pin to ground to insure stability.
GND	I	2	2	Ground
Vin	I	3	1	The input pin of regulator. A minimum of 1uF is connected from this pin to ground to insure that the input voltage does not sag below the minimum dropout voltage during the load transient response. This pin must always be 1.2V higher than Vout in order for the device to regulate properly.

■ **Absolute Maximum Ratings**

Symbol	Parameter	Rating	Unit
Vin	DC Supply Voltage	-0.3 to 6	V
P <sub>D</sub>	Power Dissipation	Internally Limited	
T <sub>ST</sub>	Storage Temperature	-65 to +150	°C
T <sub>OP</sub>	Operating Junction Temperature Range	0 to +150	°C



**1.2V/1.32V 0.4A Low Dropout Fixed-Mode Regulator**

**■ Electrical Characteristics** (Under Operating Conditions)

PARAMETER	CONDITIONS		MIN	TYP	MAX	UNIT
Output Voltage	APE8912	$I_{OUT} = 10\text{mA}, T_J = 25^\circ\text{C},$ $V_{OUT} + 1.2\text{V} \leq V_{IN} \leq 6\text{V}$	1.176	1.2	1.224	V
	APE8913		1.294	1.320	1.346	V
Line Regulation	APE8912/3	$I_O = 10\text{mA}, V_{OUT} + 1.5\text{V} < V_{IN} < 6\text{V},$ $T_J = 25^\circ\text{C}$			0.2	%
Load Regulation	APE8912/3	$V_{IN} = 3.3\text{V}, V_{adj} = 10\text{mA} < I_O < 0.4\text{A},$ $T_J = 25^\circ\text{C}$ (Note 1,2)			1	%
Dropout Voltage ( $V_{IN} - V_{OUT}$ )	APE8912/3	$I_{OUT} = 0.4\text{A}, \Delta V_{OUT} = 1\% V_{OUT}$		1.1	1.2	V
Current Limit	APE8912/3	$V_{IN} = 3.3\text{V}$	0.4	1.1		A
Minimum Load Current	APE8912/3	$0^\circ\text{C} \leq T_J \leq 125^\circ\text{C}$		3	5	mA
Thermal Regulation	$T_A = 25^\circ\text{C}, 30\text{ms pulse}$			0.008	0.04	%/W
Ripple Rejection	$F = 120\text{Hz}, C_{OUT} = 25\mu\text{F Tantalum}, I_{OUT} = 1\text{A}$					
	APE8912/3	$V_{IN} = V_{OUT} + 3\text{V}$		60	70	dB
Temperature Stability	$I_O = 10\text{mA}$			0.5		%
$\theta_{JA}$ Thermal Resistance Junction-to-Ambient(No heat sink ;No air flow)	SOT23			250		$^\circ\text{C/W}$
$\theta_{JC}$ Thermal Resistance Junction-to-Case	SOT23 : Control Circuitry/Power Transistor			100		$^\circ\text{C/W}$

Note1: See thermal regulation specifications for changes in output voltage due to heating effects. Line and load regulation are measured at a constant junction temperature by low duty cycle pulse testing. Load regulation is measured at the output lead = 1/18" from the package.

Note2: Line and load regulation are guaranteed up to the maximum power dissipation of 5W. Power dissipation is determined by the difference between input and output differential and the output current. Guaranteed maximum power dissipation will not be available over the full input/output range.

Note3: Quiescent current is defined as the minimum output current required in maintaining regulation. At 6V input/output differential the device is guaranteed to regulate if the output current is greater than 10mA.



■ Typical Performance Characteristics

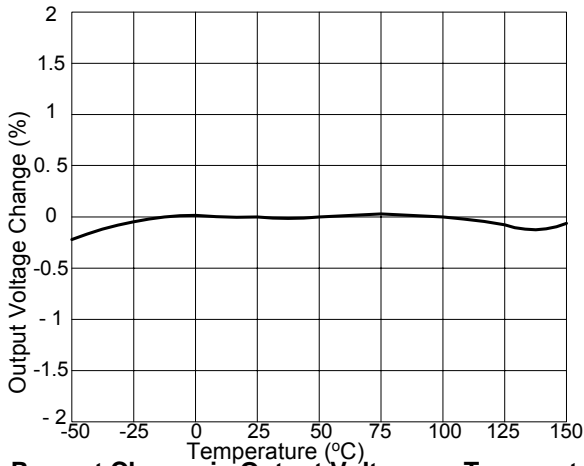

Percent Change in Output Voltage vs Temperature

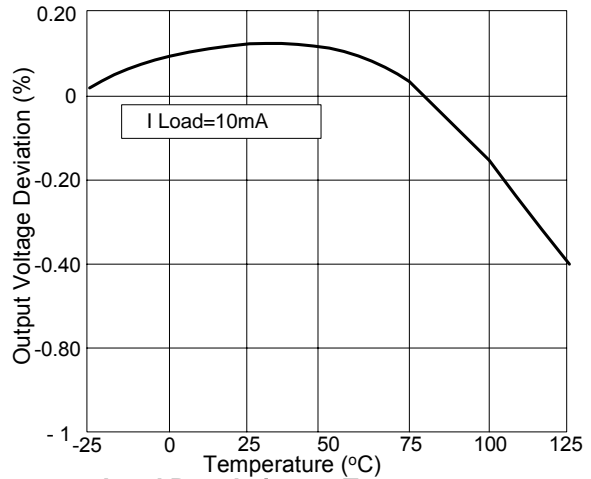

Load Regulation vs Temperature

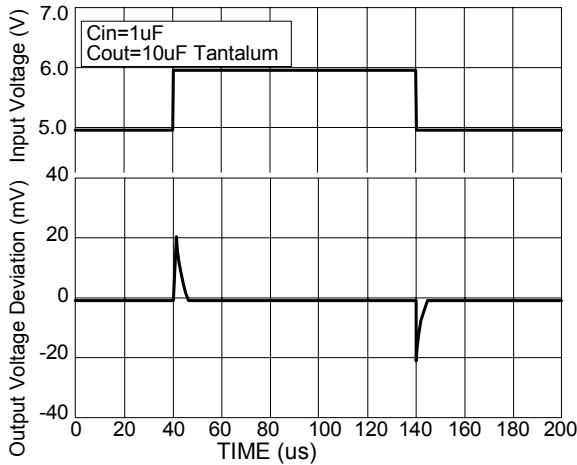

Line Transient Response

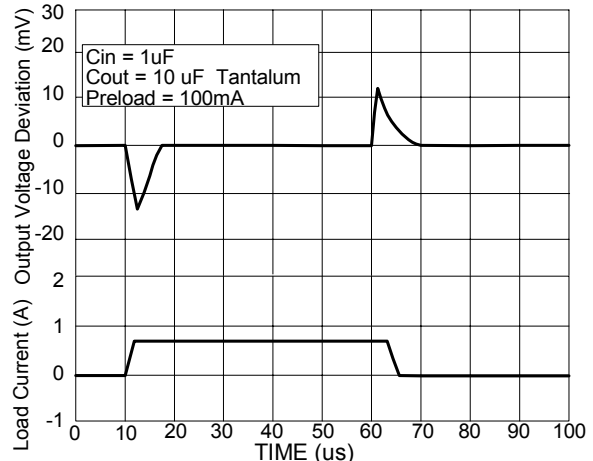

Load Transient Response