

V _{RSM}	V _{RRM}	(dv/dt) _{cr}	I _T RMS (maximum value for continuous operation)			
			75 A			
V	V	V/μs	I _{TAV} (sin. 180; T _{case} = 68 °C)			
			48 A			
500	400	500	–	–	SKKH 41/04 D	–
700	600	500	SKKT 41/06 D	SKKT 42/06 D	SKKH 41/06 D	SKKH 42/06 D
900	800	500	SKKT 41/08 D	SKKT 42/08 D ¹⁾	SKKH 41/08 D	SKKH 42/08 D
1300	1200	1000	SKKT 41/12 E	SKKT 42/12 E ¹⁾	SKKH 41/12 E	SKKH 42/12 E
1500	1400	1000	SKKT 41/14 E	SKKT 42/14 E ¹⁾	SKKH 41/14 E	SKKH 42/14 E
1700	1600	1000	SKKT 41/16 E	SKKT 42/16 E ¹⁾	SKKH 41/16 E	SKKH 42/16 E
1900	1800	1000	SKKT 41/18 E	SKKT 42/18 E ¹⁾	SKKH 41/18 E	SKKH 42/18 E
2100	2000	1000	SKKT 41/20 E	SKKT 42/20 E ¹⁾	–	–
2300	2200	1000	SKKT 41/22 E	SKKT 42/22 E ¹⁾	–	–

SEMIKRON® 1 Thyristor / Diode Modules

SKKT 41 SKKH 41
SKKT 42 SKKH 42
SKKT 42B SKKL 42 ²⁾

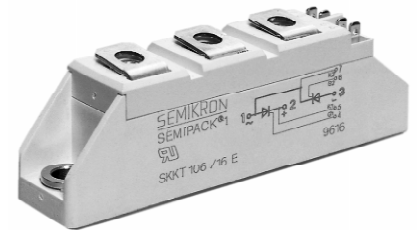

Symbol	Conditions	SKKT 41 SKKH 41	SKKT 42 SKKT 42B SKKH 42	Units
I _{TAV}	sin. 180; T _{case} = 74 °C T _{case} = 85 °C		48 40	A A
I _D	B2/B6 T _{amb} = 45 °C; P 3/180 T _{amb} = 35 °C; P 3/180 F		50 / 60 85 / 110	A A
I _{RMS}	W1/W3 T _{amb} = 35 °C; P 3/180 F		110 / 3 x 85	A
I _{TSM}	T _{vj} = 25 °C; 10 ms T _{vj} = 125 °C; 10 ms		1 000 850	A A
i ² t	T _{vj} = 25 °C; 8,3 ... 10 ms T _{vj} = 125 °C; 8,3 ... 10 ms		5 000 3 600	A ² s A ² s
t _{gd}	T _{vj} = 25 °C; I _G = 1 A di _G /dt = 1 A/μs		1	μs
t _{gr}	V _D = 0,67 · V _{DRM}		2	μs
(di/dt) _{cr}	T _{vj} = 125 °C		150	A/μs
t _q	T _{vj} = 125 °C		typ. 80	μs
I _H	T _{vj} = 25 °C; typ./max.		150 / 250	mA
I _L	T _{vj} = 25 °C; R _G = 33 Ω; typ./max.		300 / 600	mA
V _T	T _{vj} = 25 °C; I _T = 200 A		max. 1,95	V
V _{T(TO)}	T _{vj} = 125 °C		1	V
r _T	T _{vj} = 125 °C		4,5	mΩ
I _{DD} ; I _{RD}	T _{vj} = 125 °C; V _{RD} = V _{RRM} V _{DD} = V _{DRM}		max. 15 ³⁾	mA
V _{GT}	T _{vj} = 25 °C; d.c.		3	V
I _{GT}	T _{vj} = 25 °C; d.c.		150	mA
V _{GD}	T _{vj} = 125 °C; d.c.		0,25	V
I _{GD}	T _{vj} = 125 °C; d.c.		6	mA
R _{thjc}	cont.		0,65 / 0,33	°C/W
R _{thch}	sin. 180 } per thyristor / rec. 120 } per module		0,69 / 0,35	°C/W
			0,73 / 0,37	°C/W
			0,2 / 0,1	°C/W
T _{vj}			– 40 ... + 125	°C
T _{stg}			– 40 ... + 125	°C
V _{isol}	a. c. 50 Hz; r.m.s.; 1 s/1 min		3600 / 3000	V~
M ₁	to heatsink } SI (US) units to terminals }		5 (44 lb. in.) ± 15 % ⁴⁾	Nm
M ₂			3 (26 lb. in.) ± 15 %	Nm
a			5 · 9,81	m/s ²
w	approx.		95	g
Case	→ page B 1 – 95	SKKT 41: A 5 SKKH 41: A 6 SKKH 42: A 47	SKKL 42: A 59 SKKT 42: A 46 SKKT 42B: A 48	

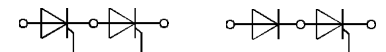

SKKT 41 SKKH 41



SKKT 42
SKKT 42B SKKH 42

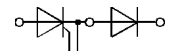

SKKL 42

Features

- Heat transfer through aluminium oxide ceramic isolated metal baseplate
- Hard soldered joints for high reliability
- UL recognized, file no. E 63 532

Typical Applications

- DC motor control (e.g. for machine tools)
- AC motor soft starters
- Temperature control (e.g. for ovens, chemical processes)
- Professional light dimming (studios, theaters)

¹⁾ Also available in SKKT 42 B configuration (case A 48)

²⁾ SKKL 42 available on request

³⁾ /20 E, /22 E max. 30 mA

⁴⁾ See the assembly instructions

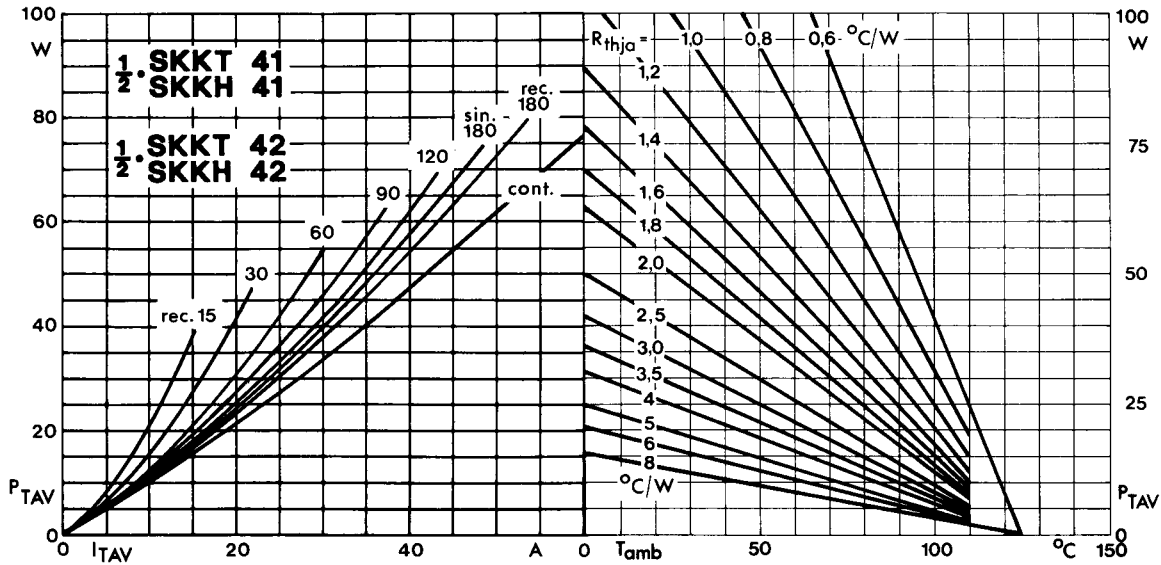

Fig. 1 Power dissipation per thyristor vs. on-state current and ambient temperature

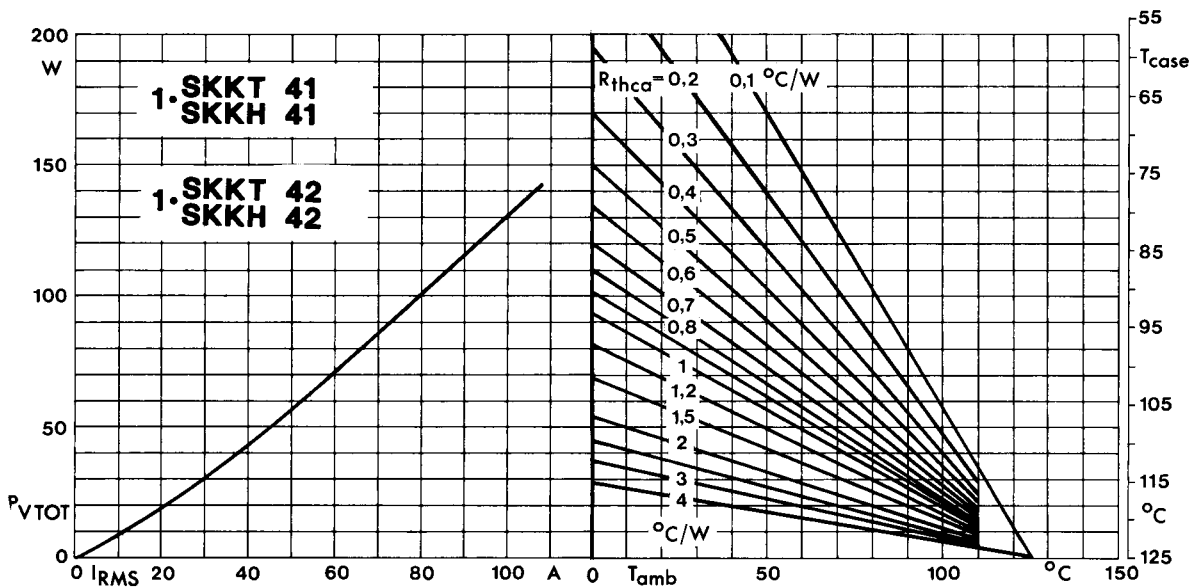

Fig. 2 Power dissipation per module vs. rms current and case temperature

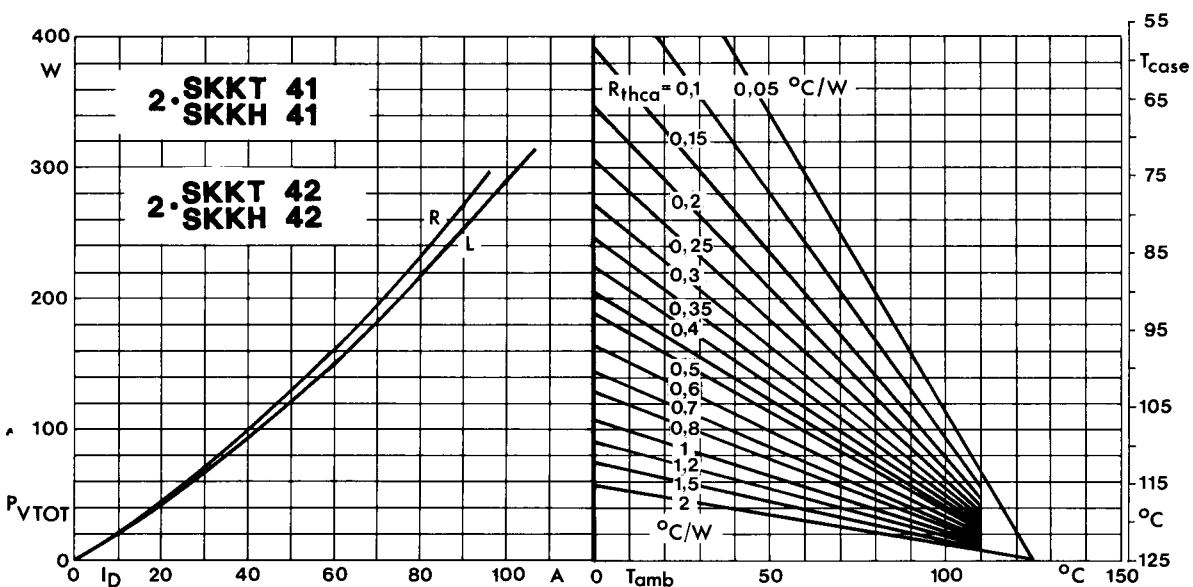

Fig. 3 Power dissipation of two modules vs. direct current and case temperature

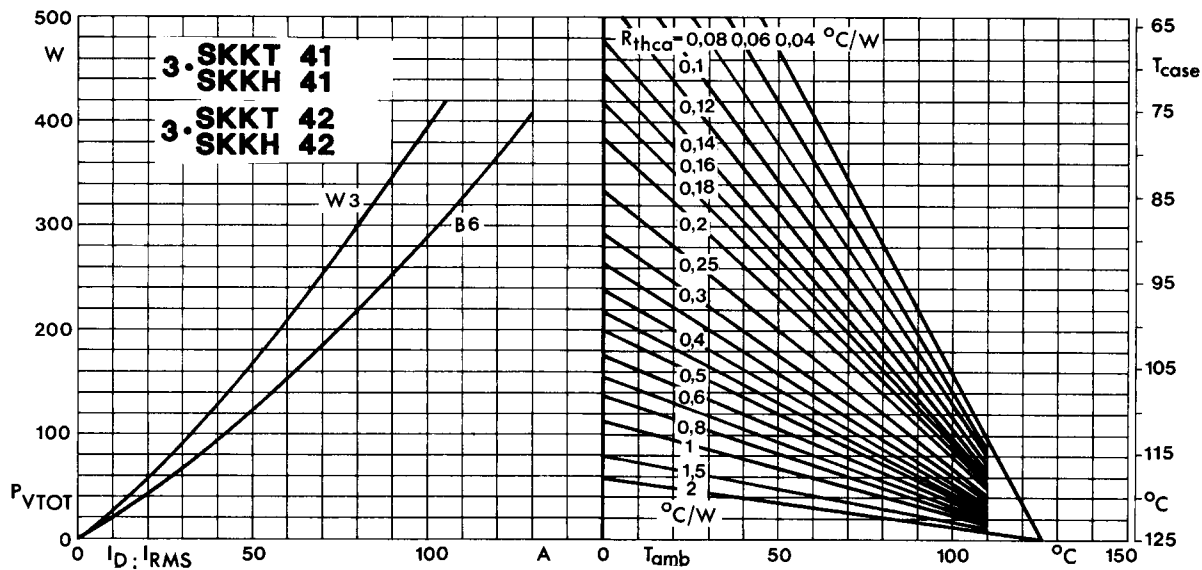

Fig. 4 Power dissipation of three modules vs. direct and rms current and case temperature

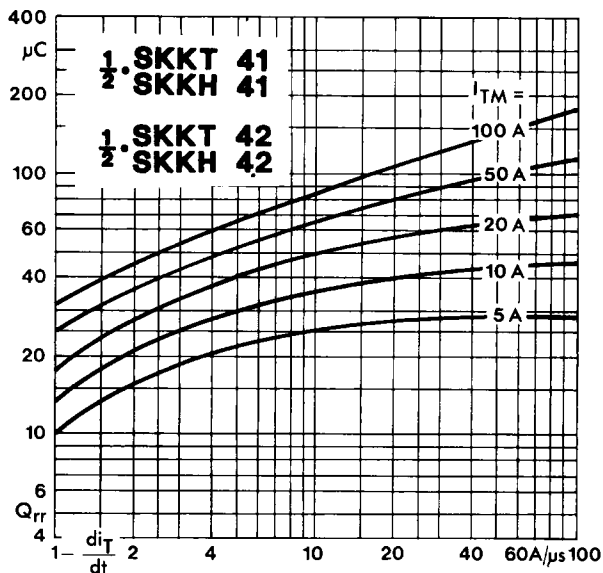

Fig. 5 Recovered charge vs. current decrease

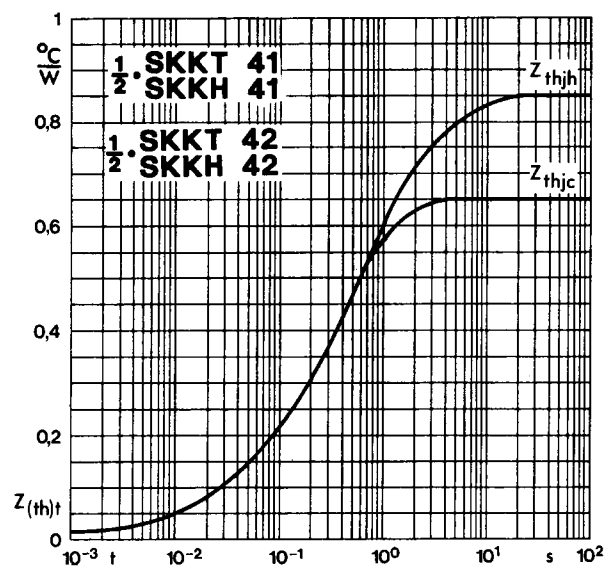

Fig. 6 Transient thermal impedance vs. time

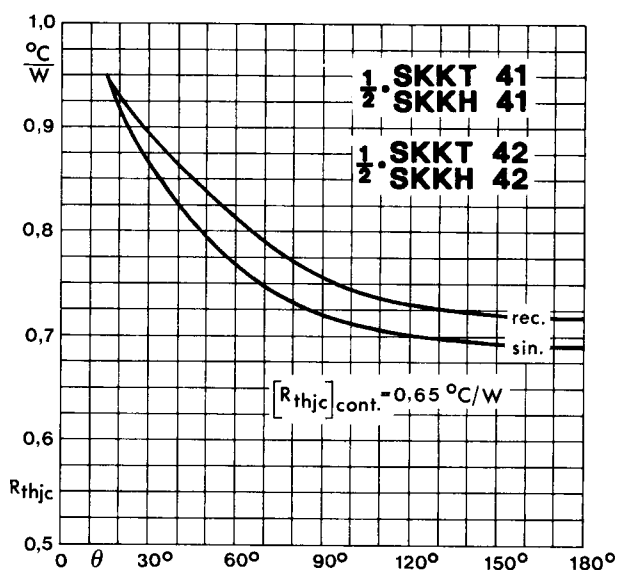

Fig. 7 Thermal resistance vs. conduction angle

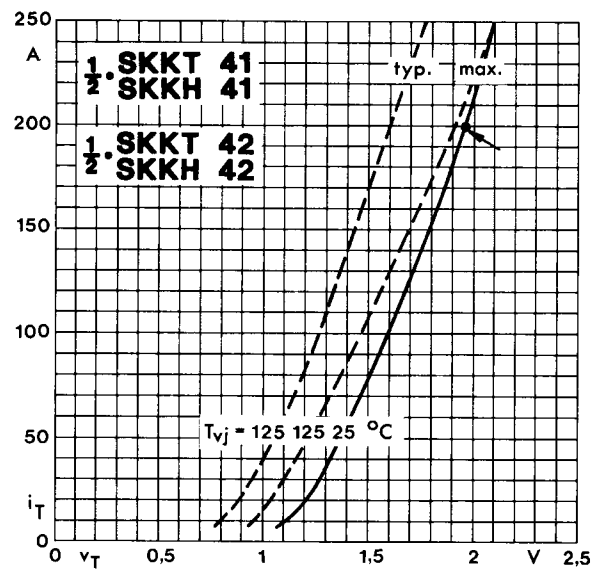

Fig. 8 On-state characteristics

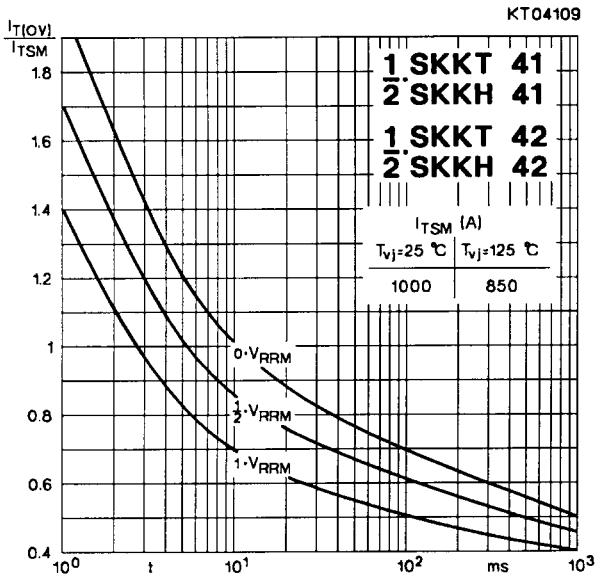

Fig. 9 Surge overload current vs. time

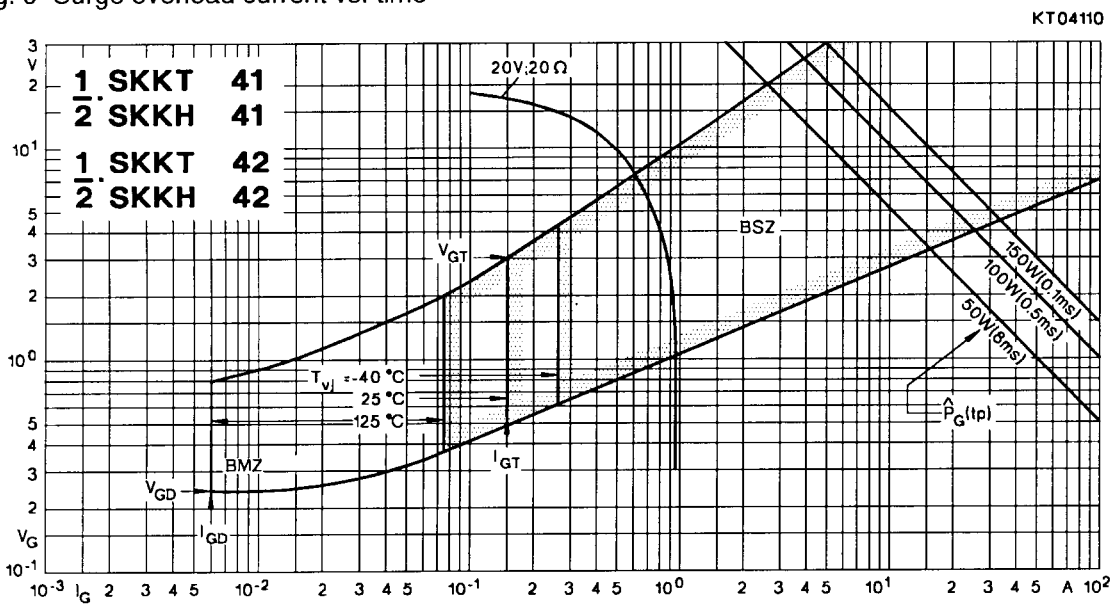

Fig. 10 Gate trigger characteristics

SKKT 19 ... 105

Case A 5

IEC 192-2: A 77 A

JEDEC: TO-240 AA

SEMIPACK® 1

UL recognized, file no. E 63 532



Dimensions in mm

SKKT 20/ ... 106/

Case A 46

IEC 192-2: A 77 A

JEDEC: TO-240 AA

SEMIPACK® 1

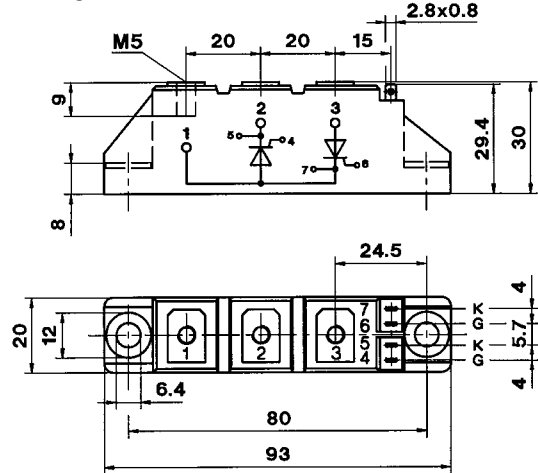

Dimensions in mm

SKKH 26 ... 105

Case A 6

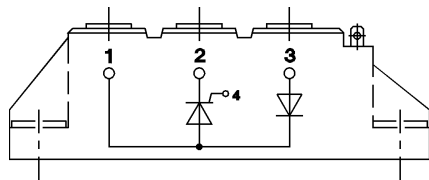

SKKD 26 ... 100

Case A 10

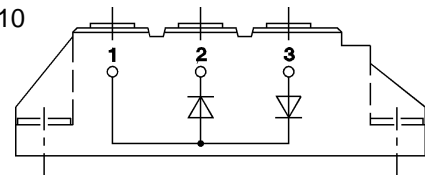

SKNH 56 ... 91

Case A 7

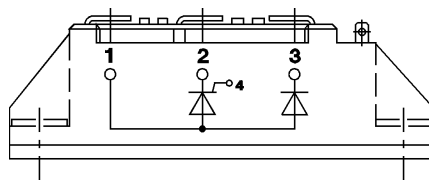

SKKE 81

Case A 12

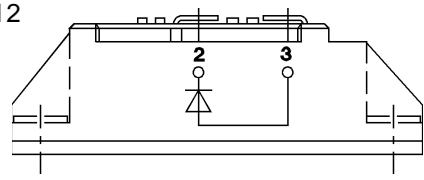

SKKL 56 ... 105

Case A 9

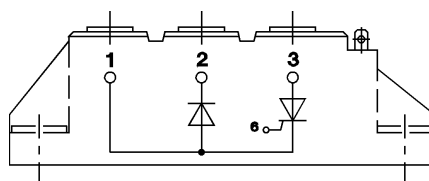

SKKH 27 ... 106

Case A 47

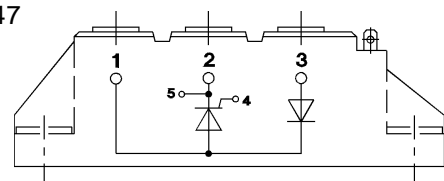

SKND 46 ... 81

Case A 19

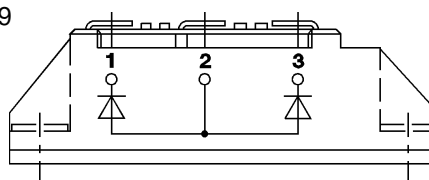

SKKT 20 B ... 106 B

Case A 48

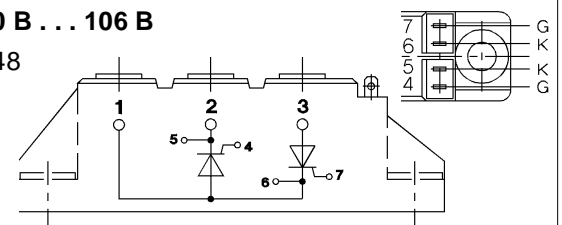

SKMT 92

Case A 72

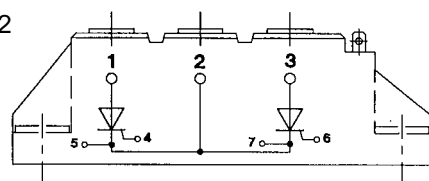

SKKL 42 ... 106

Case A 59

