

SEMiX 252GB176HD

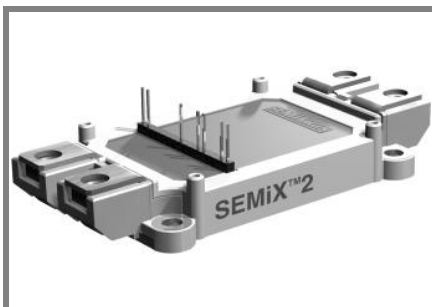

SEMiX[®] 2

Trench IGBT Modules

SEMiX 252GB176HD

Preliminary Data

Features

- Homogeneous Si
- Trench = Trenchgate technology
- $V_{CE(sat)}$ with positive temperature coefficient
- High short circuit capability

Typical Applications

- AC inverter drives
- UPS
- Electronic welders

Remarks

- short circuit capability is tested @ $V_{CC}=1000V$ (all other static parameters are tested @ $V_{CC}=1200V$)
- Not for new design

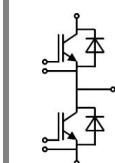

GB

Absolute Maximum Ratings		$T_{case} = 25^{\circ}C$, unless otherwise specified	
Symbol	Conditions	Values	Units
IGBT			
V_{CES}	$T_j = 25^{\circ}C$	1700	V
I_C	$T_j = 150^{\circ}C$	$T_c = 25^{\circ}C$	245
		$T_c = 80^{\circ}C$	175
I_{CRM}	$I_{CRM} = 2 \times I_{Cnom}$	300	A
V_{GES}		± 20	V
t_{psc}	$V_{CC} = 1200V$; $V_{GE} \leq 20V$; $T_j = 125^{\circ}C$ $V_{CES} < 1700V$	10	μs
Inverse Diode			
I_F	$T_j = 150^{\circ}C$	$T_c = 25^{\circ}C$	290
		$T_c = 80^{\circ}C$	195
I_{FRM}	$I_{FRM} = 2 \times I_{Fnom}$	300	A
I_{FSM}	$t_p = 10ms$; sin. $T_j = 25^{\circ}C$	1200	A
Module			
$I_{t(RMS)}$		600	A
T_{vj}		- 40 ... + 150	$^{\circ}C$
T_{stg}		- 40 ... + 125	$^{\circ}C$
V_{isol}	AC, 1 min.	4000	V

Characteristics		$T_{case} = 25^{\circ}C$, unless otherwise specified			
Symbol	Conditions	min.	typ.	max.	Units
IGBT					
$V_{GE(th)}$	$V_{GE} = V_{CE}$, $I_C = 6mA$	5,2	5,8	6,4	V
I_{CES}	$V_{GE} = 0V$, $V_{CE} = V_{CES}$	$T_j = 25^{\circ}C$		0,45	mA
		$T_j = 125^{\circ}C$			mA
V_{CE0}		$T_j = 25^{\circ}C$	1	1,2	V
		$T_j = 125^{\circ}C$	0,9	1,1	V
r_{CE}	$V_{GE} = 15V$	$T_j = 25^{\circ}C$	6,7	8,3	m Ω
		$T_j = 125^{\circ}C$	10,3	12	m Ω
$V_{CE(sat)}$	$I_{Cnom} = 150A$, $V_{GE} = 15V$		2	2,45	V
			2,45	2,9	V
C_{ies}			13,3		nF
C_{oes}	$V_{CE} = 25$, $V_{GE} = 0V$		0,55		nF
C_{res}			0,44		nF
Q_G	$V_{GE} = -8V \dots +15V$		1400		nC
$t_{d(on)}$	$R_{Gon} = 9\Omega$	$V_{CC} = 1200V$ $I_{Cnom} = 150A$ $T_j = 125^{\circ}C$	265		ns
t_r			55		ns
E_{on}			90		mJ
$t_{d(off)}$	$R_{Goff} = 9\Omega$		875		ns
t_f			125		ns
E_{off}			55		mJ
$R_{th(j-c)}$	per IGBT			0,12	K/W

SEMiX 252GB176HD

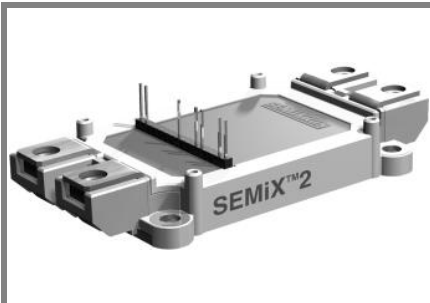

SEMiX[®] 2

Trench IGBT Modules

SEMiX 252GB176HD

Preliminary Data

Features

- Homogeneous Si
- Trench = Trenchgate technology
- $V_{CE(sat)}$ with positive temperature coefficient
- High short circuit capability

Typical Applications

- AC inverter drives
- UPS
- Electronic welders

Remarks

- short circuit capability is tested @ $V_{CC}=1000V$ (all other static parameters are tested @ $V_{CC}=1200V$)
- Not for new design



GB

Characteristics					
Symbol	Conditions	min.	typ.	max.	Units
Inverse Diode					
$V_F = V_{EC}$	$I_{Fnom} = 150 A; V_{GE} = 0 V$	$T_j = 25 ^\circ C_{chiplev.}$	1,55	1,75	V
		$T_j = 125 ^\circ C_{chiplev.}$	1,5	1,7	V
V_{F0}		$T_j = 25 ^\circ C$	1,1	1,3	V
		$T_j = 125 ^\circ C$	0,9	1,1	V
r_F		$T_j = 25 ^\circ C$	3		mΩ
		$T_j = 125 ^\circ C$	4		mΩ
I_{RRM}	$I_{Fnom} = 150 A$	$T_j = 125 ^\circ C$	205		A
Q_{rr}	$di/dt = 3300 A/\mu s$		55		μC
E_{rr}	$V_{GE} = -15 V; V_{CC} = 1200 V$		32		mJ
$R_{th(j-c)D}$	per diode			0,19	K/W
Module					
L_{CE}			18		nH
$R_{CC'+EE'}$	res., terminal-chip	$T_{case} = 25 ^\circ C$	0,7		mΩ
		$T_{case} = 125 ^\circ C$	1		mΩ
$R_{th(c-s)}$	per module		0,045		K/W
M_s	to heat sink M5		3	5	Nm
M_t	to terminals M6		2,5	5	Nm
w				250	g
Temperature sensor					
R_{100}	$T_c = 100^\circ C (R_{25} = 5 k\Omega)$		0,493±5%		kΩ
$B_{100/125}$	$R(T) = R_{100} \exp[B_{100/125} (1/T - 1/T_{100})]$; $T[K]; B$		3550±2%		K

This is an electrostatic discharge sensitive device (ESDS), international standard IEC 60747-1, Chapter IX.

This technical information specifies semiconductor devices but promises no characteristics. No warranty or guarantee expressed or implied is made regarding delivery, performance or suitability.

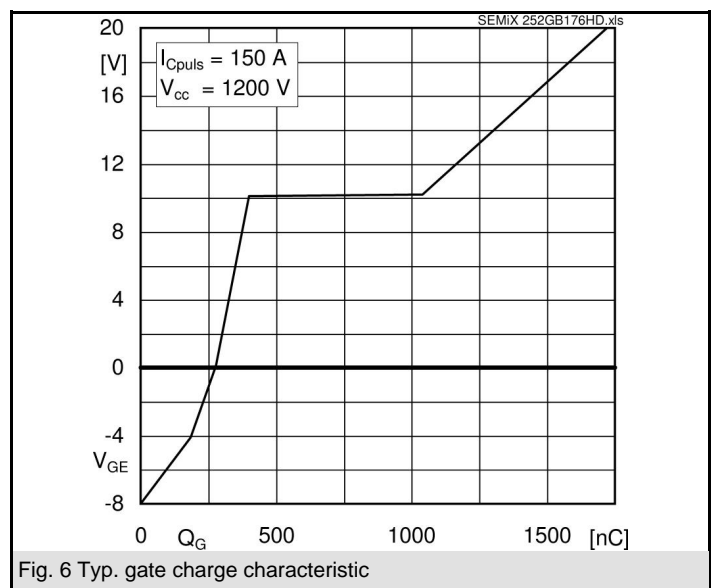
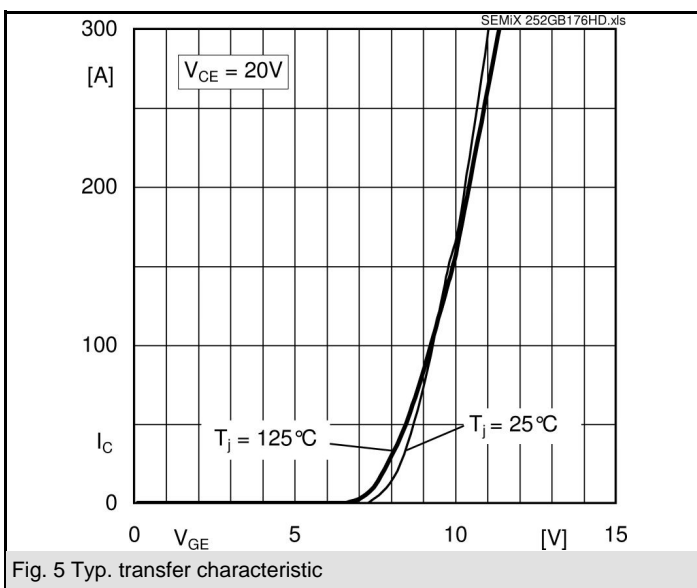
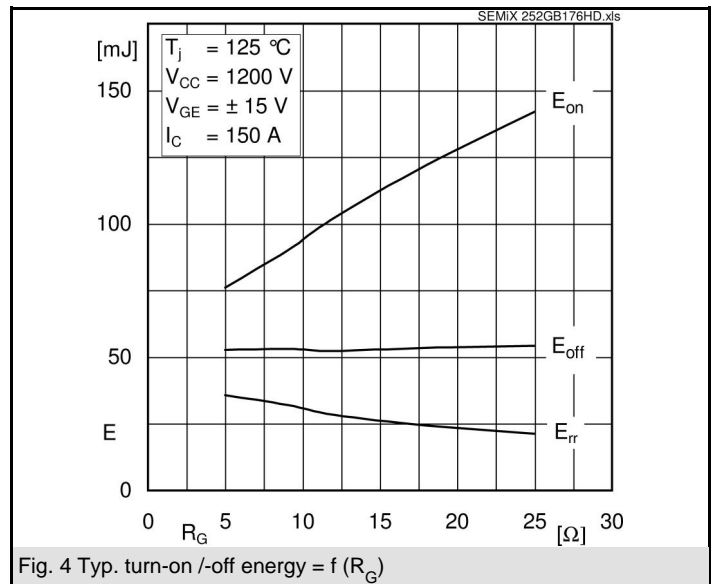
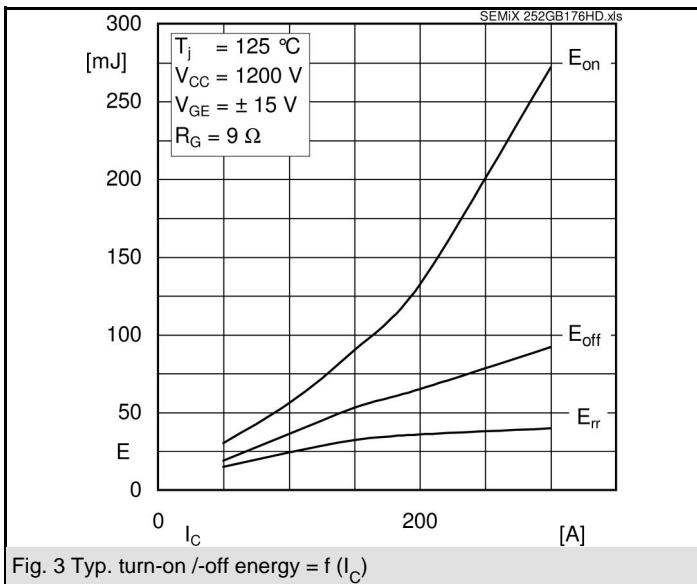
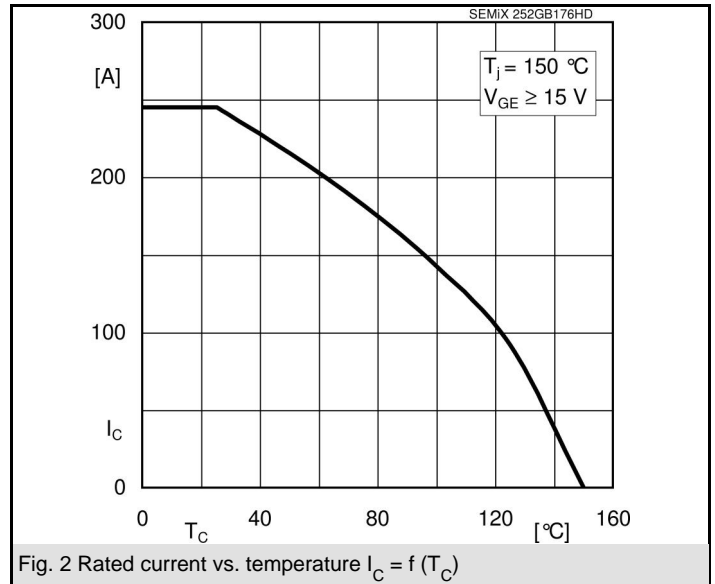
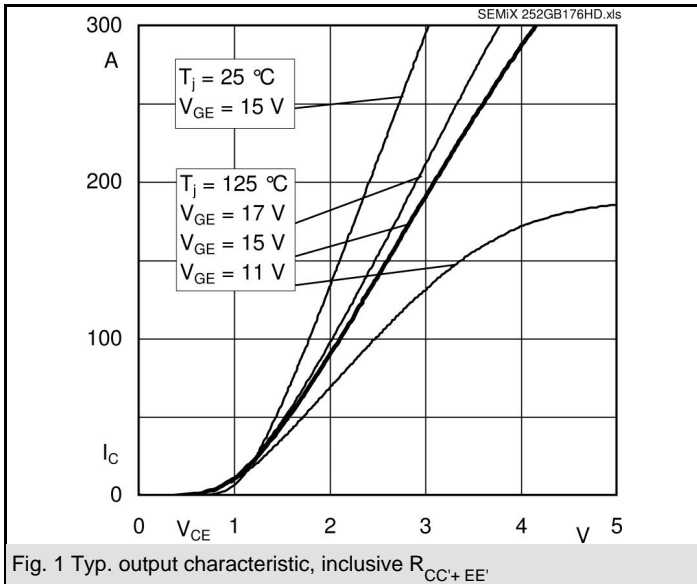

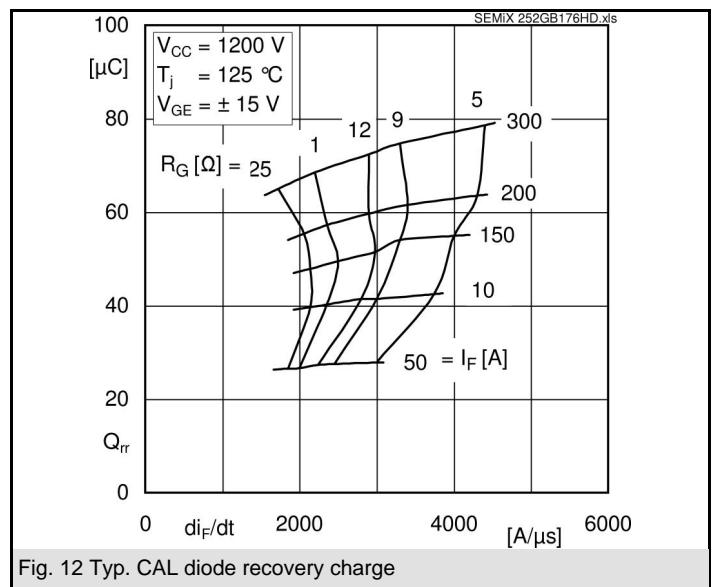
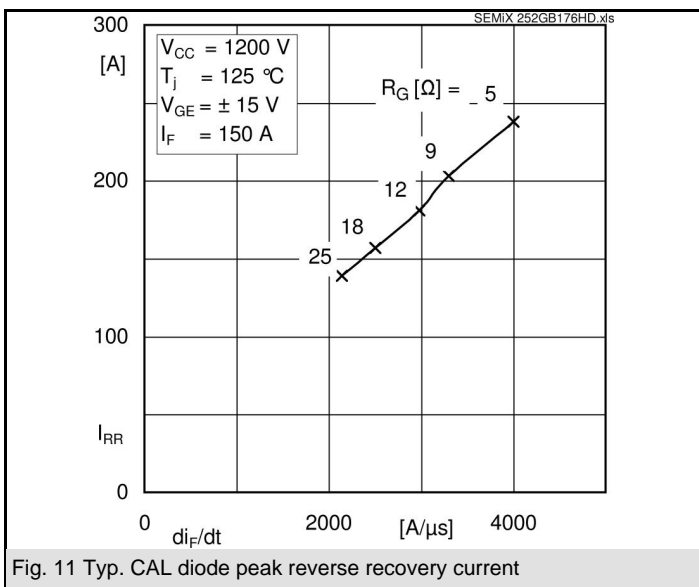
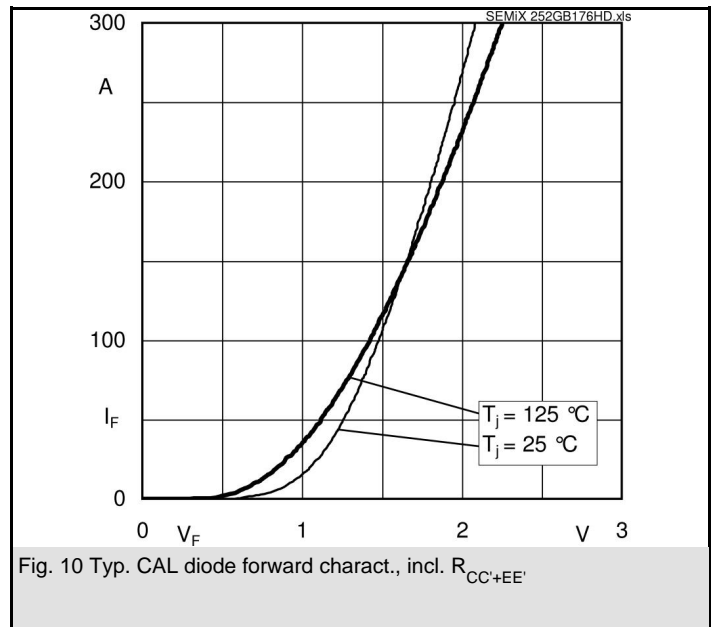
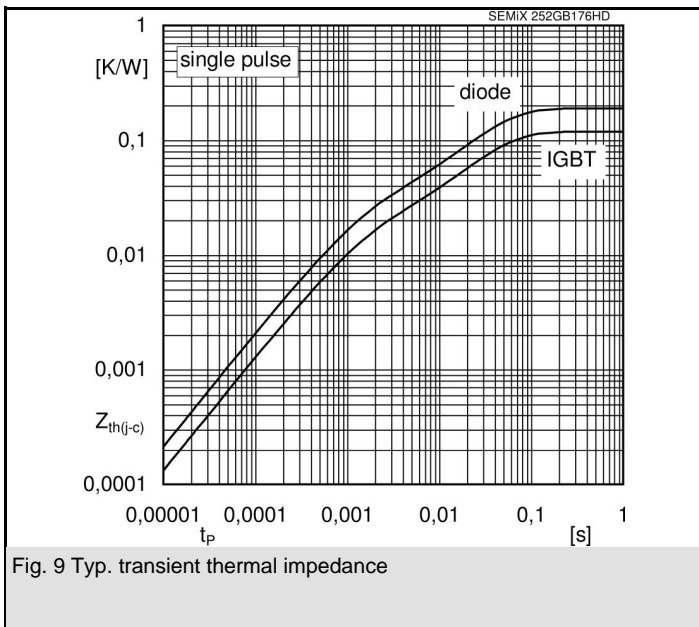
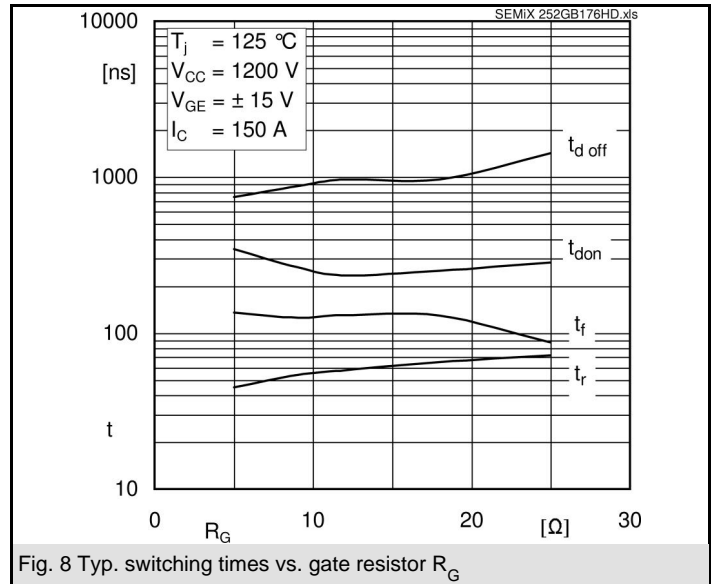
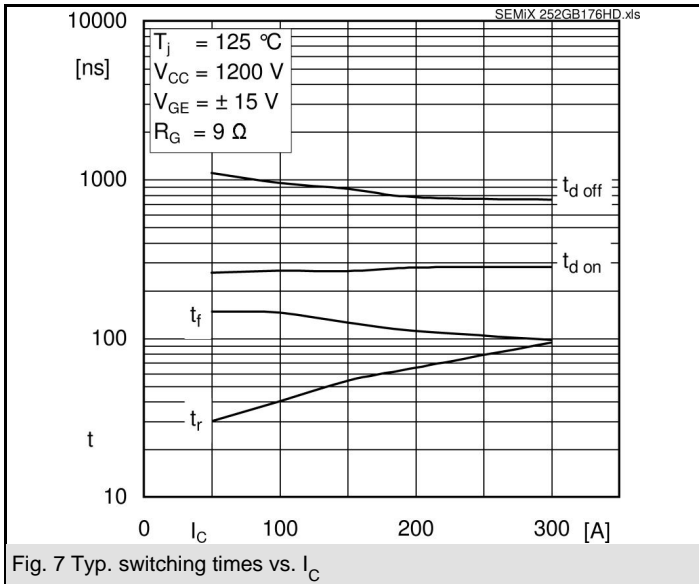

SEMiX 252GB176HD

case: SEMiX 2

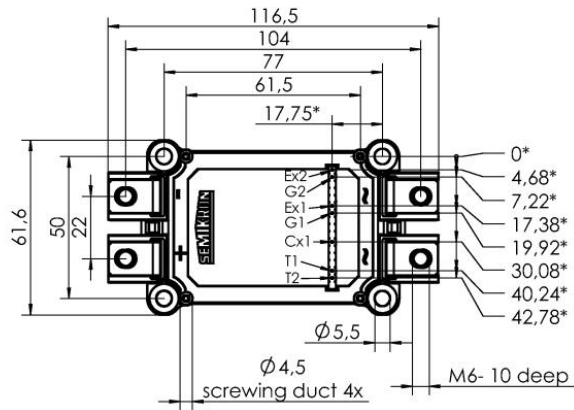
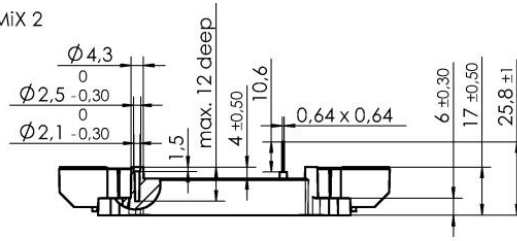

*= all measures with $\phi 0,5$

Case SEMiX 2

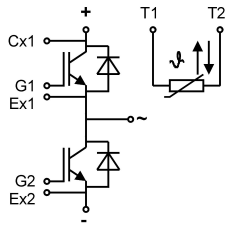

Pinout

GB