

Product Specification S8740280GT

GaAs Push Pull, 40 – 870MHz, 28.0dB min. Gain @ 870MHz, 260mA max. @ 24VDC



FEATURES

- Excellent linearity
- Superior return loss performance
- Extremely low distortion
- Optimal reliability
- Low noise
- Unconditionally stable under all terminations

APPLICATION

- 40 to 870 MHz CATV amplifier systems

DESCRIPTION

- Hybrid Push Pull amplifier module employing GaAs die

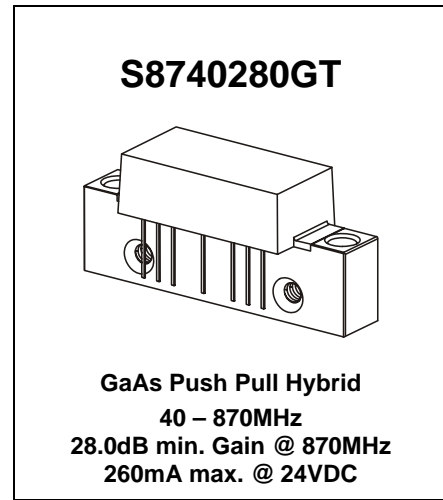

LIMITING VALUES

In accordance with the Absolute Maximum Rating System (IEC 60134)

SYMBOL	PARAMETER	MIN.	MAX.	UNIT
V_i	RF input voltage (single tone)	-	75	dBmV
V_{ov}	DC supply over-voltage (5 minutes)	-	30	V
T_{stg}	storage temperature	- 40	+ 100	°C
T_{mb}	operating mounting base temperature	- 30	+ 100	°C

CHARACTERISTICS

Table 1: S-Parameter, Noise Figure, DC Current; $V_B = 24V$; $T_{mb} = 30°C$; $Z_S = Z_L = 75 \Omega$

SYMBOL	PARAMETER	CONDITIONS	MIN.	TYP.	MAX.	UNIT
G_p	power gain	$f = 45 \text{ MHz}$	26.7	27.0	27.3	dB
		$f = 870 \text{ MHz}$	28.0	28.5	29.0	dB
SL	slope ¹⁾	$f = 45 \text{ to } 870 \text{ MHz}$	1.0	1.5	2.0	dB
FL	flatness of frequency response	$f = 45 \text{ to } 870 \text{ MHz}$	-		± 0.5	dB
S_{11}	input return loss	$f = 40 \text{ to } 550 \text{ MHz}$	20.0		-	dB
		$f = 550 \text{ to } 640 \text{ MHz}$	19.0		-	dB
		$f = 640 \text{ to } 870 \text{ MHz}$	18.0		-	dB
S_{22}	output return loss	$f = 40 \text{ to } 80 \text{ MHz}$	21.0		-	dB
		$f = 80 \text{ to } 160 \text{ MHz}$	19.0		-	dB
		$f = 160 \text{ to } 870 \text{ MHz}$	17.0		-	dB
F	noise figure	$f = 50 \text{ to } 870 \text{ MHz}$	-		5.0	dB
I_{tot}	total current consumption (DC)			250.0	260.0	mA

Notes:

1) The slope is defined as the difference between the gain at the start frequency and the gain at the stop frequency.

Product Specification
S8740280GT

GaAs Push Pull, 40 – 870MHz, 28.0dB min. Gain @ 870MHz, 260mA max. @ 24VDC



CHARACTERISTICS

Table 2: Distortion data 40 – 870 MHz; $V_B = 24V$; $T_{mb} = 30^{\circ}C$; $Z_S = Z_L = 75 \Omega$

SYMBOL	CONDITIONS	MIN.	TYP.	MAX.	UNIT
CTB	132 ch. flat; $V_o = 40 \text{ dBmV}^{1)}$	-		- 65	dBc
XMOD	132 ch. flat; $V_o = 40 \text{ dBmV}^{1)}$	-		- 58	dBc
CSO	132 ch. flat; $V_o = 40 \text{ dBmV}$; sum beats $^{1)}$	-		- 63	dBc

Notes:

1) 132 channels, NTSC frequency raster: 55.25 MHz to 865.25 MHz, +40 dBmV flat output level.

Composite Second Order (CSO)

The CSO parameter (both sum and difference products) is defined by the NCTA.

Composite Triple Beat (CTB)

The CTB parameter is defined by the NCTA.

Cross Modulation (XMOD)

Cross modulation (XMOD) is measured at baseband (selective voltmeter method), referenced to 100% modulation of the carrier being tested.

Product Specification S8740280GT

GaAs Push Pull, 40 – 870MHz, 28.0dB min. Gain @ 870MHz, 260mA max. @ 24VDC

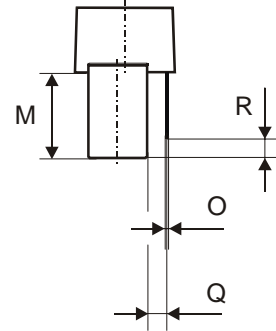
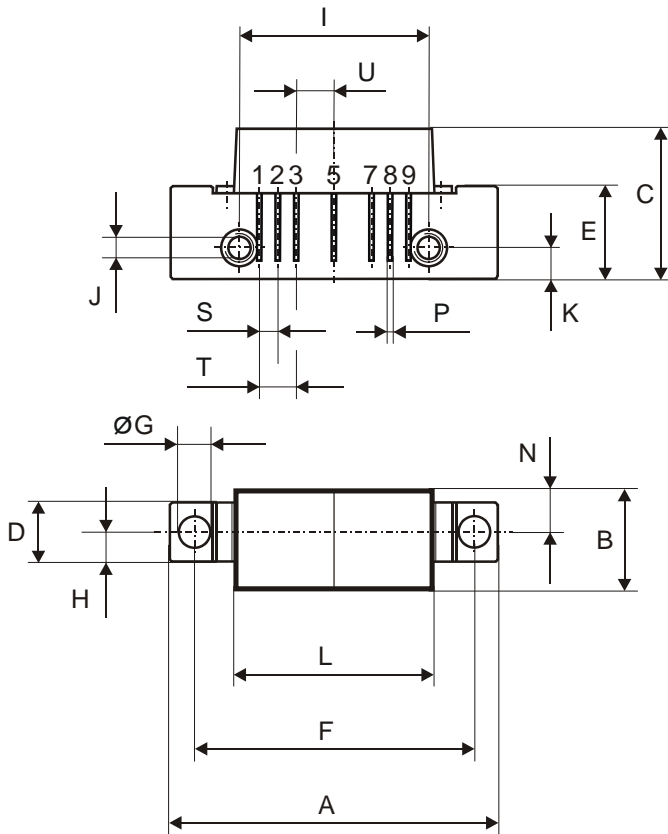

All Dimensions in mm:

	nominal	min	max
A	44,6 ± 0,2	44,4	44,8
B	13,6 ± 0,2	13,4	13,8
C	20,4 ± 0,5	19,9	20,9
D	8 ± 0,15	7,85	8,15
E	12,6 ± 0,15	12,45	12,75
F	38,1 ± 0,2	37,9	38,3
G	4 +0,2 / -0,05	3,95	4,2
H	4 ± 0,2	3,8	4,2
I	25,4 ± 0,2	25,2	25,6
J	UNC 6-32	-	-
K	4,2 ± 0,2	4,0	4,4
L	27,2 ± 0,2	27,0	27,4
M	11,6 ± 0,5	11,1	12,1
N	5,8 ± 0,4	5,4	6,2
O	0,25 ± 0,02	0,23	0,27
P	0,45 ± 0,03	0,42	0,48
Q	2,54 ± 0,3	2,24	2,84
R	2,54 ± 0,5	2,04	3,04
S	2,54 ± 0,25	2,29	2,79
T	5,08 ± 0,25	4,83	5,33
U	5,08 ± 0,25	4,83	5,33

Pinning:

	1	2	3	4	5	6	7	8	9
	INPUT	GND	GND	+VB	GND	GND	OUTPUT		

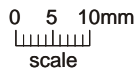

Notes:

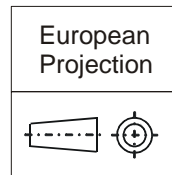

Product Specification
S8740280GT

GaAs Push Pull, 40 – 870MHz, 28.0dB min. Gain @ 870MHz, 260mA max. @ 24VDC



DEFINITIONS

Data Sheet Status	
Objective Product Specification	This data sheet contains target or goal specifications for product development.
Preliminary Product Specification	This data sheet contains preliminary data; supplementary data may be published later.
Product Specification	This data sheet contains final product specifications.
Limiting values	
Limiting values given are in accordance with the Absolute Maximum Rating System (IEC 60134). Stress above one or more of the limiting values may cause permanent damage to the device. These are stress ratings only and operation of the device at these or at any other conditions above those given in the Characteristics sections of the specification is not implied. Exposure to limiting values for extended periods may affect device reliability.	
Application information	
Where application information is given, it is advisory and does not form part of the specification.	

Premier Devices reserves the right to make changes without further notice to any products herein.

Premier Devices makes no warranty representation or guarantee regarding the suitability of its products for any particular purpose, nor does Premier Devices assume any liability arising out of the application or use of any product or circuit, and specifically disclaims any and all liability, including without limitation consequential or incidental damages. "Typical" parameters which may be provided in Premier Devices datasheets and/or specifications can and do vary in different applications and actual performance may vary over time. All operating parameters, including "Typicals" must be validated for each customer application by customer's technical experts. Premier Devices does not convey any license under its patent rights nor the rights of others. Premier Devices products are not designed, intended, or authorized for use as components in systems intended for surgical implant into the body, or other applications intended to support or sustain life, or for any other application in which the failure of the Premier Devices product could create a situation where personal injury or death may occur. Should Buyer purchase or use Premier Devices products for any such unintended or unauthorized application, Buyer shall indemnify and hold Premier Devices and its officers, employees, subsidiaries, affiliates, and distributors harmless against all claims, costs, damages, and expenses, and reasonable attorney fees arising out of, directly or indirectly, and claim of personal injury or death associated with such unintended or unauthorized use, even if such claim alleges that Premier Devices was negligent regarding the design or manufacture of the part.

© Premier Devices Germany GmbH 2005

How to contact us:



Premier Devices Germany GmbH

Loeffelholzstrasse 20, D-90441 Nuernberg, Germany

Phone: +49 (0) 911 9411 233, FAX: +49 (0) 911 9411 198,

Email: sales.germany@premierdevices.com, Internet: <http://www.premierdevices.de/>