

Features

- Four Inputs, Two Outputs Switch Matrix
- High Isolation
- Low DC Power Consumption
- Small TSSOP16 Plastic Package
- PHEMT process

TSSOP-16

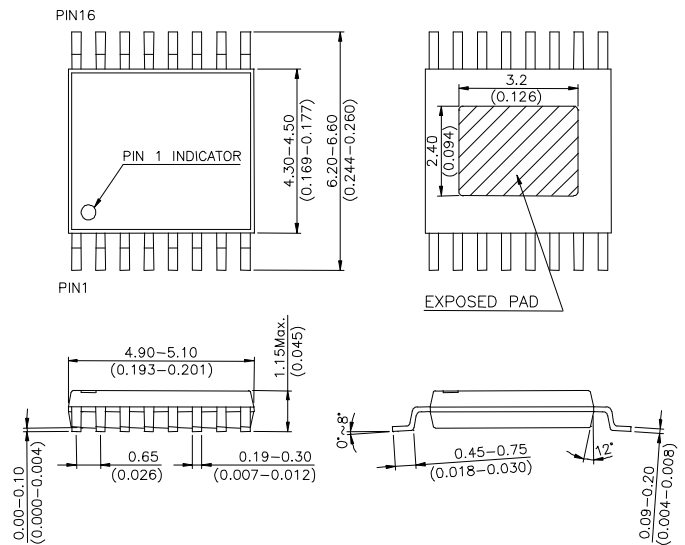

Description

The HWS412 is a GaAs PHEMT 4x2 switch matrix operating at 0.9 to 3.0 GHz in a low cost TSSOP16 plastic package. Any of the four inputs can be directed to any of the two outputs. The HWS412 is suitable for use in Direct Broadcast Satellite (DBS) switching system or CATV applications.

Electrical Specifications at 25 °C with 0V/+5V Control Voltages and 0 dBm Pin

Parameter	Test Conditions	Min.	Typ.	Max.	Unit
Insertion Loss	0.90-3.00 GHz		5.5	7.0	dB
Insertion Loss Flatness	0.90-3.00 GHz		1.5		dB
Isolation (Above Insertion Loss)	0.90-1.50 GHz	33	36		dB
	1.50-2.15 GHz	29	33		dB
	2.15-3.00 GHz	25	30		dB
Input Return Loss	0.90-3.00 GHz		10		dB
Output Return Loss	0.90-3.00 GHz		13		dB
Control Current	Per One Control Pin			100	uA

Note: 1. All measurements made in a 50 ohm system with 0/+5.0V control voltages, unless otherwise specified.

2. 'Isolation (Above Insertion Loss)' = | 'isolation (off-state)' - 'insertion loss (on-state)' |

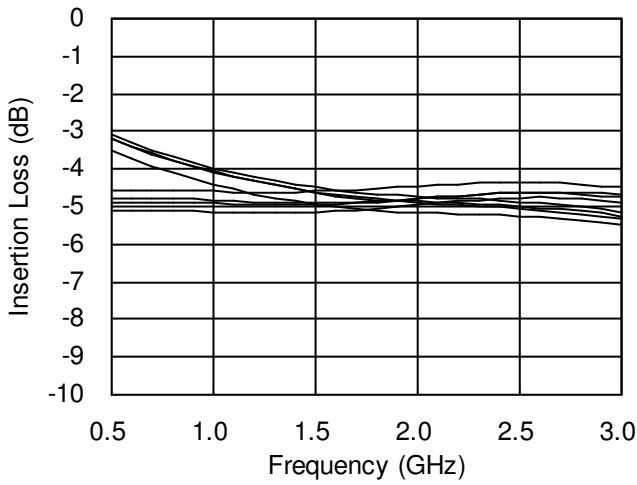
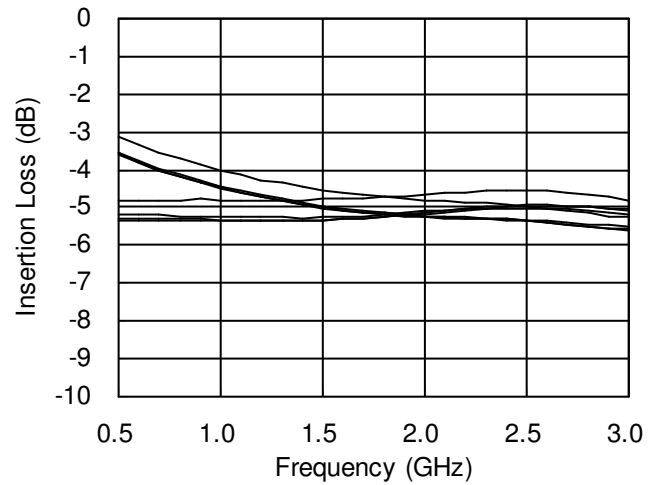
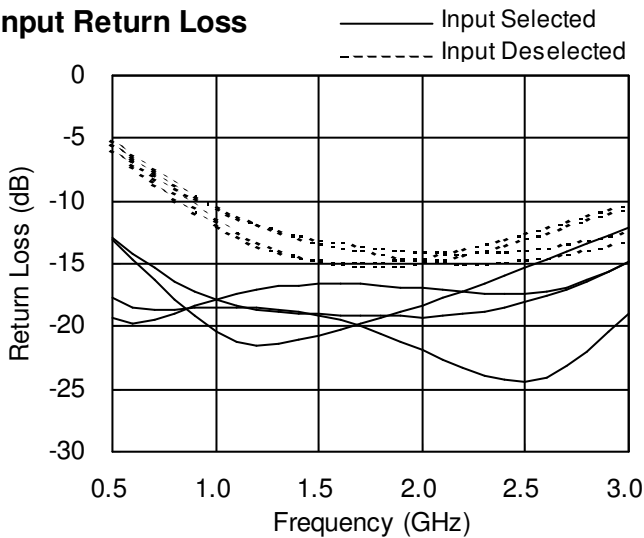
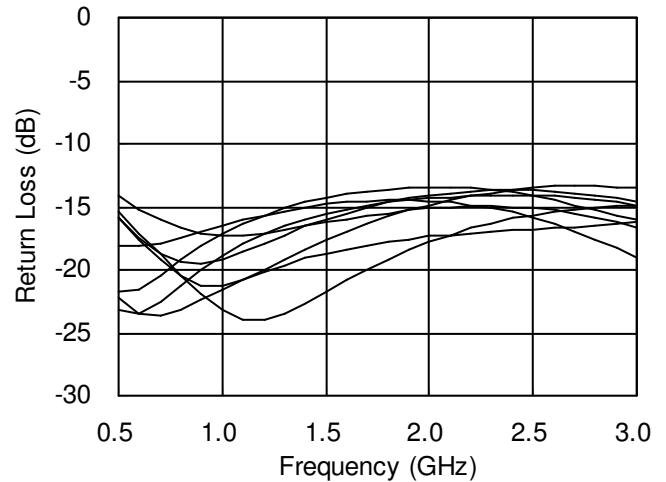
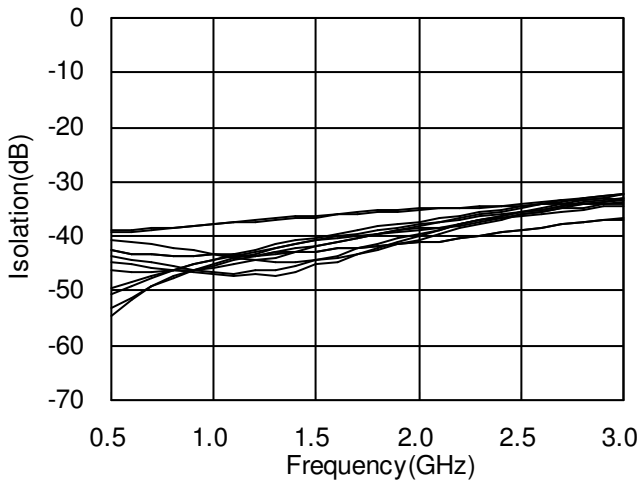
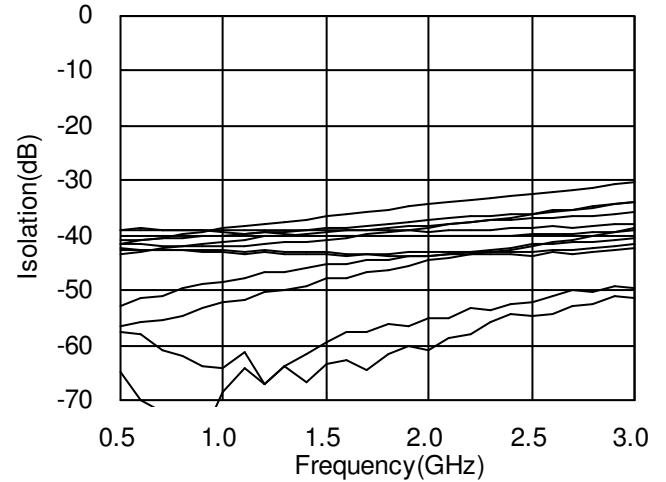
Typical Performance Data of Various States @ +25 °C
Insertion Loss on OUT1

Insertion Loss on OUT2

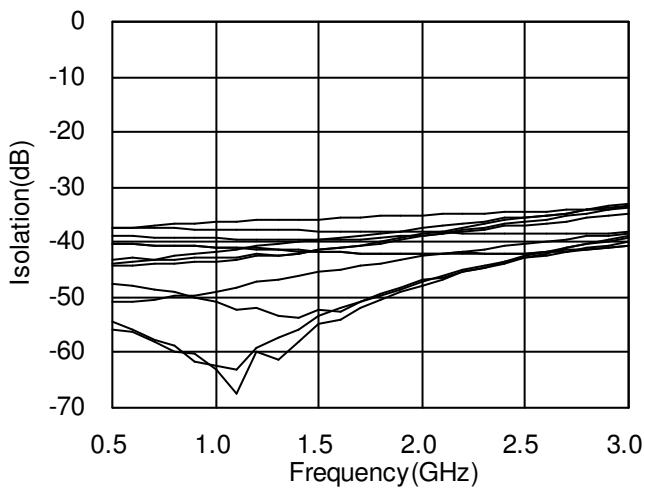
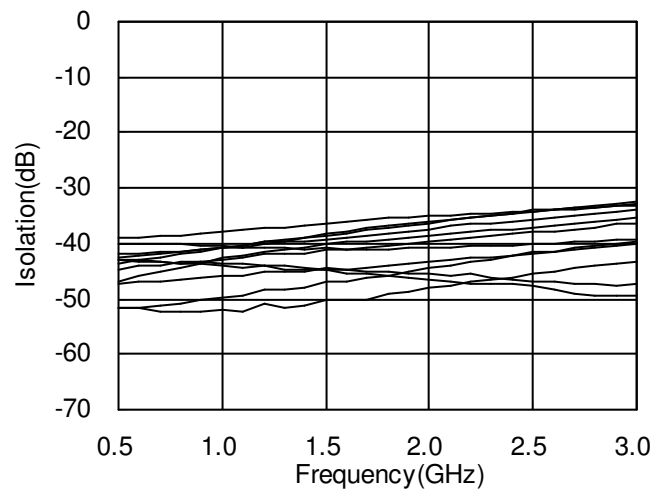
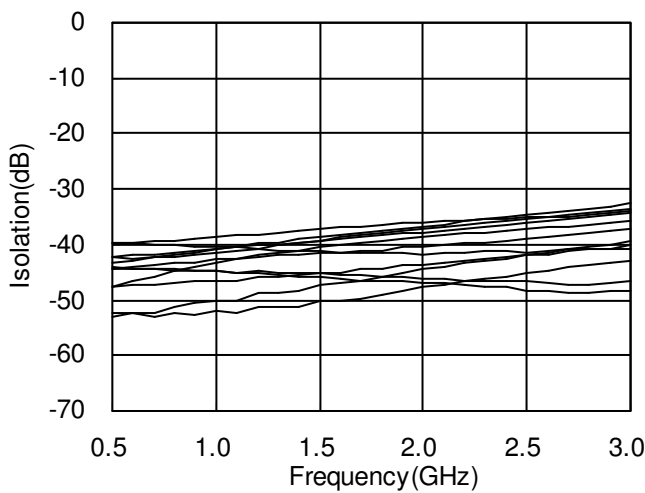
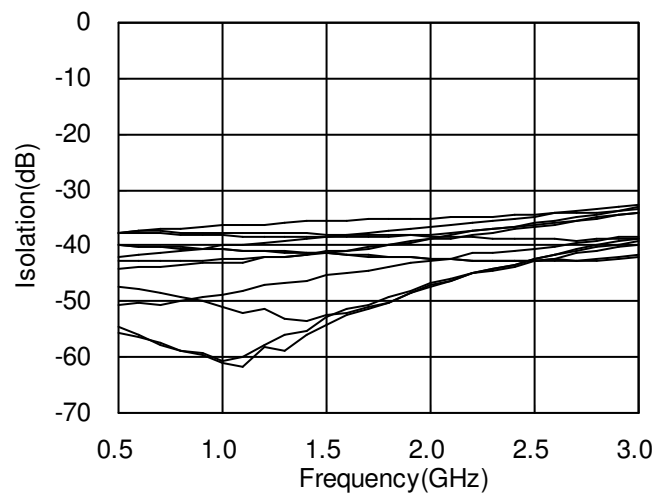
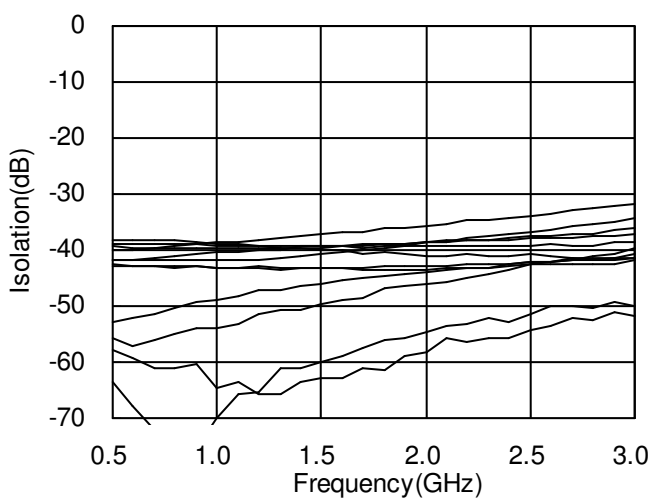
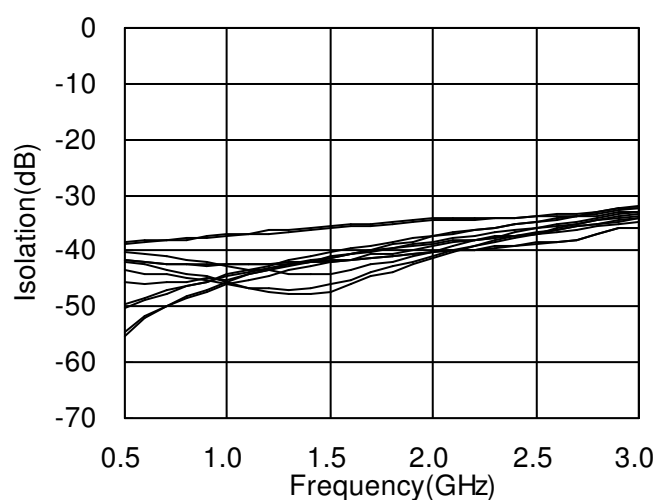
Input Return Loss

Output Return Loss

INA to OUT1 Isolation*

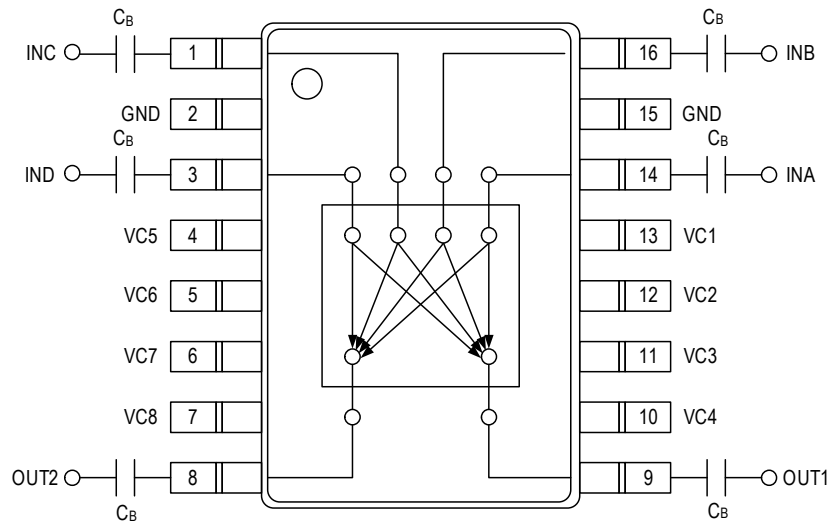
INA to OUT2 Isolation*

* Isolation is recorded above insertion loss.

INB to OUT1 Isolation***INB to OUT2 Isolation*****INC to OUT1 Isolation*****INC to OUT2 Isolation*****IND to OUT1 Isolation*****IND to OUT2 Isolation***

* Isolation is recorded above insertion loss.

Pin Out (Top View)



Note:

1. DC blocking capacitors $C_B=51\text{pF}$ are required on all RF ports.
2. Exposed pad in the bottom must be connected to ground by via holes.

Logic Table for Switch On-Path

On Path		Control Pins							
OUT1	OUT2	VC1	VC2	VC3	VC4	VC5	VC6	VC7	VC8
INA	-	1	0	1	0	-	-	-	-
INB	-	1	0	0	1	-	-	-	-
INC	-	0	1	1	0	-	-	-	-
IND	-	0	1	0	1	-	-	-	-
-	INA	-	-	-	-	1	0	1	0
-	INB	-	-	-	-	1	0	0	1
-	INC	-	-	-	-	0	1	1	0
-	IND	-	-	-	-	0	1	0	1

'1' = +5V

'0' = 0V

Recommended Operating Conditions
($T_A=+25^\circ\text{C}$)

Parameter	Min.	Typ.	Max.	Unit
Control Voltage (1)	+4.0	+5.0	+5.5	V
Control Voltage (0)	-0.5	0	+0.5	V

Absolute Maximum Ratings

Parameter	Absolute Maximum
RF Input Power	+15 dBm @ +6V
Control Voltage	+6V
Operating Temperature	-40 °C to +85 °C
Storage Temperature	-65 °C to +150 °C