

Typical Applications

The HMC373LP3 / HMC373LP3E is ideal for basestation receivers:

- GSM, GPRS & EDGE
- CDMA & W-CDMA
- Private Land Mobile Radio

Features

- Noise Figure: 0.9 dB
- +35 dBm Output IP3
- Gain: 14 dB
- Low Loss LNA Bypass Path
- Single Supply: +5.0 V @ 90 mA
- 50 Ohm Matched Output

Functional Diagram

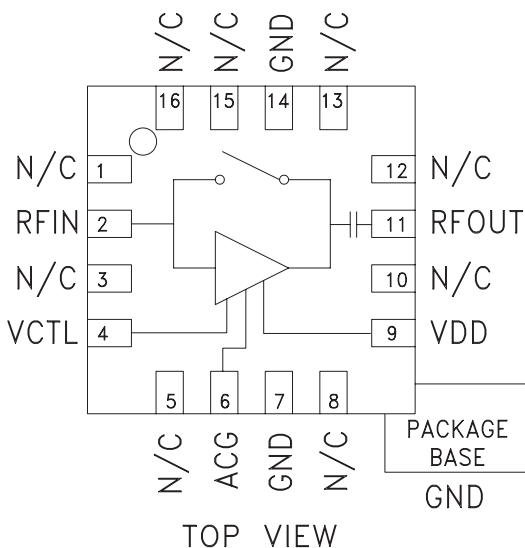

General Description

The HMC373LP3 / HMC373LP3E are versatile, high dynamic range GaAs MMIC Low Noise Amplifiers that integrate a low loss LNA bypass mode on the IC. The amplifier is ideal for GSM & CDMA cellular basestation front-end receivers operating between 700 and 1000 MHz and provides 0.9 dB noise figure, 14 dB of gain and +35 dBm IP3 from a single supply of +5.0V @ 90 mA. Input and output return losses are 28 and 12 dB respectively with the LNA requiring minimal external components to optimize the RF input match, RF ground and DC bias. By presenting an open or short circuit to a single control line, the LNA can be switched into a low 2.0 dB loss bypass mode reducing the current consumption to 10 μ A. A low cost, leadless 3x3 mm QFN surface mount package (LP3) houses the low noise amplifier.

Electrical Specifications, $T_A = +25^\circ\text{C}$, $V_{dd} = +5V$

Parameter	LNA Mode			LNA Mode			Bypass Mode			Units
	Min.	Typ.	Max.	Min.	Typ.	Max.	Min.	Typ.	Max.	
Frequency Range	810 - 960			700 - 1000			700 - 1000			MHz
Gain	11.5	13.5		10.5	14		-2.8	-2.0		dB
Gain Variation Over Temperature		0.008	0.015		0.008	0.015		0.002	0.004	dB / $^\circ\text{C}$
Noise Figure		0.9	1.3		1.0	1.4				dB
Input Return Loss		28			25			30		dB
Output Return Loss		12			11			25		dB
Reverse Isolation		20			19					dB
Power for 1dB Compression (P1dB)*	18	21		17	20			30		dBm
Saturated Output Power (P _{sat})		22.5			22					dBm
Third Order Intercept (IP3)* (-20 dBm Input Power per tone, 1 MHz tone spacing)		35.5			35			50		dBm
Supply Current (I _{dd})		90			90			0.01		mA

* P1dB and IP3 for LNA Mode are referenced to RFOUT while P1dB and IP3 for Bypass Mode are referenced to RFIN.

LNA Broadband Gain & Return Loss

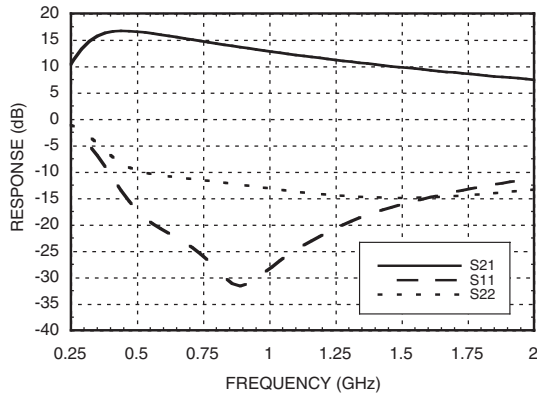

LNA – Gain, Noise Figure & Power vs. Supply Voltage @ 850 MHz

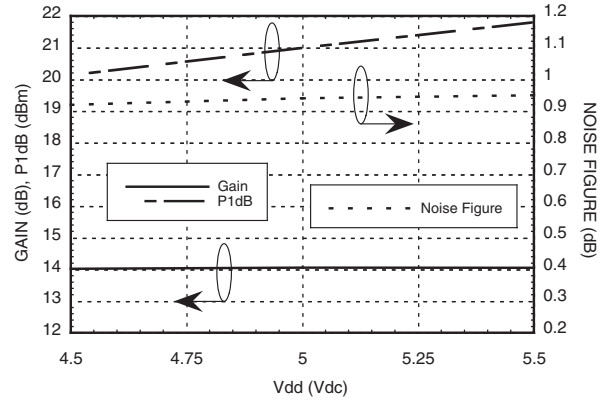

LNA Gain vs. Temperature

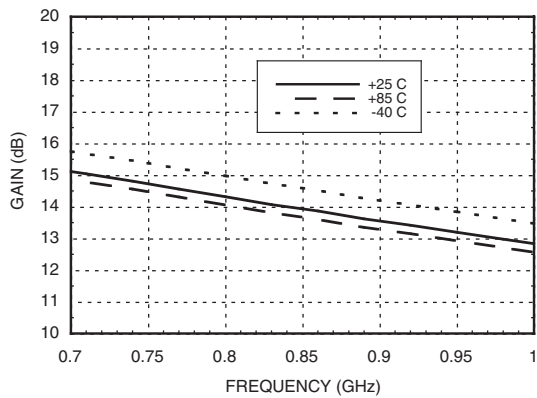

LNA Noise Figure vs. Temperature

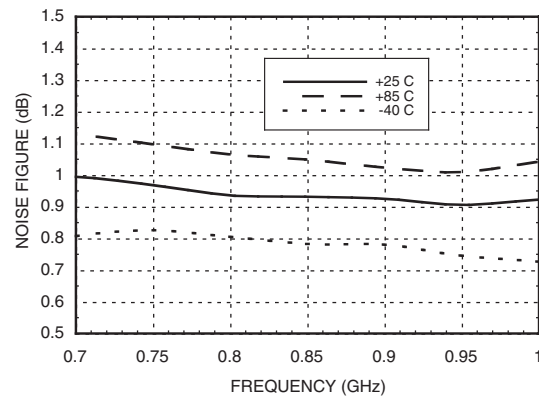

LNA Gain vs. Vdd

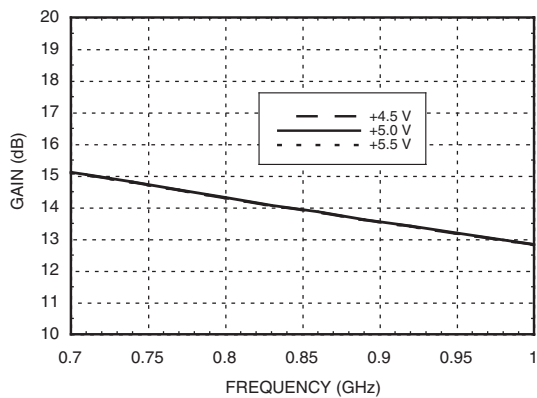

LNA Noise Figure vs. Vdd

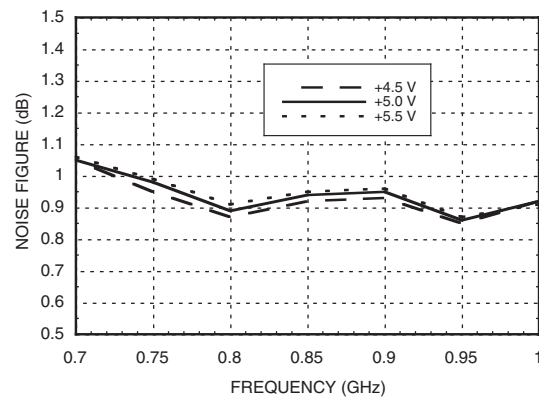

LNA Input Return Loss vs. Temperature

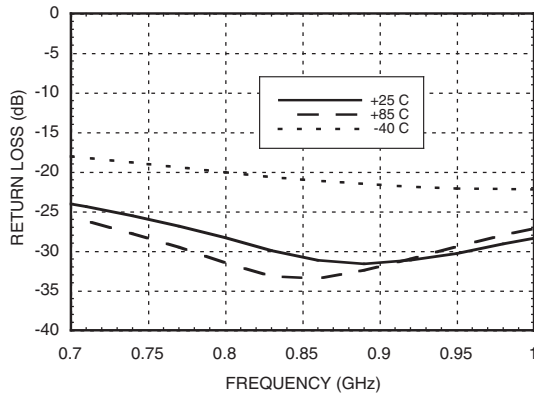

LNA Output Return Loss vs. Temperature

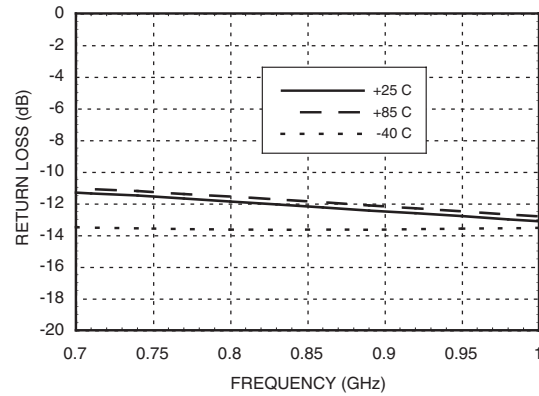

LNA Output IP3 vs. Temperature

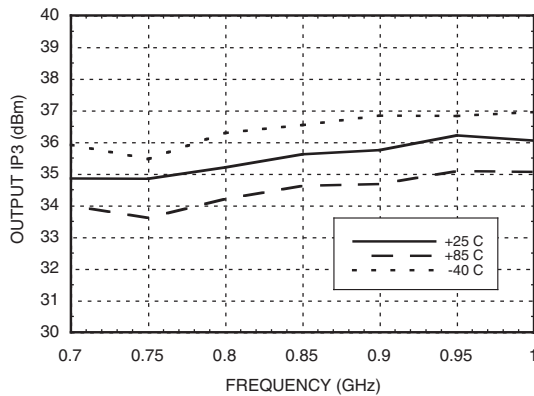

LNA P1dB & Psat vs. Temperature

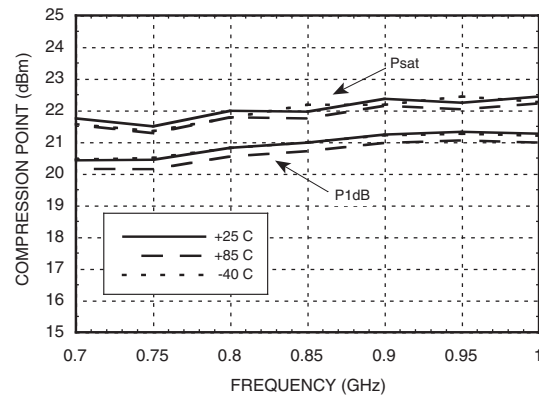

LNA Output IP3 vs. Vdd

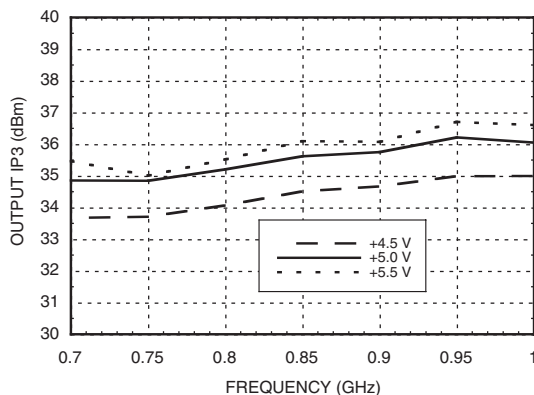

LNA P1dB vs. Vdd

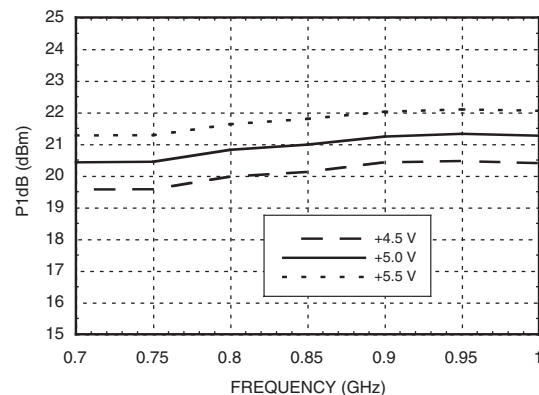



GaAs PHEMT MMIC LOW NOISE AMPLIFIER w/ BYPASS MODE, 700 - 1000 MHz

LNA Reverse Isolation vs. Temperature

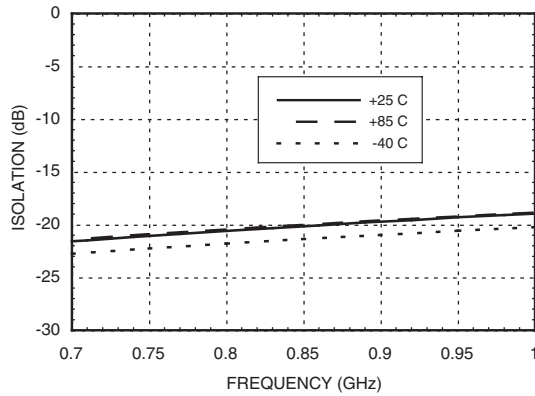

Bypass Mode Broadband Insertion Loss & Return Loss

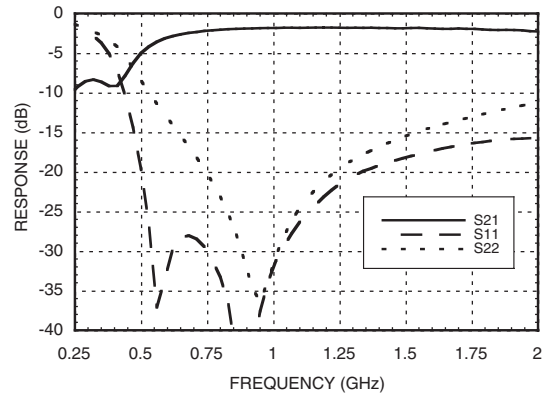

Bypass Mode Insertion Loss vs. Temperature

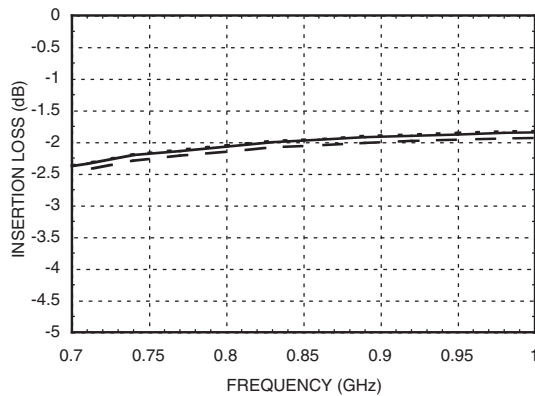

Bypass Mode Input Return Loss vs. Temperature

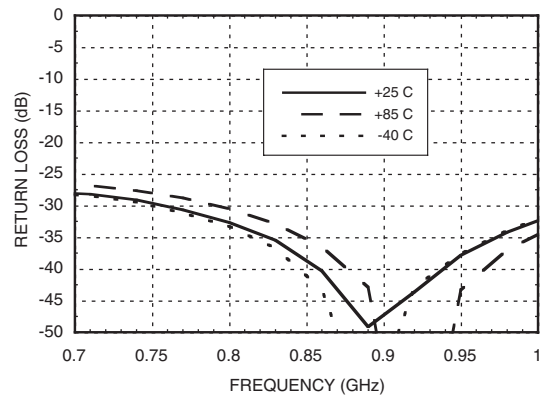

Bypass Mode Output Return Loss vs. Temperature

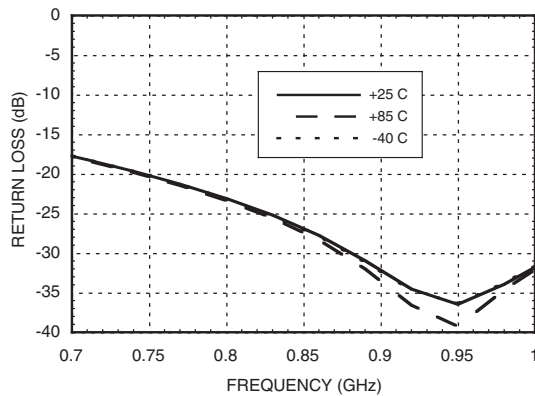

Bypass Mode Input IP3 vs. Temperature

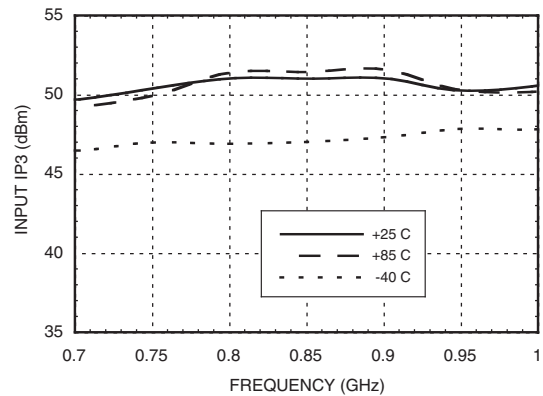

Absolute Maximum Ratings

Drain Bias Voltage (Vdd)	+8.0 Vdc
RF Input Power	LNA Mode +15 dBm
(RFIn)(Vdd = +5.0 Vdc)	Bypass Mode +30 dBm
Channel Temperature	150 °C
Continuous Pdiss (T = 85 °C) (derate 13.5 mW/°C above 85 °C)	0.878 W
Thermal Resistance (channel to ground paddle)	74.1 °C/W
Storage Temperature	-65 to +150° C
Operating Temperature	-40 to +85° C

Typical Supply Current vs. Vdd

Vdd (Vdc)	Idd (mA)
+4.5	87
+5.0	90
+5.5	93

Truth Table

LNA Mode	Vctl= Short Circuit to DC Ground
Bypass Mode	Vctl= Open Circuit

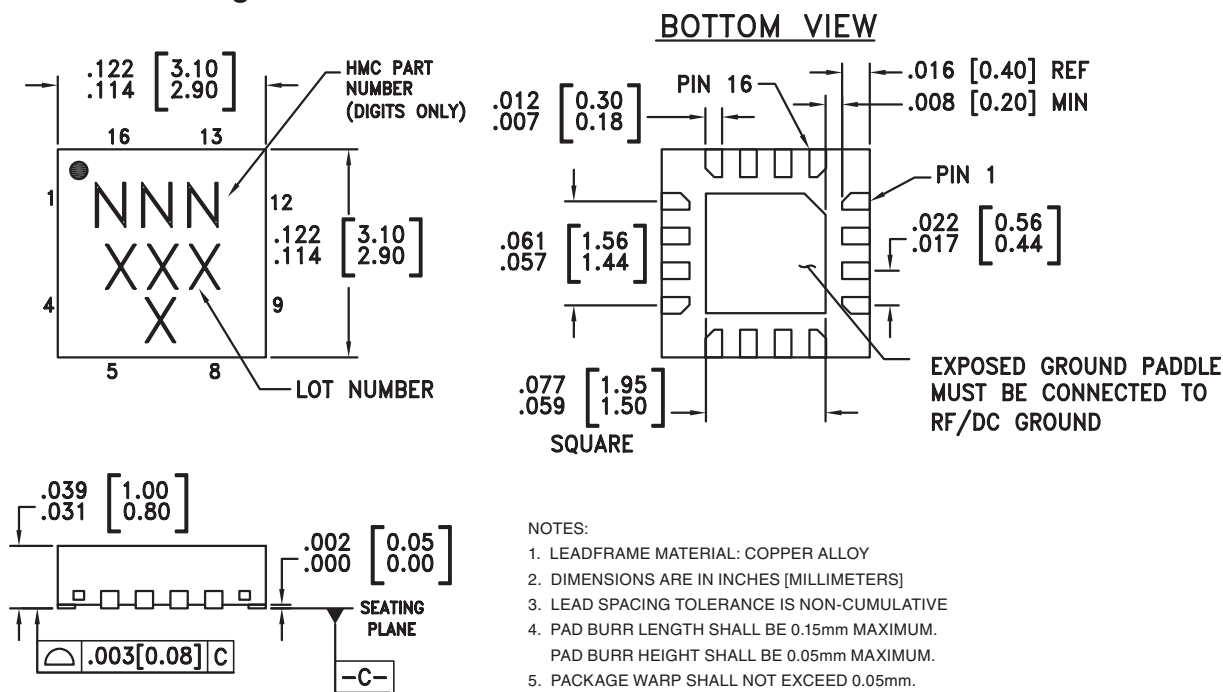

**ELECTROSTATIC SENSITIVE DEVICE
OBSERVE HANDLING PRECAUTIONS**

Outline Drawing

Package Information



Part Number	Package Body Material	Lead Finish	MSL Rating	Package Marking ^[3]
HMC373LP3	Low Stress Injection Molded Plastic	Sn/Pb Solder	MSL1 ^[1]	373 XXXX
HMC373LP3E	RoHS-compliant Low Stress Injection Molded Plastic	100% matte Sn	MSL1 ^[2]	373 XXXX

[1] Max peak reflow temperature of 235 °C

[2] Max peak reflow temperature of 260 °C

[3] 4-Digit lot number XXXX

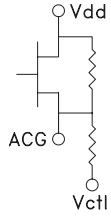
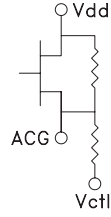
**GaAs PHEMT MMIC LOW NOISE
AMPLIFIER w/ BYPASS MODE, 700 - 1000 MHz**
Pin Descriptions

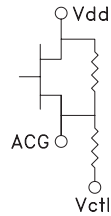
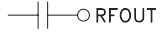
Pin Number	Function	Description	Interface Schematic
1, 3, 5, 8, 10, 12, 13, 15, 16	N/C	No connection necessary. These pins may be connected to RF/DC ground.	
2	RFIN	This pin is matched to 50 Ohms with a 19 nH inductor to ground. See Application Circuit.	RFIN ○ —
4	Vctl	DC ground return. LNA is in high gain mode when a short circuit is introduced to this pin through an external switch. LNA is in bypass mode when open circuit is introduced	
6	ACG	An external capacitor of 0.01μF to ground is required for low frequency bypassing. See Application Circuit for further details.	
7, 14	GND	These pins must be connected to RF/DC ground.	
9	Vdd	Power supply voltage. Choke inductor and bypass capacitor are required. See application circuit.	
11	RFOUT	This pin is AC coupled and matched to 50 Ohms.	

Evaluation PCB

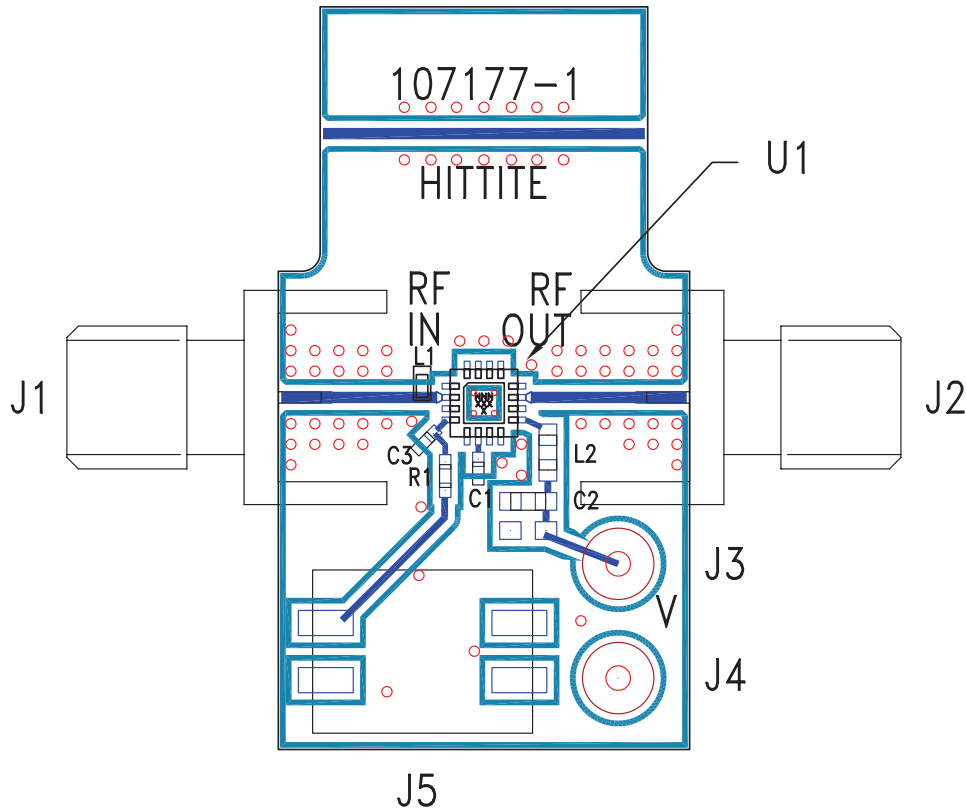

List of Materials for Evaluation PCB 107220 [1]

Item	Description
J1 - J2	PCB Mount SMA RF Connector
J3 - J4	DC Pin
J5	2 Pos DIP Switch
C1	10000 pF Capacitor, 0402 Pkg.
C2	10000 pF Capacitor, 0603 Pkg.
C3	1000 pF Capacitor, 0402 Pkg.
L1	19 nH Inductor, 0402 Pkg.
L2	18 nH Inductor, 0603 Pkg.
R1	2 Ohm Resistor, 0402 Pkg.
U1	HMC373LP3 / HMC373LP3E Amplifier
PCB [2]	107177 Evaluation Board

[1] Reference this number when ordering complete evaluation PCB

[2] Circuit Board Material: Rogers 4350

The circuit board used in the final application should use RF circuit design techniques. Signal lines should have 50 ohm impedance while the package ground leads and exposed paddle should be connected directly to the ground plane similar to that shown. A sufficient number of VIA holes should be used to connect the top and bottom ground planes. The evaluation circuit board shown is available from Hittite upon request.

Evaluation Board Circuit

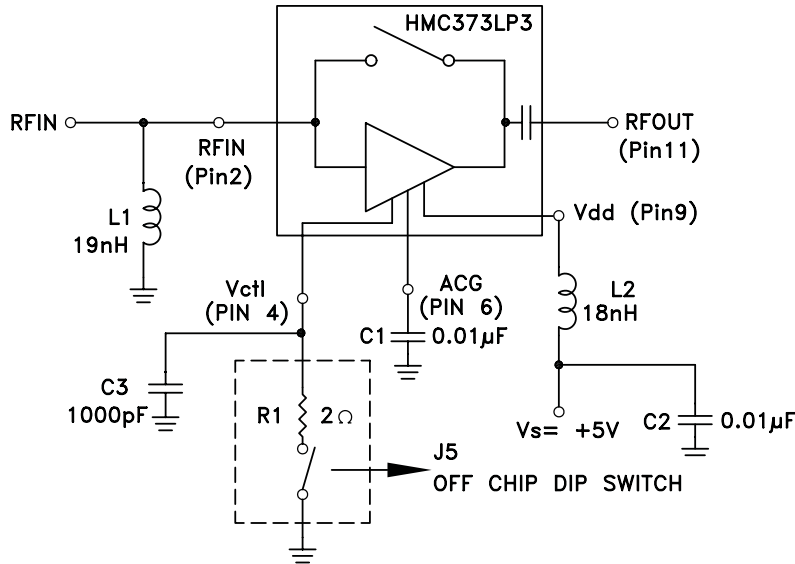

Application Circuit

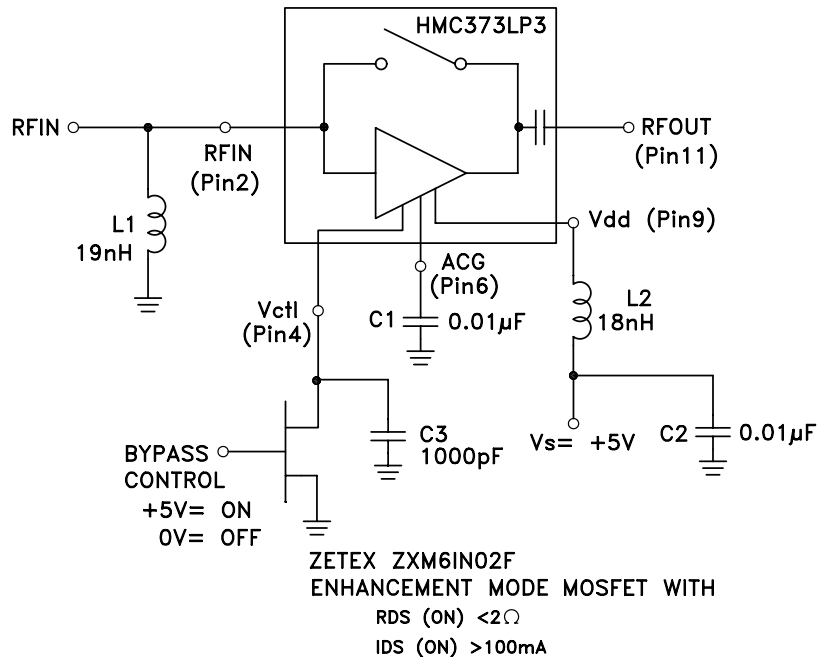

Note 1: Choose value of capacitor C1 for low frequency bypassing. A 0.01 μF $\pm 10\%$ capacitor is recommended.

Note 2: Pin 4 (Vctl) is the DC ground return for the circuit. The LNA is in the high gain mode when a short circuit is introduced to this pin through an external switch. The LNA is in bypass mode when an open circuit is introduced. For the data presented, switching is done through a two position DIP switch (J5) in series with a 2 Ohm resistor (to account for the Ron of an electrical switch).

Note 3: L1, L2 and C1 should be located as close to pins as possible.