

# BRIGHT LED ELECTRONICS

- Device Number : BPI-3C1-09
- Absolute Maximum Rating (Ta=25°C)

Page: 2  
Version: 1.0

Item		Symbol	Rating	Unit
Input	Power Dissipation	Pd	75	mW
	Reverse Voltage	V <sub>R</sub>	5	V
	Forward Current	I <sub>F</sub>	50	mA
	Peak Forward Current (*1)	I <sub>FP</sub>	1	A
Output	Collector Power Dissipation	P <sub>C</sub>	100	mW
	Collector Current	I <sub>C</sub>	20	mA
	C-E Voltage	V <sub>CEO</sub>	30	V
	E-C Voltage	V <sub>ECO</sub>	5	V
Operating Temperature		Topr	-25 ~ +85	°C
Storage Temperature		Tstg	-40 ~ +100	°C
Soldering Temperature (*2)		Tsol	260	°C

(\*1) tw=100 uSec. · T=10 mSec.

(\*2) t=5 Sec

- Electrical Optical Characteristics (Ta=25°C)

Parameter		Symbol	Condition	Min.	Typ.	Max.	Unit
Input	Forward Voltage	V <sub>F</sub>	I <sub>F</sub> =20mA	—	1.2	1.5	V
	Reverse Current	I <sub>R</sub>	V <sub>R</sub> =5V	—	—	10	μA
	Peak Wavelength	λ <sub>p</sub>	I <sub>F</sub> =10mA		940		nm
Output	Dark Current	I <sub>D</sub>	V <sub>CE</sub> =10V	—	—	100	nA
	C-E Saturation Voltage	V <sub>CE(sat)</sub>	I <sub>C</sub> =0.25mA I <sub>F</sub> =10mA	—	—	0.4	V
Light Current		I <sub>L</sub>	V <sub>CE</sub> =5V I <sub>F</sub> =10mA	0.5	—	5	mA
Speed	Rise Time	Tr	I <sub>FP</sub> =20mA V <sub>CE</sub> =5V	—	15	—	μsec
	Fall Time	Tf	R <sub>L</sub> =1000Ω	—	20	—	μsec

# BRIGHT LED ELECTRONICS

- Device Number : BPI-3C1-09
- Package Dimensions

Page: 3  
Version: 1.0

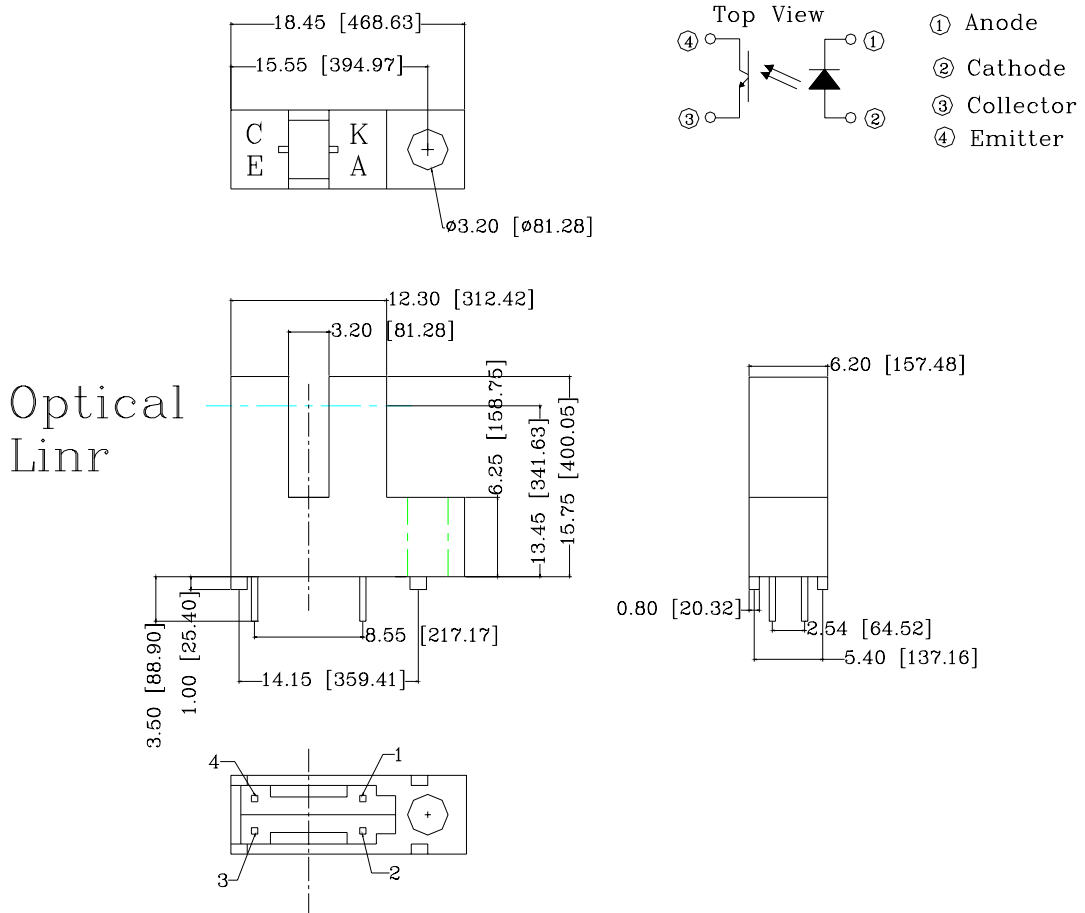

## Notes:

1. All dimensions are in millimeters (inches).
2. Tolerance is  $\pm 0.25\text{mm}$  unless otherwise specified.
3. Lead spacing is measured where the leads emerge from the package.
4. Specifications are subject to change without notice.

# BRIGHT LED ELECTRONICS

- Device Number : BPI-3C1-09
- Typical Electrical / Optical Characteristics Curves (Ta=25°C)

Page: 4  
Version: 1.0

Fig.1 Power Dissipation vs. Ambient Temperature

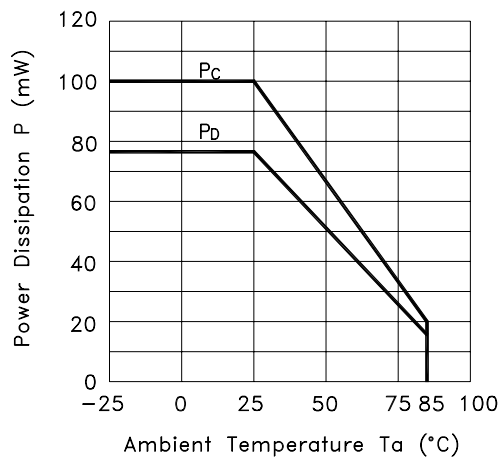

Fig.2 Forward Current vs. Forward Voltage

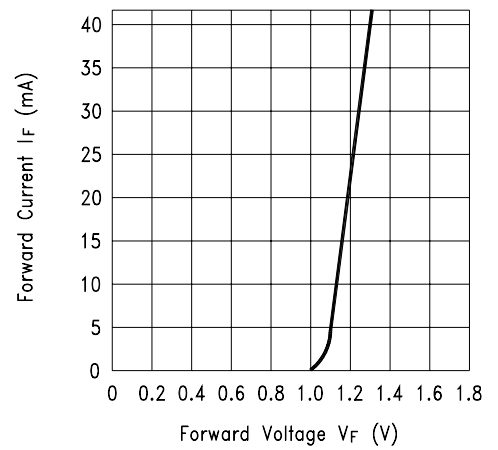

Fig.3 Collector Current vs. Collector-emitter Voltage

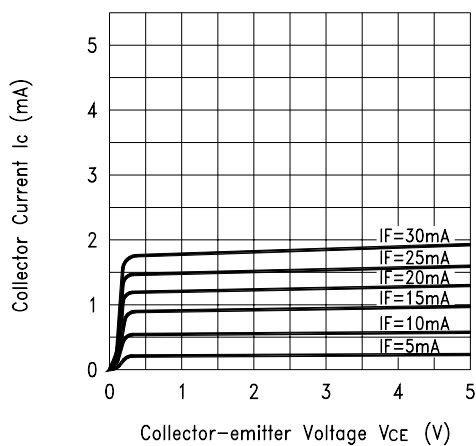
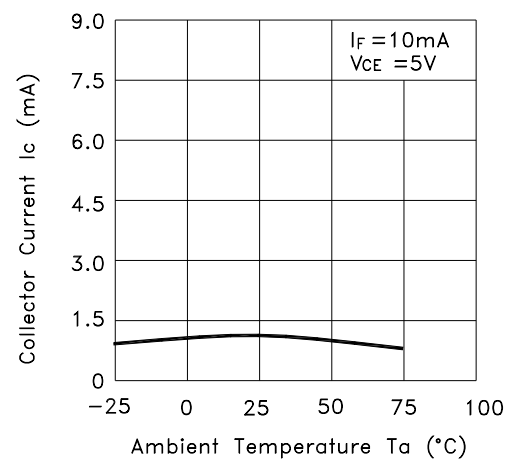

Fig.4 Collector Current vs. Ambient Temperature



# BRIGHT LED ELECTRONICS

- Device Number : BPI-3C1-09
- Typical Electric / Optical Characteristics Curves (Ta=25°C)

Page: 5  
Version: 1.0

Fig.5 Collector-emitter Saturation Voltage vs. Ambient Temperature

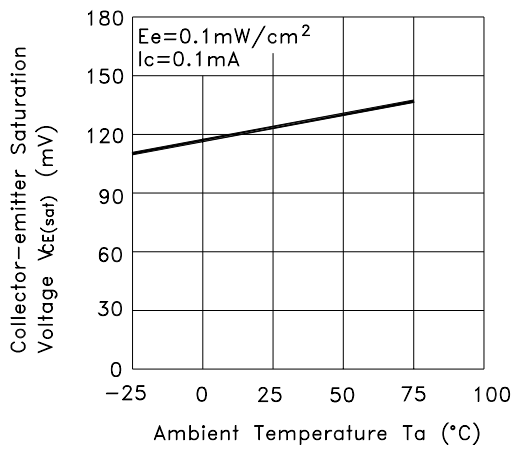

Fig.6 Response Time vs. Load Resistance

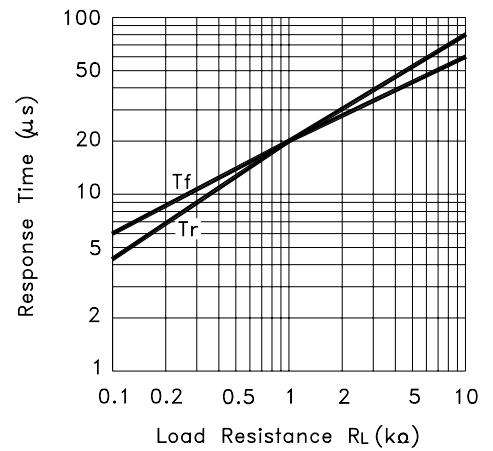
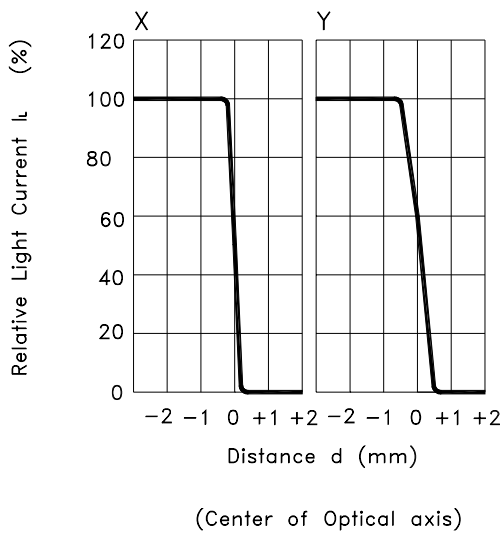
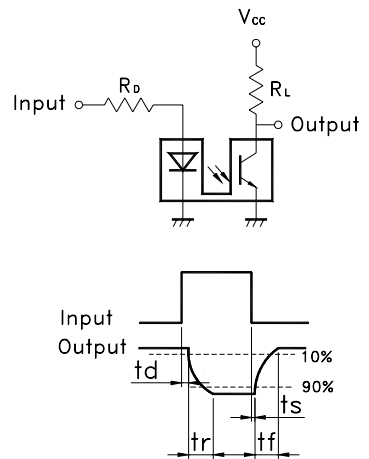

Fig.7 Sensing Position Characteristics (Typical)



Test Circuit for Response Time



# BRIGHT LED ELECTRONICS

- Device Number : BPI-3C1-09
- Packaging Box Dimensions

Page: 6  
Revision: 1.0

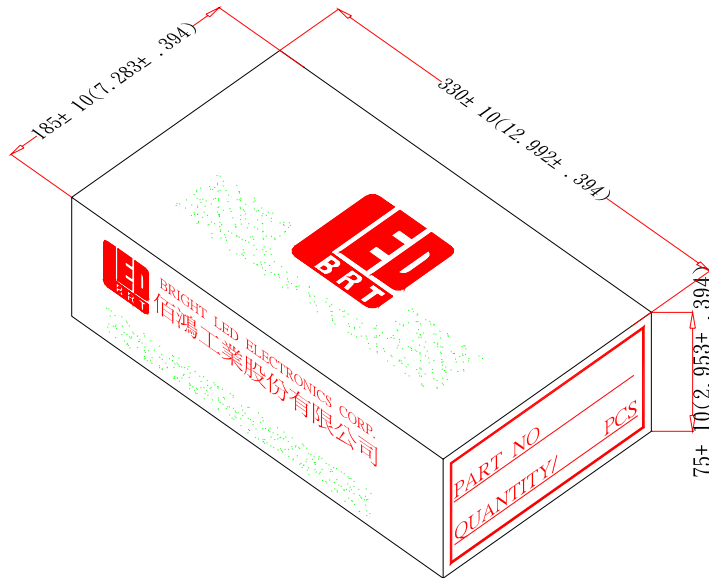

- Packaging Bag Dimensions

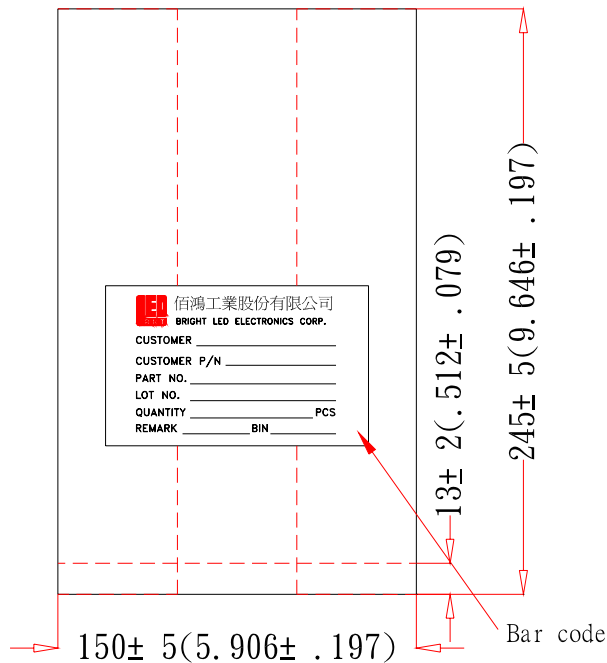

## Notes:

1. 250pcs per bag, 1kpcs per box.
2. All Dimensions are in millimeters (inches).
3. Specifications are subject to change without notice.