



BRIGHT LED ELECTRONICS CORP.

Total Page: 6
Page: 1
Revision: 2.0

- Customer P/N:
- Device Number : BPI-3C1-05
- Features:
 - Non-contact switching.
 - For direct PC board or dual-in-line socket mounting.
 - Fast switching speed.
 - This product doesn't contain restriction substance, comply ROHS standard.

Sheet Date	1	2	3	4	5	6	Contents
2001.12.20	1.0	1.0	1.0	1.0	1.0	1.0	Initial Released
2002.01.08	1.1	1.0	1.1	1.0	1.0	1.1	Packaging Dimensions: Pin Length: 9.12mm→3.5mm 2. Packaging Bag Dimensions
2002.03.21	1.2	1.1	1.1	1.0	1.0	1.1	Light Current: IL: max 10Ma→5Ma
2002.12.12	1.3	1.0	1.2	1.1	1.0	1.2	Packaging Dimensions: Slit Width 1.1mm→0.4mm 2. Packaging Bag Dimensions
2004.10.26	1.4	--	-	-	-	-	Features
2004.11.26	2.0	1.0	1.2	1.1	1.0	1.3	Packaging

Total Page	6																		
------------	---	--	--	--	--	--	--	--	--	--	--	--	--	--	--	--	--	--	--

佰鴻工業股份有限公司

BRIGHT LED ELECTRONICS CORP.

台北縣板橋市和平路 19 號 3 樓
3F., No. 19, Ho Ping Road, Pan Chiao City,
Taipei, Taiwan, R. O. C.
Tel: 886-2-29591090
Fax: 886-2-29547006/29558809

www.brtled.com

廣東省東莞市高步鎮蘆溪管理區高龍東路號
No.8 Gaolong eastwayLuxiprecinctGaobu
Town Dongguan city Guangdong Province
China

Tel : 886-0769-8730255 8731855

Fax : 886-0769-8733355 8738706

www.brtled.com

Approved	Checked	Drawn
 郝 2004.11.26 志群	 郝 2004.11.26 志群	 彭 2004.11.26 洁

BRIGHT LED ELECTRONICS

- Device Number : BPI-3C1-05
- Absolute Maximum Rating (Ta=25°C)

Page: 2
Version: 1.1

Item		Symbol	Rating	Unit
Input	Power Dissipation	Pd	75	mW
	Reverse Voltage	V _R	5	V
	Forward Current	I _F	50	mA
	Peak Forward Current (*1)	I _{FP}	1	A
Output	Collector Power Dissipation	P _C	100	mW
	Collector Current	I _C	40	mA
	C-E Voltage	V _{CEO}	30	V
	E-C Voltage	V _{ECO}	5	V
Operating Temperature		Topr	-25 ~ +85	°C
Storage Temperature		Tstg	-40 ~ +100	°C
Soldering Temperature (*2)		Tsol	260	°C

(*1) tw=100 uSec. · T=10 mSec.

(*2) t=5 Sec

- Electrical Optical Characteristics (Ta=25°C)

Parameter		Symbol	Condition	Min.	Typ.	Max.	Unit
Input	Forward Voltage	V _F	I _F =20mA	—	1.2	1.5	V
	Reverse Current	I _R	V _R =5V	—	—	100	μA
	Peak Wavelength	λ _p	I _F =10mA		940		nm
Output	Dark Current	I _D	V _{CE} =10V	—	—	100	nA
	C-E Saturation Voltage	V _{CE(sat)}	I _C =0.25mA I _F =10mA	—	—	0.4	V
Light Current		I _L	V _{CE} =5V I _F =10mA	0.5	—	5.0	mA
Speed	Rise Time	Tr	I _{FP} =20mA V _{CE} =5V	—	20	—	μsec
	Fall Time	Tf	R _L =1000Ω	—	20	—	μsec

BRIGHT LED ELECTRONICS

- Device Number : BPI-3C1-05
- Package Dimensions

Page: 3
Version: 1.2

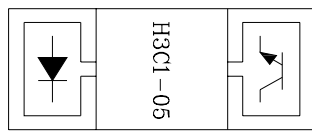

Top View

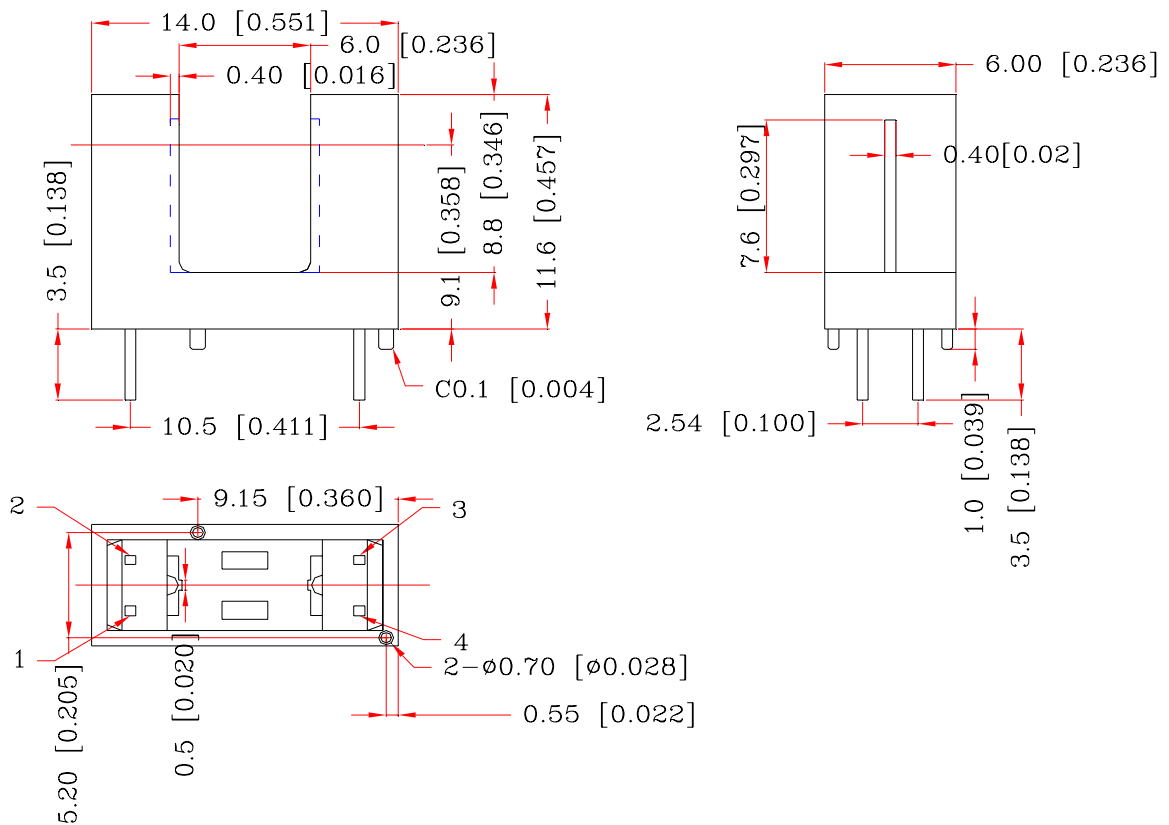
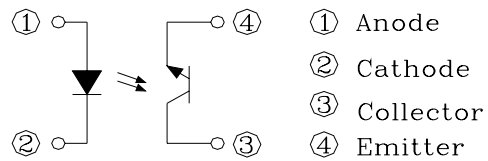

Notes:

1. All dimensions are in millimeters (inches).
2. Tolerance is ± 0.25 mm unless otherwise specified.
3. Lead spacing is measured where the leads emerge from the package.
4. Specifications are subject to change without notice.

BRIGHT LED ELECTRONICS

- Device Number : BPI-3C1-05
- Typical Electrical / Optical Characteristics Curves (Ta=25°C)

Page: 4
Version: 1.0

Fig.1 Power Dissipation vs. Ambient Temperature

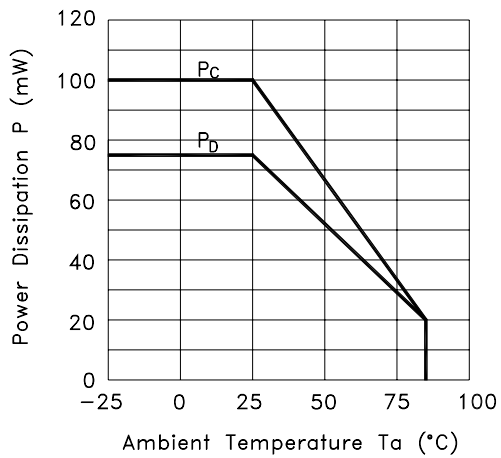

Fig.2 Forward Current vs. Forward Voltage

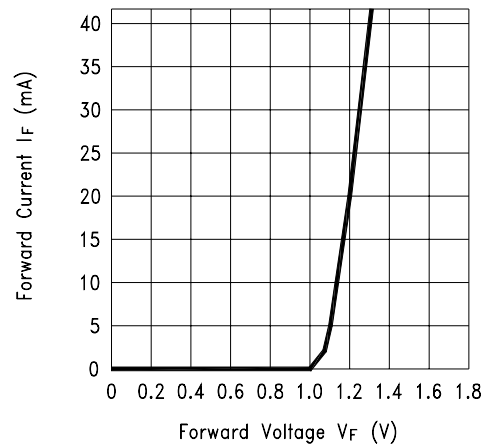

Fig.3 Collector Current vs. Collector-emitter Voltage

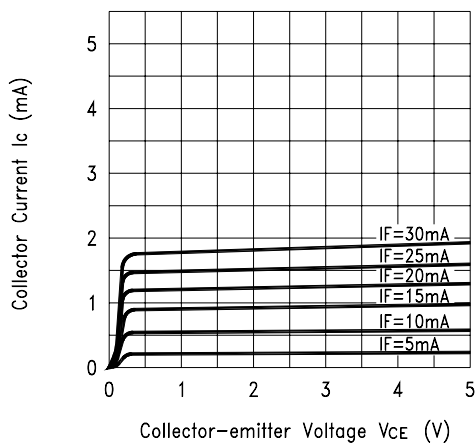
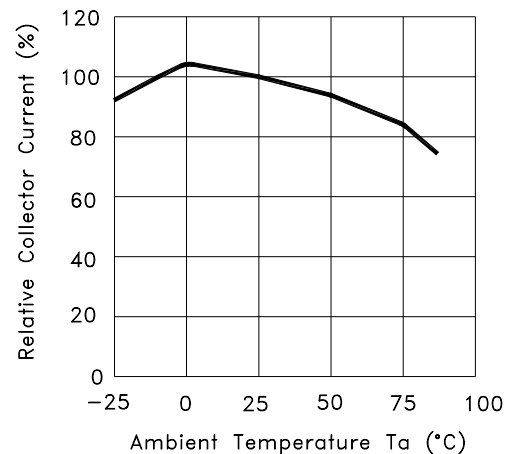

Fig.4 Collector Current vs. Ambient Temperature



BRIGHT LED ELECTRONICS

- Device Number : BPI-3C1-05
- Typical Electric / Optical Characteristics Curves ($T_a=25^\circ\text{C}$)

Page: 5
Version: 1.0

Fig.5 Collector-emitter Saturation Voltage vs. Ambient Temperature

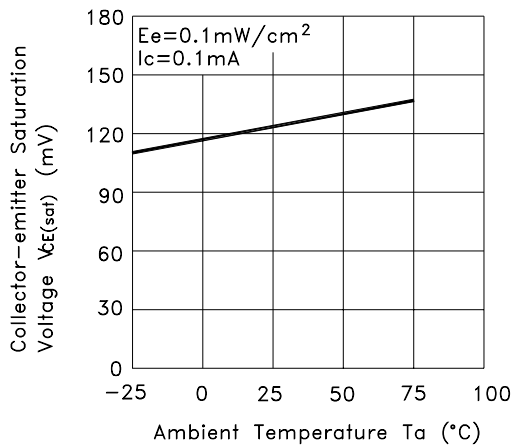

Fig.6 Response Time vs. Load Resistance

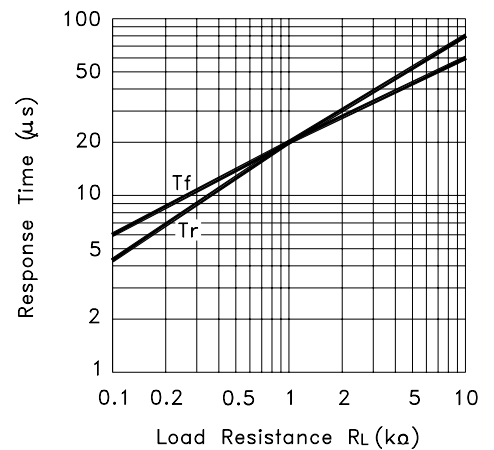
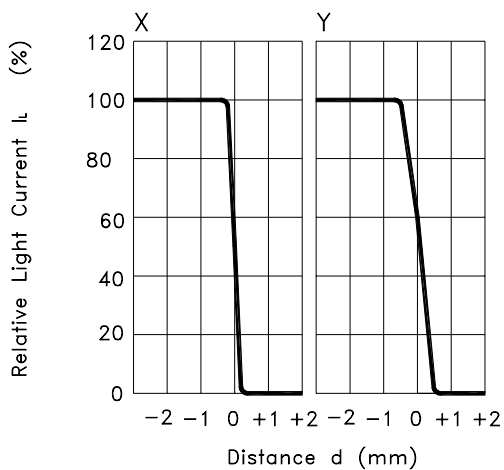
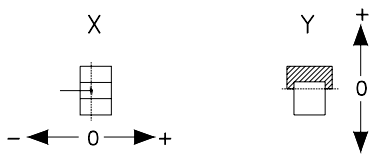

Fig.7 Sensing Position Characteristics (Typical)



(Center of Optical axis)



Test Circuit for Response Time

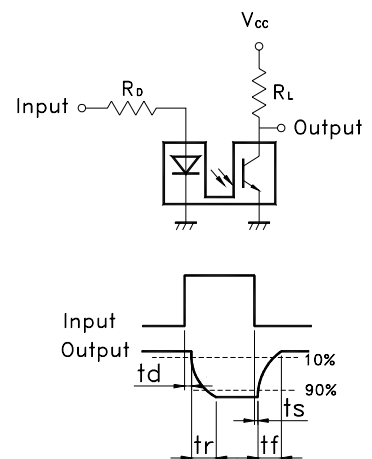

BRIGHT LED ELECTRONICS

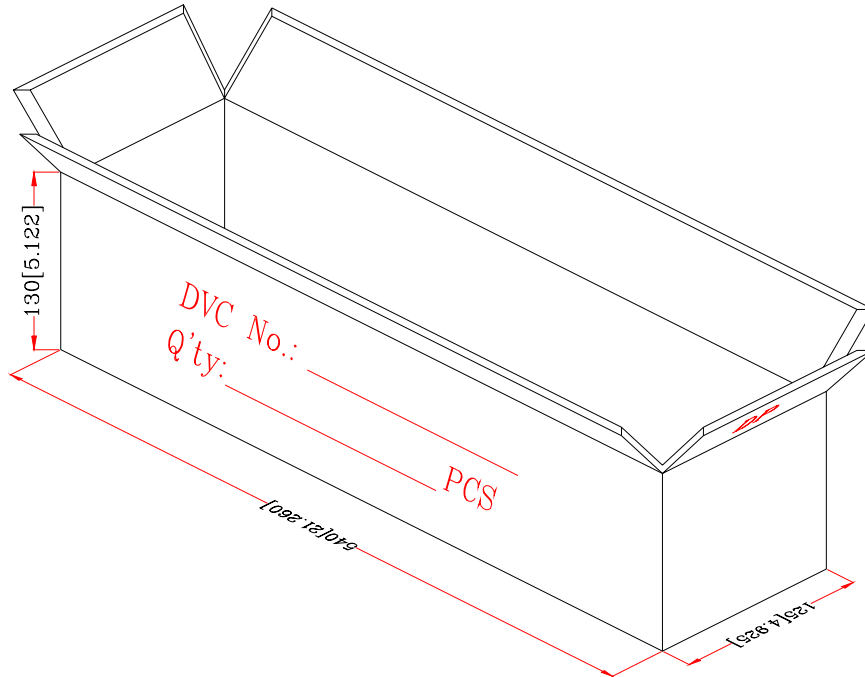

- Device Number : BPI-3C1-05
- Packaging Box Dimensions

Page: 6
Version: 1.3

- Packaging Tube Dimensions

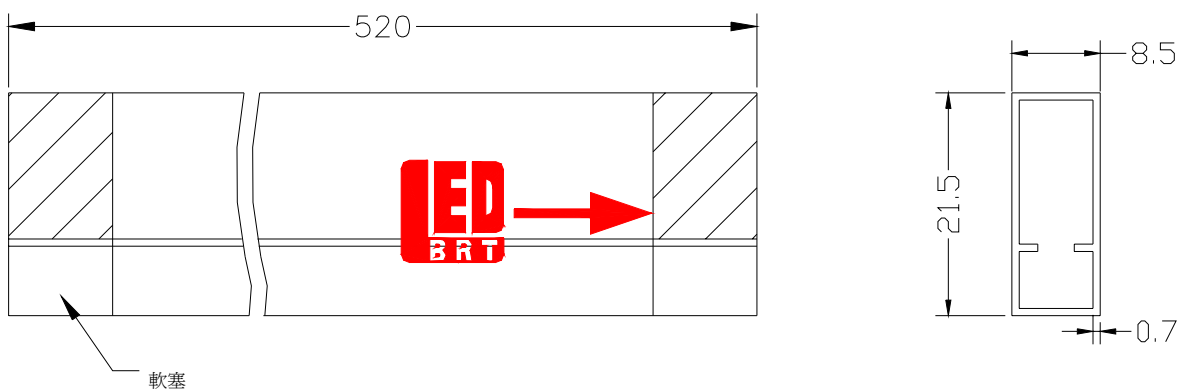

Notes:

1. 35pcs per tube, 2.73kpcs per box.
2. All Dimensions are in millimeters (inches).
3. Specifications are subject to change without notice.