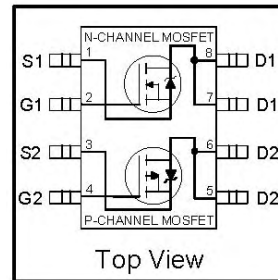


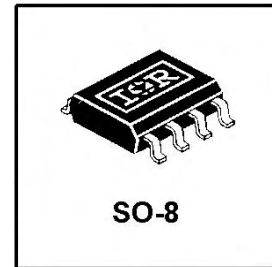
# IRF7309IPbF

## HEXFET® Power MOSFET

- Generation V Technology
- Ultra Low On-Resistance
- Dual N and P Channel Mosfet
- Surface Mount
- Available in Tape & Reel
- Dynamic dv/dt Rating
- Fast Switching
- Lead-Free



	N-Ch	P-Ch
$V_{DS}$	30V	-30V
$R_{DS(on)}$	0.050Ω	0.10Ω



### Description

Fifth Generation HEXFETs from International Rectifier utilize advanced processing techniques to achieve the lowest possible on-resistance per silicon area. This benefit, combined with the fast switching speed and ruggedized device design for which HEXFET Power MOSFETs are well known, provides the designer with an extremely efficient device for use in a wide variety of applications.

The SO-8 has been modified through a customized leadframe for enhanced thermal characteristics and multiple-die capability making it ideal in a variety of power applications. With these improvements, multiple devices can be used in an application with dramatically reduced board space. The package is designed for vapor phase, infra-red, or wave soldering techniques. Power dissipation of greater than 0.8W is possible in a typical PCB mount application.

### Absolute Maximum Ratings

Parameter		Max.		Units
		N-Channel	P-Channel	
$I_D @ T_A = 25^\circ\text{C}$	10 Sec. Pulse Drain Current, $V_{GS} @ 10\text{V}$	4.7	-3.5	A
$I_D @ T_A = 25^\circ\text{C}$	Continuous Drain Current, $V_{GS} @ 10\text{V}$	4.0	-3.0	A
$I_D @ T_A = 70^\circ\text{C}$	Continuous Drain Current, $V_{GS} @ 10\text{V}$	3.2	-2.4	A
$I_{DM}$	Pulsed Drain Current $\Phi$	16	-12	A
$P_D @ T_A = 25^\circ\text{C}$	Power Dissipation (PCB Mount)**	1.4		W
	Linear Derating Factor (PCB Mount)**	0.011		W/°C
$V_{GS}$	Gate-to-Source Voltage	± 20		V
dv/dt	Peak Diode Recovery dv/dt $\Phi$	6.9	-6.0	V/ns
$T_J, T_{STG}$	Junction and Storage Temperature Range	-55 to + 150		°C

### Thermal Resistance

	Parameter	Min.	Typ.	Max.	Units
$R_{\theta JA}$	Junction-to-Amb. (PCB Mount, steady state)**	—	—	90	°C/W

\*\* When mounted on 1" square PCB (FR-4 or G-10 Material).

For recommended footprint and soldering techniques refer to application note #AN-994.

## Electrical Characteristics @ $T_J = 25^\circ\text{C}$ (unless otherwise specified)

Parameter	Parameter		Min.	Typ.	Max.	Units	Conditions	
$V_{(BR)DSS}$	Drain-to-Source Breakdown Voltage	N-Ch	30	—	—	V	$V_{GS} = 0V, I_D = 250\mu A$	
		P-Ch	-30	—	—		$V_{GS} = 0V, I_D = -250\mu A$	
$\Delta V_{(BR)DSS}/\Delta T_J$	Breakdown Voltage Temp. Coefficient	N-Ch	—	0.032	—	$V/^\circ C$	Reference to $25^\circ C, I_D = 1mA$	
		P-Ch	—	0.037	—		Reference to $25^\circ C, I_D = -1mA$	
$R_{DS(ON)}$	Static Drain-to-Source On-Resistance	N-Ch	—	—	0.050	$\Omega$	$V_{GS} = 10V, I_D = 2.4A$ ①	
		N-Ch	—	—	0.080		$V_{GS} = 4.5V, I_D = 2.0A$ ②	
		P-Ch	—	—	0.10		$V_{GS} = -10V, I_D = -1.8A$ ③	
		P-Ch	—	—	0.16		$V_{GS} = -4.5V, I_D = -1.5A$ ③	
$V_{GS(th)}$	Gate Threshold Voltage	N-Ch	1.0	—	—	V	$V_{DS} = V_{GS}, I_D = 250\mu A$	
		P-Ch	-1.0	—	—		$V_{DS} = V_{GS}, I_D = -250\mu A$	
$g_{fs}$	Forward Transconductance	N-Ch	5.2	—	—	S	$V_{DS} = 15V, I_D = 2.4A$ ①	
		P-Ch	2.5	—	—		$V_{DS} = -24V, I_D = -1.8A$ ③	
$I_{DSS}$	Drain-to-Source Leakage Current	N-Ch	—	—	1.0	$\mu A$	$V_{DS} = 24V, V_{GS} = 0V$	
		P-Ch	—	—	-1.0		$V_{DS} = -24V, V_{GS} = 0V$	
		N-Ch	—	—	25		$V_{DS} = 24V, V_{GS} = 0V, T_J = 125^\circ C$	
		P-Ch	—	—	-25		$V_{DS} = -24V, V_{GS} = 0V, T_J = 125^\circ C$	
$I_{GSS}$	Gate-to-Source Forward Leakage	N-P	—	—	$\pm 100$		$V_{GS} = \pm 20V$	
$Q_g$	Total Gate Charge	N-Ch	—	—	25		N-Channel $I_D = 2.6A, V_{DS} = 16V, V_{GS} = 4.5V$	③
		P-Ch	—	—	25			
$Q_{gs}$	Gate-to-Source Charge	N-Ch	—	—	2.9	$nC$	P-Channel $I_D = -2.2A, V_{DS} = -16V, V_{GS} = -4.5V$	③
		P-Ch	—	—	2.9			
$Q_{gd}$	Gate-to-Drain ("Miller") Charge	N-Ch	—	—	7.9			③
		P-Ch	—	—	9.0			
$t_{d(on)}$	Turn-On Delay Time	N-Ch	—	6.8	—		N-Channel $V_{DD} = 10V, I_D = 2.6A, R_G = 6.0\Omega, R_D = 3.8\Omega$	③
		P-Ch	—	11	—			
$t_r$	Rise Time	N-Ch	—	21	—		P-Channel $V_{DD} = -10V, I_D = -2.2A, R_G = 6.0\Omega, R_D = 4.5\Omega$	③
		P-Ch	—	17	—			
$t_{d(off)}$	Turn-Off Delay Time	N-Ch	—	22	—			③
		P-Ch	—	25	—			
$t_f$	Fall Time	N-Ch	—	7.7	—			③
		P-Ch	—	18	—			
$L_D$	Internal Drain Inductance	N-P	—	4.0	—		Between lead tip and center of die contact	
$L_S$	Internal Source Inductance	N-P	—	6.0	—			
$C_{iss}$	Input Capacitance	N-Ch	—	520	—		N-Channel $V_{GS} = 0V, V_{DS} = 15V, f = 1.0MHz$	③
		P-Ch	—	440	—			
$C_{oss}$	Output Capacitance	N-Ch	—	180	—	$pF$	P-Channel $V_{GS} = 0V, V_{DS} = -15V, f = 1.0MHz$	③
		P-Ch	—	200	—			
$C_{rss}$	Reverse Transfer Capacitance	N-Ch	—	72	—			③
		P-Ch	—	93	—			

## Source-Drain Ratings and Characteristics

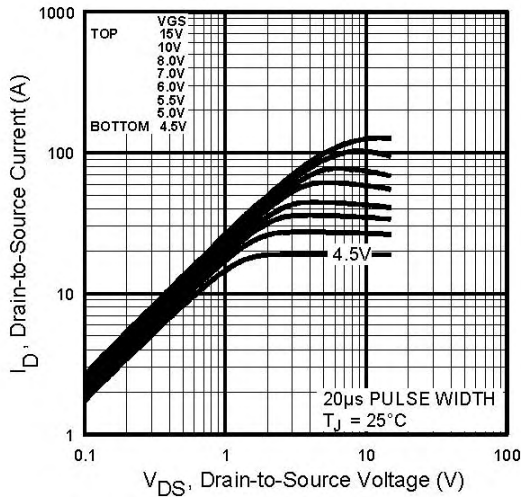
Parameter	Parameter		Min.	Typ.	Max.	Units	Conditions	
$I_S$	Continuous Source Current (Body Diode)	N-Ch	—	—	1.8	A		
		P-Ch	—	—	-1.8			
$I_{SM}$	Pulsed Source Current (Body Diode) ①	N-Ch	—	—	16			
		P-Ch	—	—	-12			
$V_{SD}$	Diode Forward Voltage	N-Ch	—	—	1.0	V	$T_J = 25^\circ C, I_S = 1.8A, V_{GS} = 0V$ ③	
		P-Ch	—	—	-1.0		$T_J = 25^\circ C, I_S = -1.8A, V_{GS} = 0V$ ③	
$t_{rr}$	Reverse Recovery Time	N-Ch	—	47	71	ns	N-Channel $T_J = 25^\circ C, I_F = 2.6A, di/dt = 100A/\mu s$	③
		P-Ch	—	53	80			
$Q_{rr}$	Reverse Recovery Charge	N-Ch	—	56	84	$nC$		③
		P-Ch	—	66	99			
$t_{on}$	Forward Turn-On Time	N-P	Intrinsic turn-on time is negligible (turn-on is dominated by $L_S + L_D$ )					

① Repetitive rating; pulse width limited by max. junction temperature. ( See fig. 23 )

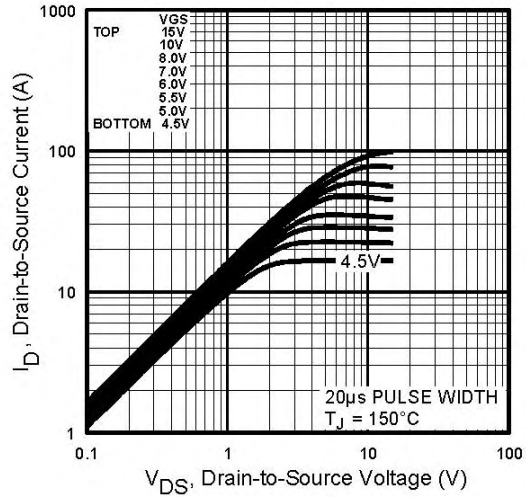
② N-Channel  $I_{SD} \leq 2.4A, di/dt \leq 73A/\mu s, V_{DD} \leq V_{(BR)DSS}, T_J \leq 150^\circ C$   
P-Channel  $I_{SD} \leq -1.8A, di/dt \leq 90A/\mu s, V_{DD} \leq V_{(BR)DSS}, T_J \leq 150^\circ C$

③ Pulse width  $\leq 300\mu s$ ; duty cycle  $\leq 2\%$ .

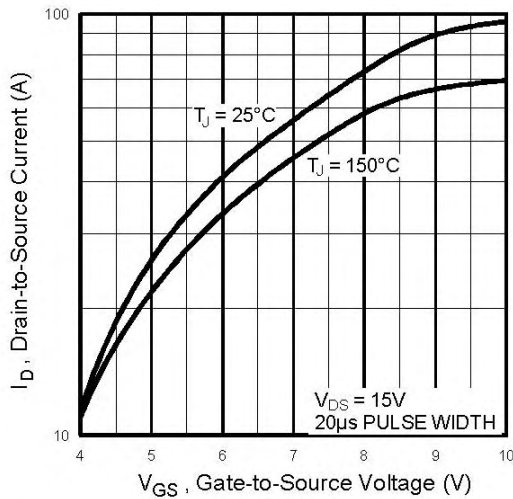
## N-Channel



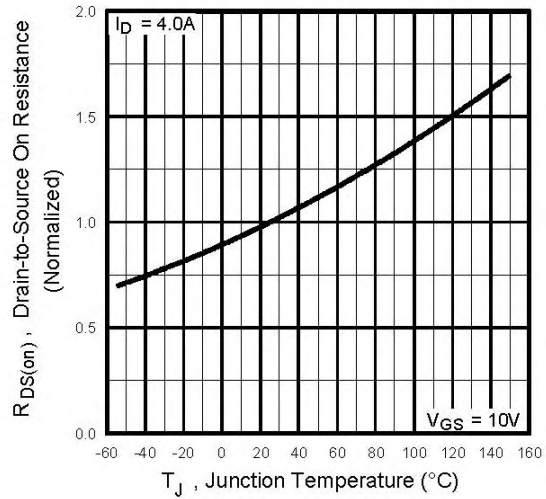
**Fig 1.** Typical Output Characteristics,  
 $T_J = 25^\circ\text{C}$



**Fig 2.** Typical Output Characteristics,  
 $T_J = 150^\circ\text{C}$

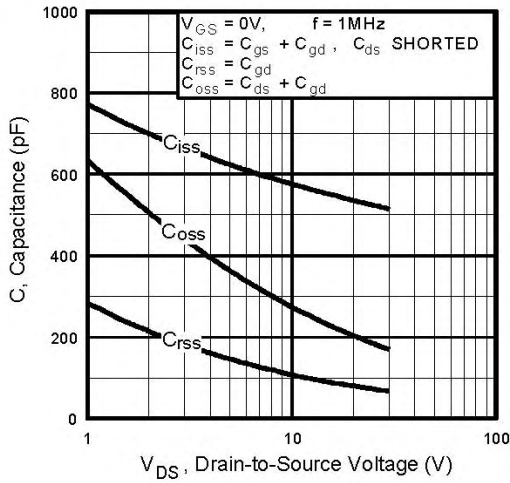


**Fig 3.** Typical Transfer Characteristics

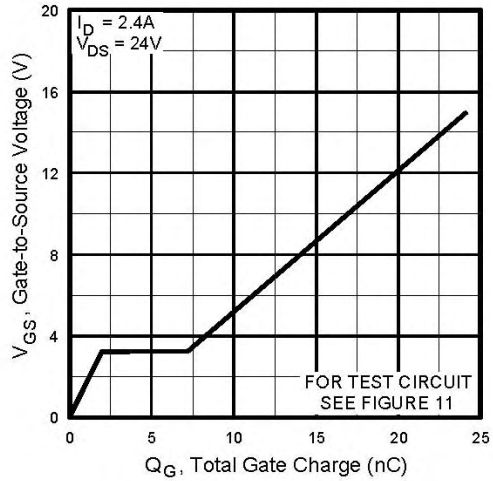


**Fig 4.** Normalized On-Resistance  
Vs. Temperature

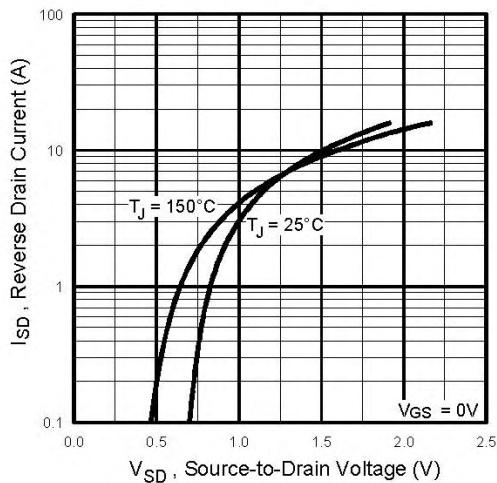
## N-Channel



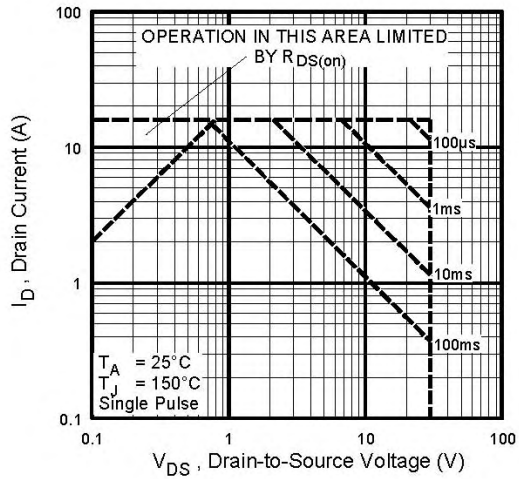
**Fig 5.** Typical Capacitance Vs. Drain-to-Source Voltage



**Fig 6.** Typical Gate Charge Vs. Gate-to-Source Voltage

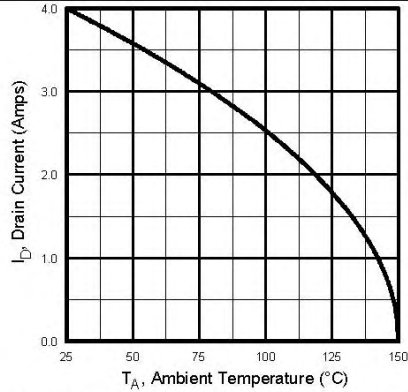


**Fig 7.** Typical Source-Drain Diode Forward Voltage

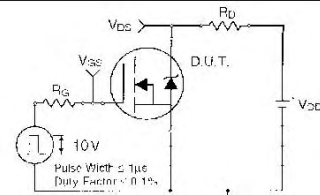


**Fig 8.** Maximum Safe Operating Area

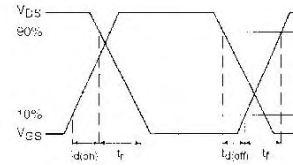
## N-Channel



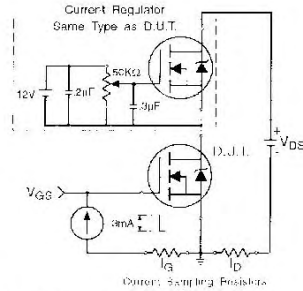
**Fig 9.** Max. Drain Current Vs. Ambient Temp.



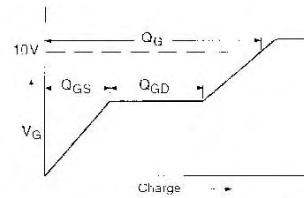
**Fig 10a.** Switching Time Test Circuit



**Fig 10b.** Switching Time Waveforms

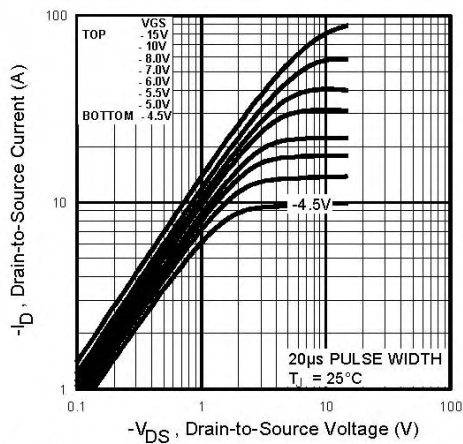


**Fig 11a.** Gate Charge Test Circuit

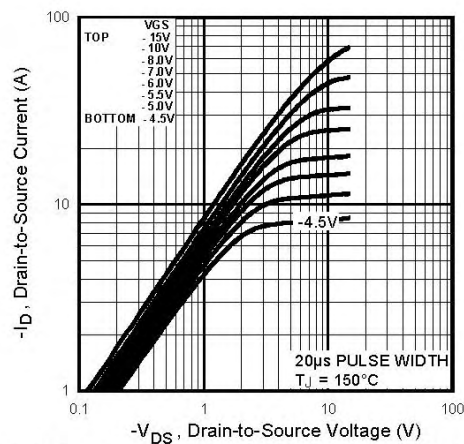


**Fig 11b.** Basic Gate Charge Waveform

## P-Channel

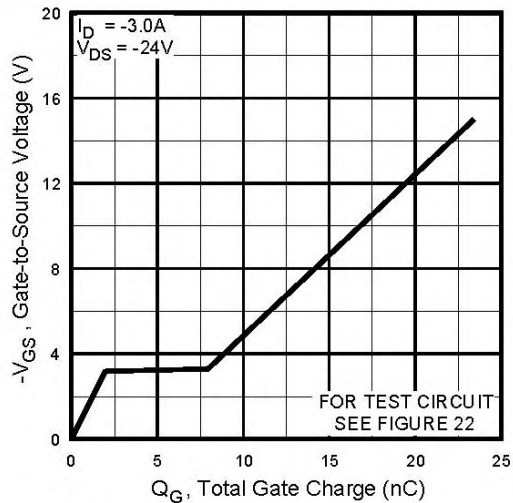
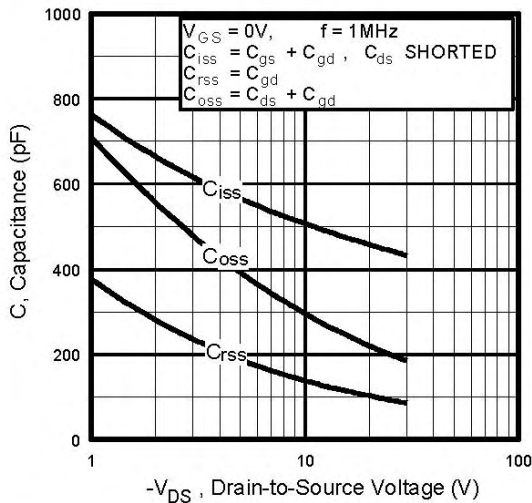
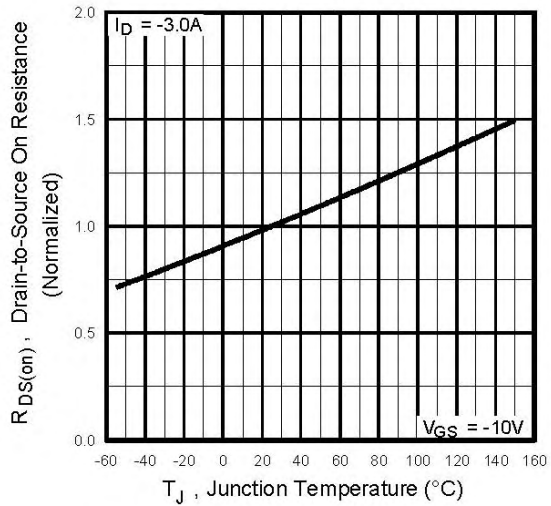
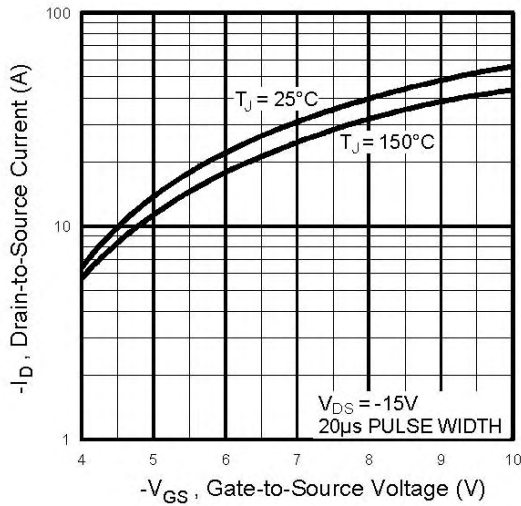


**Fig 12.** Typical Output Characteristics,  $T_J = 25^\circ C$

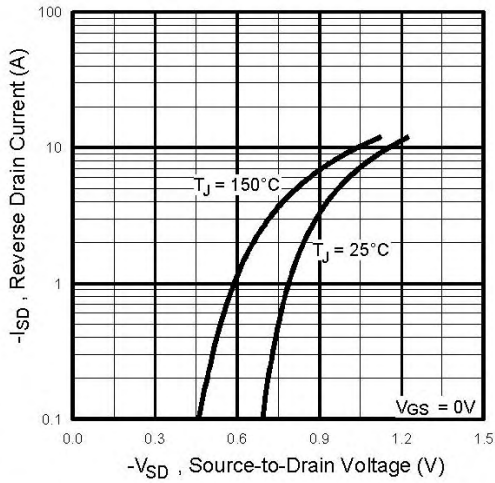


**Fig 13.** Typical Output Characteristics,  $T_J = 150^\circ C$

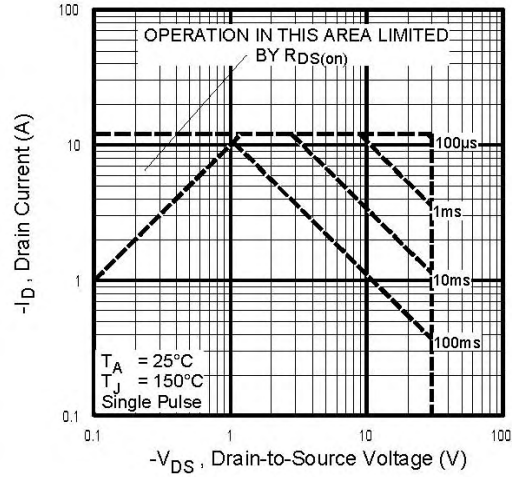
## P-Channel



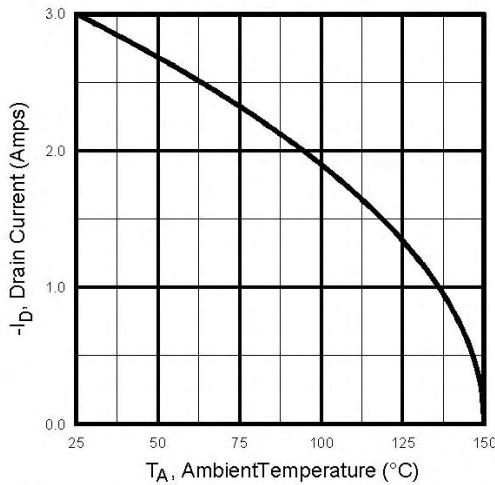
**P-Channel**



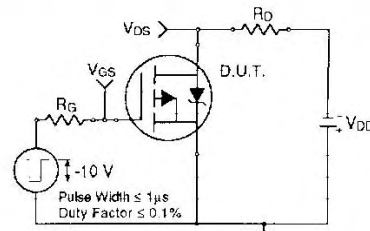
**Fig 18.** Typical Source-Drain Diode Forward Voltage



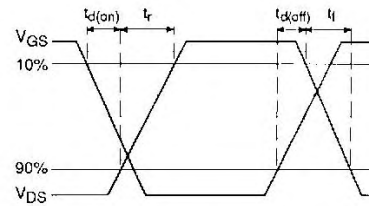
**Fig 19.** Maximum Safe Operating Area



**Fig 20.** Max. Drain Current Vs. Ambient Temp.

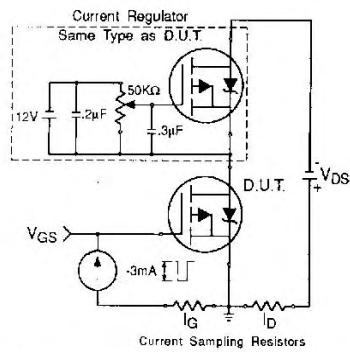


**Fig 21a.** Switching Time Test Circuit

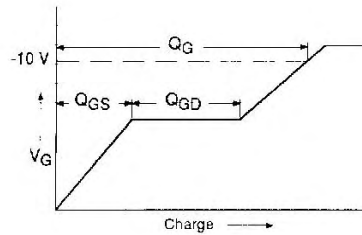


**Fig 21b.** Switching Time Waveforms

## P-Channel

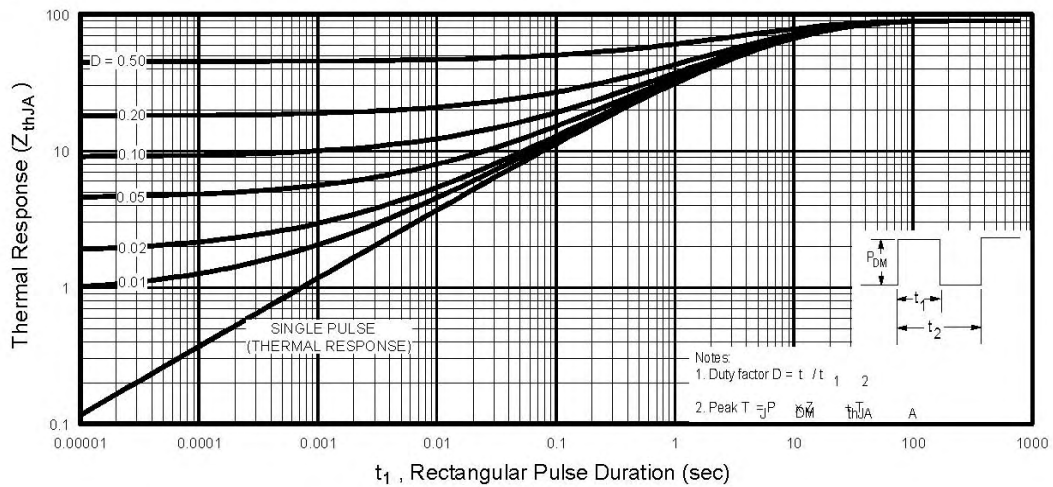


**Fig 22b.** Gate Charge Test Circuit



**Fig 22b.** Basic Gate Charge Waveform

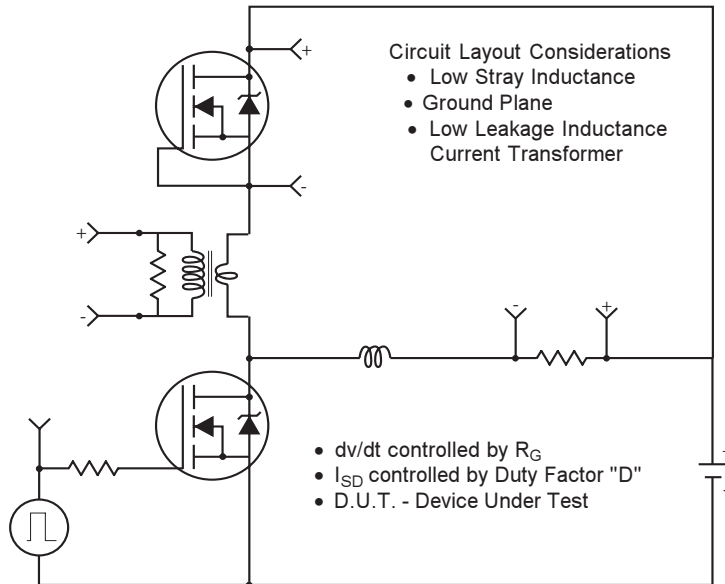
## N- and P-Channel



**Fig 23.** Maximum Effective Transient Thermal Impedance, Junction-to-Ambient

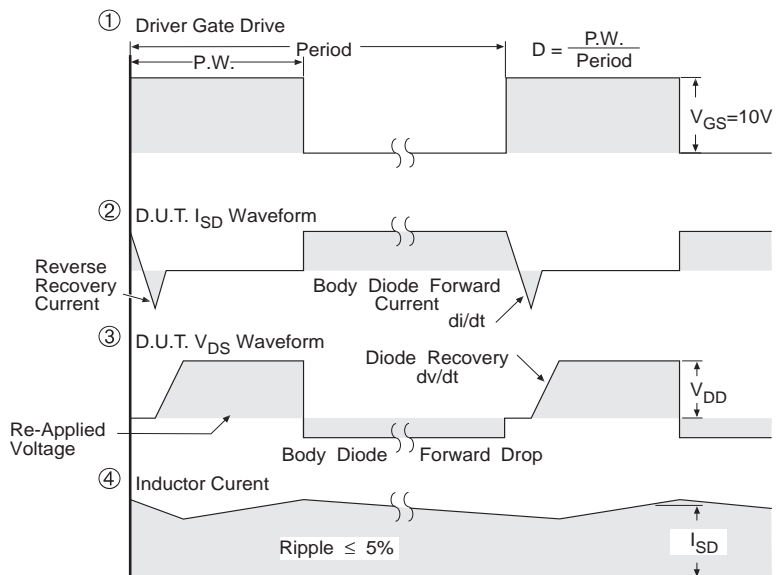


## Peak Diode Recovery dv/dt Test Circuit



\* Reverse Polarity for P-Channel

\*\* Use P-Channel Driver for P-Channel Measurements



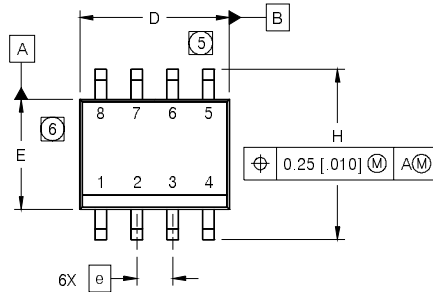
\*\*\*  $V_{GS} = 5.0V$  for Logic Level and  $3V$  Drive Devices

**Fig 24** For N and P Channel HEXFETS

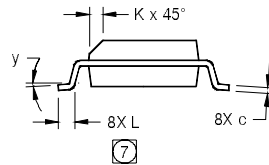
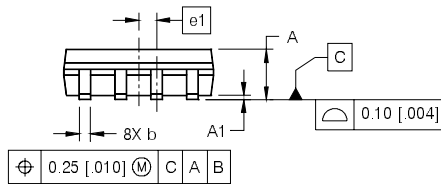
# IRF7309IPbF

## SO-8 Package Outline

Dimensions are shown in millimeters (inches)

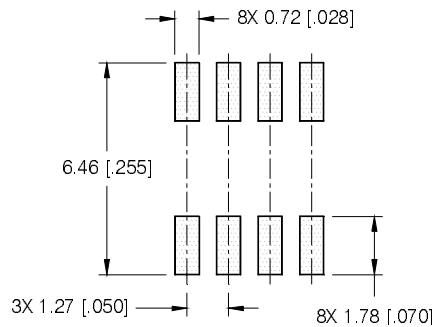


DIM	INCHES		MILLIMETERS	
	MIN	MAX	MIN	MAX
A	.0532	.0688	1.35	1.75
A1	.0040	.0098	0.10	0.25
b	.013	.020	0.33	0.51
c	.0075	.0098	0.19	0.25
D	.189	.1968	4.80	5.00
E	.1497	.1574	3.80	4.00
e	.050 BASIC		1.27 BASIC	
e 1	.025 BASIC		0.635 BASIC	
H	.2284	.2440	5.80	6.20
K	.0099	.0196	0.25	0.50
L	.016	.050	0.40	1.27
y	0°	8°	0°	8°



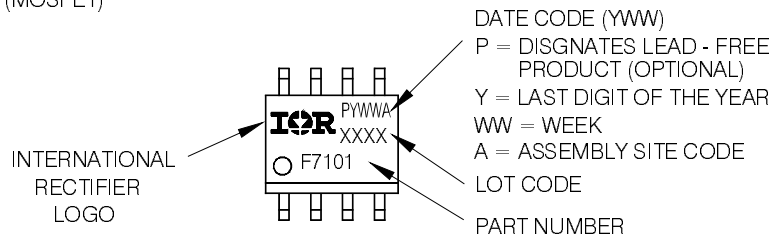
- NOTES:
1. DIMENSIONING & TOLERANCING PER ASME Y14.5M-1994.
  2. CONTROLLING DIMENSION: MILLIMETER
  3. DIMENSIONS ARE SHOWN IN MILLIMETERS [INCHES].
  4. OUTLINE CONFORMS TO JEDEC OUTLINE MS-01 2AA.
  - ⑤ DIMENSION DOES NOT INCLUDE MOLD PROTRUSIONS. MOLD PROTRUSIONS NOT TO EXCEED 0.15 [0.006].
  - ⑥ DIMENSION DOES NOT INCLUDE MOLD PROTRUSIONS. MOLD PROTRUSIONS NOT TO EXCEED 0.25 [0.010].
  - ⑦ DIMENSION IS THE LENGTH OF LEAD FOR SOLDERING TO A SUBSTRATE.

### FOOTPRINT



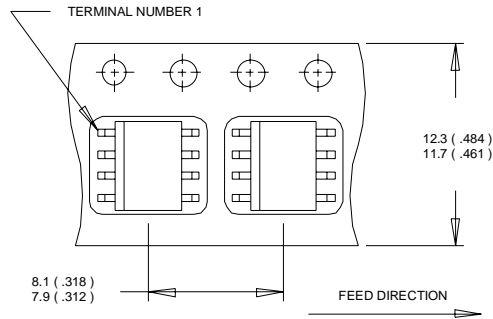
## SO-8 Part Marking Information

EXAMPLE: THIS IS AN IRF7101 (MOSFET)

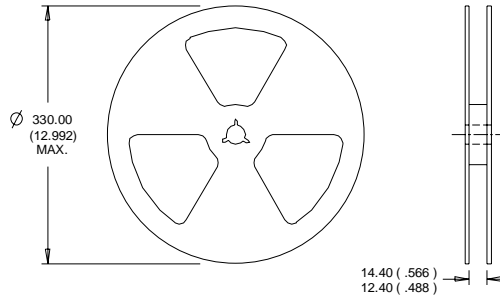


## SO-8 Tape and Reel

Dimensions are shown in millimeters (inches)



- NOTES:
1. CONTROLLING DIMENSION : MILLIMETER.
  2. ALL DIMENSIONS ARE SHOWN IN MILLIMETERS(INCHES).
  3. OUTLINE CONFORMS TO EIA-481 & EIA-541.



- NOTES:
1. CONTROLLING DIMENSION : MILLIMETER.
  2. OUTLINE CONFORMS TO EIA-481 & EIA-541.

Data and specifications subject to change without notice.  
 This product has been designed and qualified for the Industrial market.  
 Qualifications Standards can be found on IR's Web site.