

CCD area image sensor S7170-0909, S7171-0909

512 × 512 pixels, Back-thinned FFT-CCD

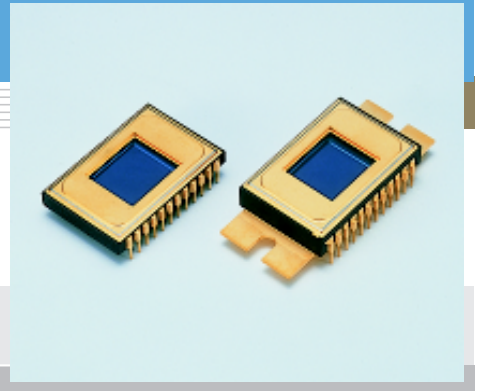

Hamamatsu developed Multi Pin-Phase (MPP) mode back-thinned FFT-CCDs S7170-0909, S7171-0909 specifically designed for low-light-level detection in scientific applications. S7170-0909, S7171-0909 have sensitivity from the UV to near-IR as well as having low dark current and wide dynamic range. Stability of the spectral response curve is also achieved for high precision measurements. Either one-stage or two-stage thermoelectric cooler is built into the package (S7171-0909, S7172-0909). At room temperature operation, the device can be cooled down to -10 °C by one-stage cooler and -30 °C by two-stage cooler, respectively. In addition since both the CCD chip and the thermoelectric cooler are hermetically sealed, no dry air is required, thus allowing easy handling.

Features

- 512 × 512 pixel format
- Greater than 90 % quantum efficiency at peak sensitivity wavelength
- Wide spectrum range
- Low readout noise
- Wide dynamic range
- MPP operation
- Non-cooled types: S7170-0909
- One-stage TE-cooled types: S7171-0909

Applications

- Scientific measuring instrument
- Semiconductor inspection
- UV imaging
- Bio-photon observation

■ Selection guide

Type No.	Cooling	Number of total pixels	Number of active pixels	Active area [mm (H) × mm (V)]
S7170-0909	Non-cooled	532 × 520	512 × 512	12.288 × 12.288
S7171-0909	One-stage TE-cooled	532 × 520	512 × 512	12.288 × 12.288

Note) Two-stage TE-cooled type (S7172-0909) is also available.

■ General ratings

Parameter	S7170-0909	S7171-0909
Pixel size	24 (H) × 24 (V) μm	
Number of active pixels	512 (H) × 512 (V)	
Vertical clock phase	2 phase	
Horizontal clock phase	2 phase	
Output circuit	One-stage MOSFET source follower	
Package	24 pin ceramic DIP (refer to dimensional outlines)	
Built-in cooler	-	One-stage
Window	Sapphire glass *1	

*1: Window-less is available upon request.

■ Absolute maximum ratings (Ta=25 °C)

Parameter	Symbol	Min.	Typ.	Max.	Unit
Operating temperature	Topr	-50	-	+30	°C
Storage temperature	Tstg	-50	-	+70	°C
OD voltage	VOD	-0.5	-	+25	V
RD voltage	VRD	-0.5	-	+18	V
ISV voltage	VISV	-0.5	-	+18	V
ISH voltage	VISH	-0.5	-	+18	V
IGV voltage	VIG1V, VIG2V	-10	-	+15	V
IGH voltage	VIG1H, VIG2H	-10	-	+15	V
SG voltage	VSG	-10	-	+15	V
OG voltage	VOG	-10	-	+15	V
RG voltage	VRG	-10	-	+15	V
TG voltage	VTG	-10	-	+15	V
Vertical clock voltage	VP1V, VP2V	-10	-	+15	V
Horizontal clock voltage	VP1H, VP2H	-10	-	+15	V

■ Operating conditions (MPP mode, Ta=25 °C)

Parameter	Symbol	Min.	Typ.	Max.	Unit	
Output transistor drain voltage	VOD	18	20	22	V	
Reset drain voltage	VRD	11.5	12	12.5	V	
Output gate voltage	VOG	1	3	5	V	
Substrate voltage	VSS	-	0	-	V	
Test point (vertical input source)	VISV	-	VRD	-	V	
Test point (horizontal input source)	VISH	-	VRD	-	V	
Test point (vertical input gate)	VIG1V, VIG2V	-8	0	-	V	
Test point (horizontal input gate)	VIG1H, VIG2H	-8	0	-	V	
Vertical shift register clock voltage	High	VP1VH, VP2VH	4	6	8	V
	Low	VP1VL, VP2VL	-9	-8	-7	
Horizontal shift register clock voltage	High	VP1HH, VP2HH	4	6	8	V
	Low	VP1HL, VP2HL	-9	-8	-7	
Summing gate voltage	High	VSGH	4	6	8	V
	Low	VSGL	-9	-8	-7	
Reset gate voltage	High	VRGH	4	6	8	V
	Low	VRGL	-9	-8	-7	
Transfer gate voltage	High	VTGH	4	6	8	V
	Low	VTGL	-9	-8	-7	

■ Electrical characteristics (Ta=25 °C)

Parameter	Symbol	Min.	Typ.	Max.	Unit
Signal output frequency	fc	-	-	1	MHz
Vertical shift register capacitance	CP1V, CP2V	-	6,400	-	pF
Horizontal shift register capacitance	CP1H, CP2H	-	120	-	pF
Summing gate capacitance	CSG	-	7	-	pF
Reset gate capacitance	CRG	-	7	-	pF
Transfer gate capacitance	CTG	-	150	-	pF
Charge transfer efficiency *2	CTE	0.99995	0.99999	-	-
DC output level *3	Vout	12	15	18	V
Output impedance *3	Zo	-	3	-	kΩ
Power consumption *3 *4	P	-	15	-	mW

*2: Charge transfer efficiency per pixel, measured at half of the full well capacity.

*3: The values depend on the load resistance. (Typical, VOD=20 V, Load resistance=22 kΩ)

*4: Power consumption of the on-chip amplifier.

■ Electrical and optical characteristics (Ta=25 °C, unless otherwise noted)

Parameter		Symbol	Min.	Typ.	Max.	Unit
Saturation output voltage		Vsat	-	Fw × Sv	-	V
Full well capacity	Vertical	Fw	150,000	300,000	-	e ⁻
	Horizontal		300,000	600,000	-	
CCD node sensitivity		Sv	1.8	2.2	-	μV/e ⁻
Dark current *5 (MPP mode)	25 °C	DS	-	4,000	12,000	e ⁻ /pixel/s
	0 °C		-	200	600	
Readout noise *6		Nr	-	8	16	e ⁻ rms
Dynamic range *7	Line binning	DR	18,750	75,000	-	-
	Area scanning		9,375	37,500	-	-
Photo response non-uniformity *8		PRNU	-	±3	±10	%
Spectral response range		λ	-	200 to 1100	-	nm

*5: Dark current nearly doubles for every 5 to 7 °C increase in temperature.

*6: Operating frequency is 150 kHz.

*7: Dynamic Range (DR) = Full well/Readout noise

*8: Measured at half of the full well capacity.

$$\text{Photo Response Non-Uniformity (PRNU) [\%]} = \frac{\text{Fixed pattern noise (peak to peak)}}{\text{Signal}} \times 100$$

■ Spectral response (without window) *9

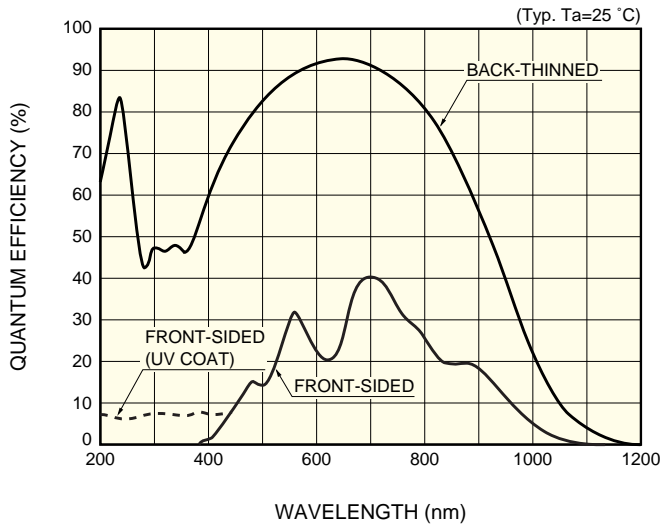

KMPDB0058EA

■ Spectral transmittance characteristic of window material

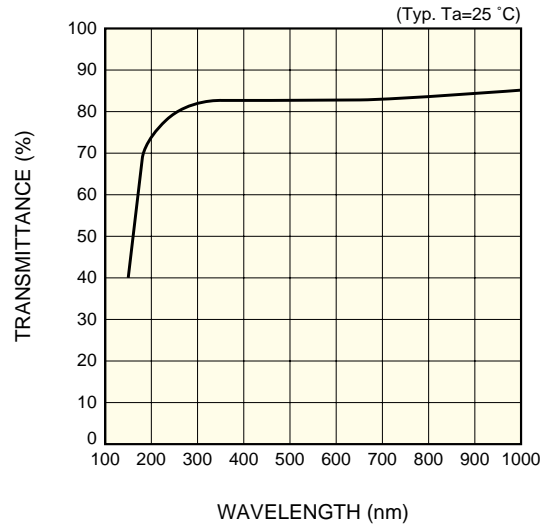

KMPDB0102EA

*9: Spectral response with sapphire window is decreased by the transmittance

● Window material

Type No.	Window material
S7170-0909	Sapphire glass *10 (option: window-less)
S7171-0909	
S7172-0909 (two-stage TE-cooled type)	

*10: Hermetic sealing

■ Dark current vs. temperature

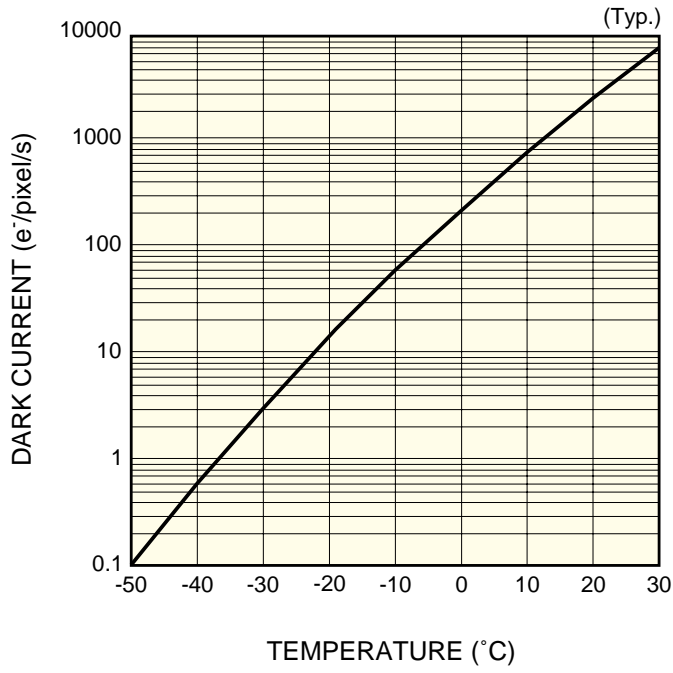

KMPDB0037EB

■ Device structure (Conceptual drawing of top view)

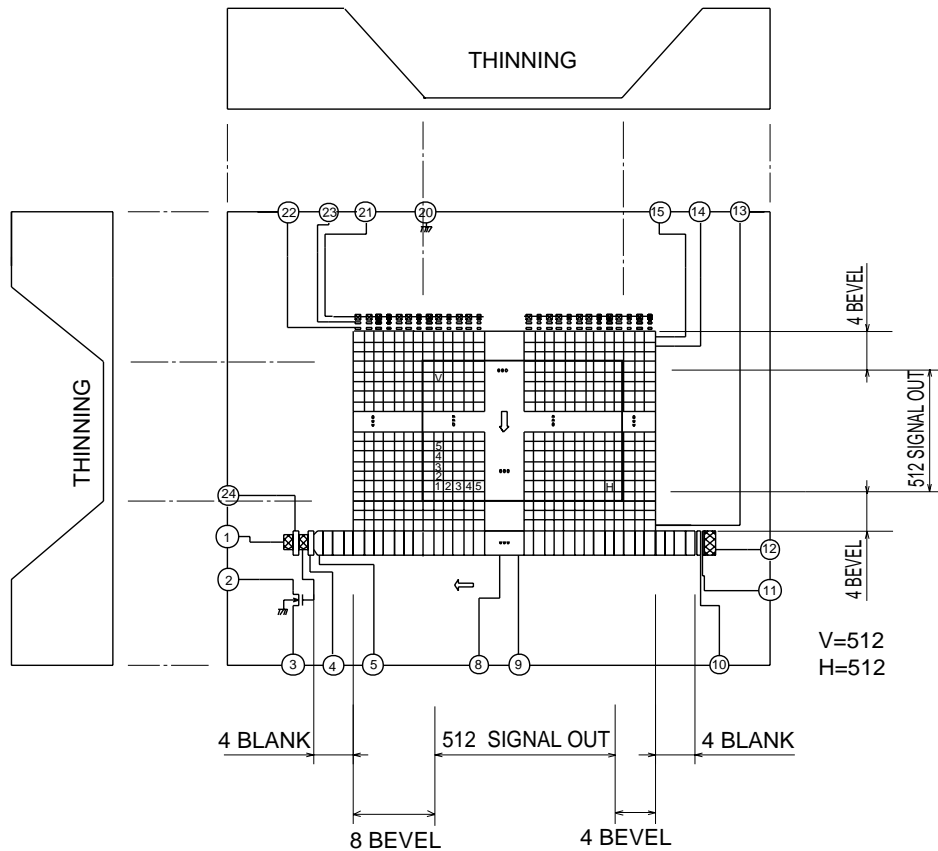

KMPDC0075EA

Area scanning 2 (large full well mode)

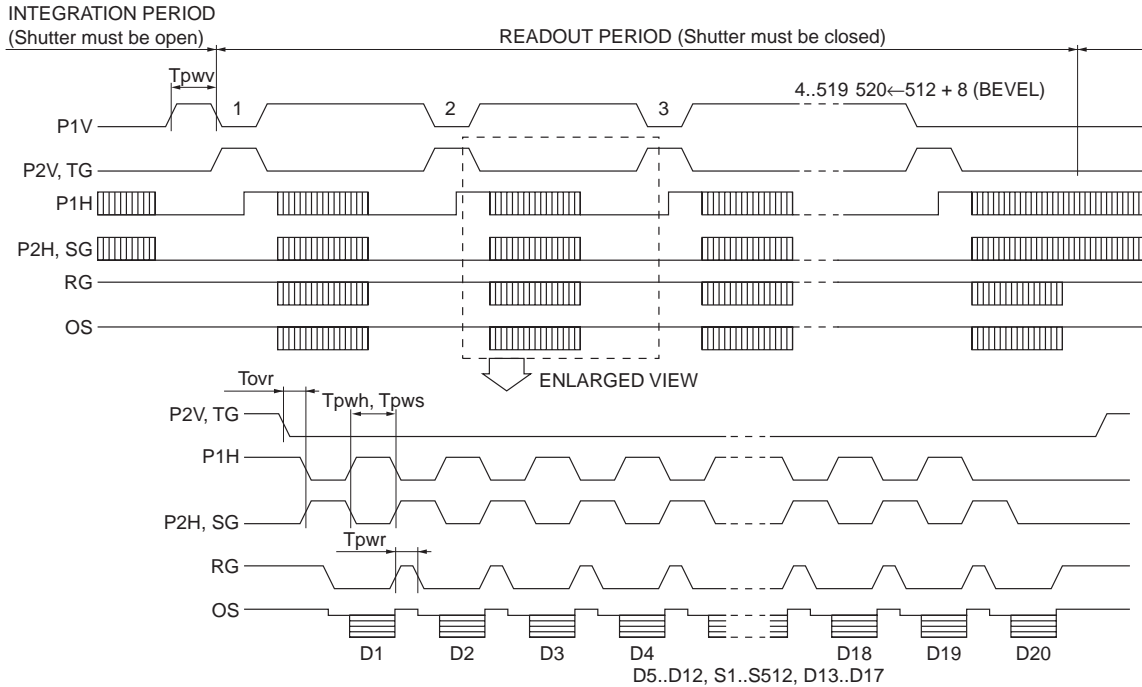

Parameter	Symbol	Remark	Min.	Typ.	Max.	Unit	
P1V, P2V, TG	Pulse width	Tpwv	*12	6	-	-	μs
	Rise and fall time	Tprv, Tpfv		200	-	-	ns
P1H, P2H	Pulse width	Tpwh	*12	500	-	-	ns
	Rise and fall time	Tprh, Tpfh		10	-	-	ns
	Duty ratio	-		-	50	-	%
SG	Pulse width	Tpws	-	500	-	-	ns
	Rise and fall time	Tprs, Tpfs		10	-	-	ns
	Duty ratio	-		-	50	-	%
RG	Pulse width	Tpwr	-	100	-	-	ns
	Rise and fall time	Tpr, Tprf		5	-	-	ns
TG - P1H	Overlap time	Tavr	-	3	-	-	μs

*12: Symmetrical pulses should be overlapped at 50 % of maximum amplitude.

■ Dimensional outlines (unit: mm)

S7170-0909

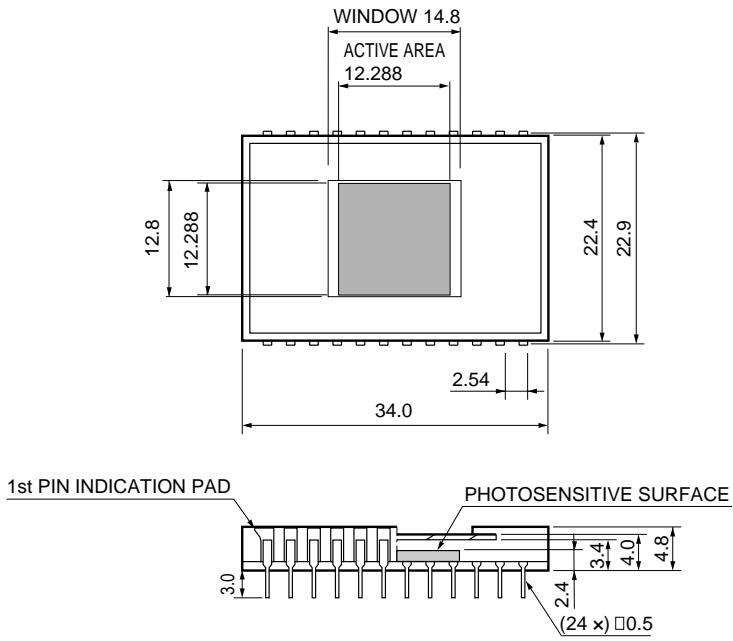

KMPDA0084EA

S7171-0909

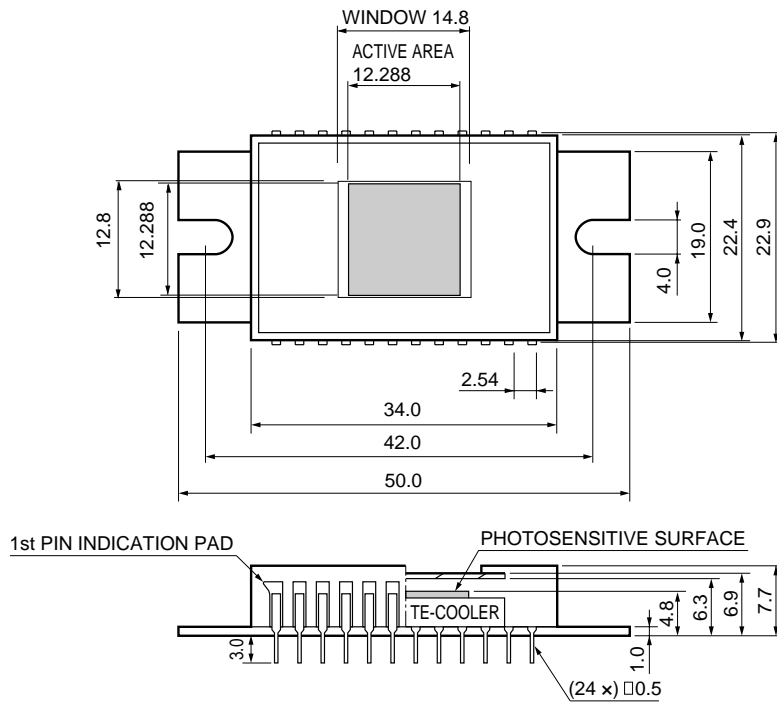

KMPDA0085EB

■ Pin connections

Pin No.	S7170-0909		S7171-0909		Remark (standard operation)
	Symbol	Function	Symbol	Function	
1	RD	Reset drain	RD	Reset drain	+12 V
2	OS	Output transistor source	OS	Output transistor source	$R_L=10\text{ k to }100\text{ k}\Omega$
3	OD	Output transistor drain	OD	Output transistor drain	+20 V
4	OG	Output gate	OG	Output gate	+3 V
5	SG	Summing gate	SG	Summing gate	Same pulse as P2H
6	-		-		
7	-		-		
8	P2H	CCD horizontal register clock-2	P2H	CCD horizontal register clock-2	
9	P1H	CCD horizontal register clock-1	P1H	CCD horizontal register clock-1	
10	IG2H	Test point (horizontal input gate-2)	IG2H	Test point (horizontal input gate-2)	0 V
11	IG1H	Test point (horizontal input gate-1)	IG1H	Test point (horizontal input gate-1)	0 V
12	ISH	Test point (horizontal input source)	ISH	Test point (horizontal input source)	Connect to RD
13	TG *13	Transfer gate	TG *13	Transfer gate	Same pulse as P2V
14	P2V	CCD vertical register clock-2	P2V	CCD vertical register clock-2	
15	P1V	CCD vertical register clock-1	P1V	CCD vertical register clock-1	
16	-		Th1	Thermistor	
17	-		Th2	Thermistor	
18	-		P-	TE-cooler-	
19	-		P+	TE-cooler+	
20	SS	Substrate (GND)	SS	Substrate (GND)	GND
21	ISV	Test point (vertical input source)	ISV	Test point (vertical input source)	Connect to RD
22	IG2V	Test point (vertical input gate-2)	IG2V	Test point (vertical input gate-2)	0 V
23	IG1V	Test point (vertical input gate-1)	IG1V	Test point (vertical input gate-1)	0 V
24	RG	Reset gate	RG	Reset gate	

*13: Isolation gate between vertical register and horizontal register. In standard operation, TG should be applied the same pulse as P2V.

■ Specifications of built-in TE-cooler (S7171-0909)

Parameter	Symbol	Condition	Typ.	Unit
Internal resistance	R_{int}	$T_a=25\text{ }^\circ\text{C}$	2.1	Ω
Maximum current *14	I_{max}	$T_c^{*15}=T_h^{*16}=25\text{ }^\circ\text{C}$	2.0	A
Maximum voltage	V_{max}	$T_c^{*15}=T_h^{*16}=25\text{ }^\circ\text{C}$	4.2	V
Maximum heat absorption *17	Q_{max}		4.5	W
Maximum temperature of heat radiating side	-		70	$^\circ\text{C}$

*14: Maximum current I_{max} :

If the current greater than this value flows into the thermoelectric cooler, the heat absorption begins to decrease due to the Joule heat. It should be noted that this value is not the damage threshold value. To protect the thermoelectric cooler and maintain stable operation, the supply current should be less than 60 % of this maximum current.

*15: Temperature of the cooling side of thermoelectric cooler.

*16: Temperature of the heat radiating side of thermoelectric cooler.

*17: Maximum heat absorption Q_{max} .

This is a theoretical heat absorption level that offsets the temperature difference in the thermoelectric cooler when the maximum current is supplied to the unit.

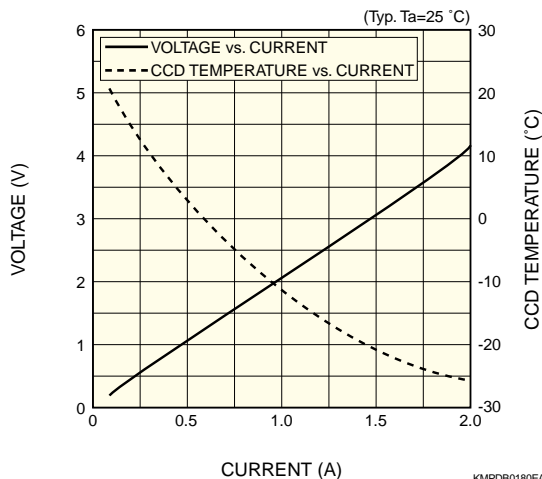

■ Specifications of built-in temperature sensor (S7171-0909)

A chip thermistor is built in the same package with a CCD chip, and the CCD chip temperature can be monitored with it. A relation between the thermistor resistance and absolute temperature is expressed by the following equation.

$$R_1 = R_2 \times \exp B (1 / T_1 - 1 / T_2)$$

where R1 is the resistance at absolute temperature T1 (K)

R2 is the resistance at absolute temperature T2 (K)

B is so-called the B constant (K)

The characteristics of the thermistor used are as follows.

$$R (298K) = 10 \text{ k}\Omega$$

$$B (298K / 323K) = 3450 \text{ K}$$

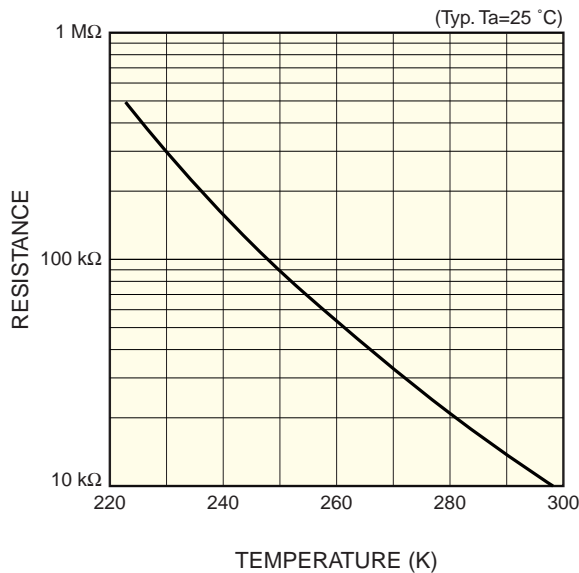

■ Precaution for use (Electrostatic countermeasures)

- Handle these sensors with bare hands or wearing cotton gloves. In addition, wear anti-static clothing or use a wrist band with an earth ring, in order to prevent electrostatic damage due to electrical charges from friction.
- Avoid directly placing these sensors on a work-desk or work-bench that may carry an electrostatic charge.
- Provide ground lines or ground connection with the work-floor, work-desk and work-bench to allow static electricity to discharge.
- Ground the tools used to handle these sensors, such as tweezers and soldering irons.

It is not always necessary to provide all the electrostatic measures stated above. Implement these measures according to the amount of damage that occurs.

■ Element cooling/heating temperature incline rate

Element cooling/heating temperature incline rate should be set at less than 5 K/min.