



General Description

The EC4006 is a monolithic constant current white light LED driver using PWM control method. This device consists of internal temperature compensated reference, voltage comparator, controlled duty cycle oscillator with active current limit circuit, driver and high current output switch. This device is specifically designed be used in Step-Down and Step-Up applications with a few external components.

The EC4006 package is SOP-8.

Features

- Operation input voltage from 3.0V to 36V
- Low Standby Current
- Current Limiting
- Output Switch Current to 0.8A
- Constant output current
- Operation Frequency up to 65KHz (CT=330pF)

Applications

- White light LED driver

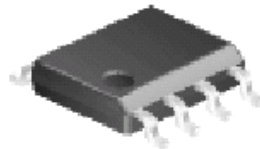

SOP-8

Figure 1. Package Types of EC4006

Ordering Information

Package	Temperature Range	Part Number	Marking ID	Packing Type
SOP-8	-40 to 85	EC4006M	EC4006M	Tape/Reel

EC4006M is a standard tin-lead product, EC4006M-F means a Lead Free product.



Pin Configuration

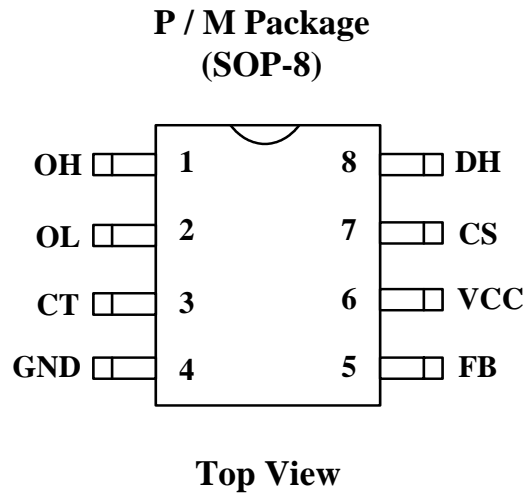

Figure 2. Pin Configuration of EC4006

Functional Block Diagram

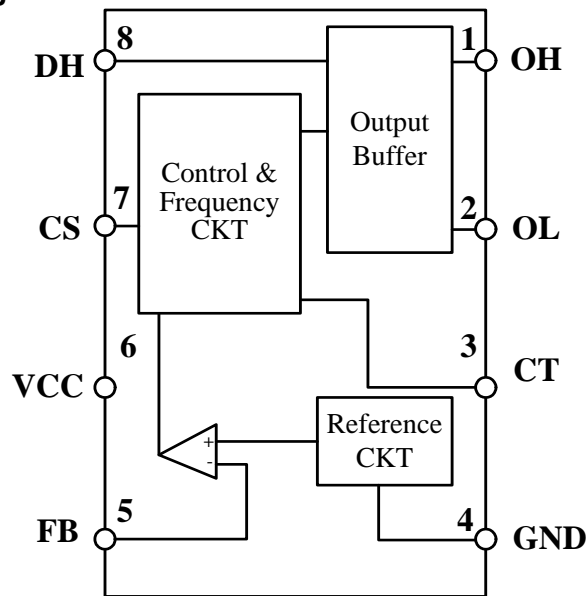

Figure 3. Functional Block Diagram of EC4006



DC/DC WHITE LIGHT LED DRIVER

EC4006

Pin Description

Pin Number	Pin Name	Function
1	OH	Output buffer high voltage pin
2	OL	Output buffer low voltage pin
3	CT	Timing capacitor to control the switching frequency
4	GND	Ground pin for all internal circuits
5	FB	Feedback pin
6	Vcc	Voltage supply
7	CS	Peck current sense Input by monitoring the voltage drop across an external I sense resistor to limit the peak current through the switch
8	DH	Voltage driver output buffer

Absolute Maximum Ratings (Note 1)

Parameter	Symbol	Value	Unit
Power Supply Voltage	Vcc	40	V
Driver Collector Current (Note 2)	Ic(driver)	100	mA
Switch Current	Isw	0.8	A
Power Dissipation and Thermal Characteristics			
Plastic Package,			
Power Dissipation (TA= 25)	Pd	1.25	W
Thermal Resistance	RθJ	100	/W
SOIC Package,			
Power Dissipation (TA= 25)	Pd	625	mW
Thermal Resistance	RθJA	160	/W
Operating Junction Temperature	TJ	+150	
Storage Temperature Range	Tstg	-65 to +150	
ESD (Human body model)		2000	V

Note1: Stresses greater than those listed under "Absolute Maximum Ratings" may cause permanent damage to the device. These are stress ratings only, and functional operation of the device at these or any other conditions beyond those indicated under "Recommended Operating Conditions" is not implied. Exposure to "Absolute Maximum Ratings" for extended periods may affect device reliability.

Note 2: Maximum package power dissipation limits must be observed.

Recommended Operating Conditions

Parameter	Symbol	Min	Max	Unit
Supply Voltage	Vcc	3	36	V
Ambient Temperature	TA	-40	85	



DC/DC WHITE LIGHT LED DRIVER

EC4006

Electrical Characteristics

(V_{CC} = 5.0 V, T_A = -40 to 85 , unless otherwise specified.)

Parameter	Symbol	Conditions	Min	Typ	Max	Unit	
OSCILLATOR							
Frequency	F _{OSC}	V _{pin 5} = 0V CT = 1.0nF	24	35	42	KHz	
		T _A = 25 CT = 330pF	50	65	80	KHz	
Charge Current	I _{CHG}	V _{CC} = 5.0 V to 36 V, T _A = 25	24	35	42	μA	
Discharge Current	I _{DISCHG}	V _{CC} = 5.0 V to 36 V, T _A = 25	140	220	260	μA	
Discharge to Charge Current Ratio	I _{DISCHG} /I _{CHG}	Pin 7 to V _{CC} , T _A = 25	5.2	6.5	7.5		
Current Limit Sense Voltage	V _{IPK(sense)}	I _{CHG} = I _{DISCHG} , T _A = 25	250	300	350	mV	
OUTPUT BUFFER (Note 3)							
Saturation Voltage	V _{HL(sat)}	I _{OB} = 0.6 A, Pins 1, 8 connected		1.0	1.3	V	
Saturation Voltage	V _{HL(sat)}	I _{OB} = 0.6 A, R _{Pin 8} = 82 Ω to V _{CC} , Forced β = 20		0.45	0.8	V	
DC Current Gain	h _{FE}	I _{OB} = 0.6 A, V _{CE} = 5.0 V	50	75			
		T _A = 25					
Output Buffer Off-State Current	I _{OB(off)}	V _{CE} = 36 V		0.01	100	μA	
COMPARATOR							
Threshold Voltage	V _{TH}	T _A = 25 T _A = -40 to 85	1.225 1.21	1.250	1.275 1.29	V	
Threshold Regulation	Voltage	Line	REGLINE	V _{CC} = 3.0 V to 36 V	1.4	5	mV
Input Bias Current			I _{IB}	V _{IN} = 0 V	-20	-400	nA
TOTAL DEVICE							
Supply Current			I _{CC}	V _{CC} = 5.0 V to 36 V, CT = 1.0 nF, Pin 7 = V _{CC} , V _{pin 5} > V _{TH} , Pin 2 = GND, other pins open		4.0	mA

Note 3. Low duty cycle pulse technique is used during test to maintain junction temperature as close to ambient temperature as possible.



Typical Performance Characteristics

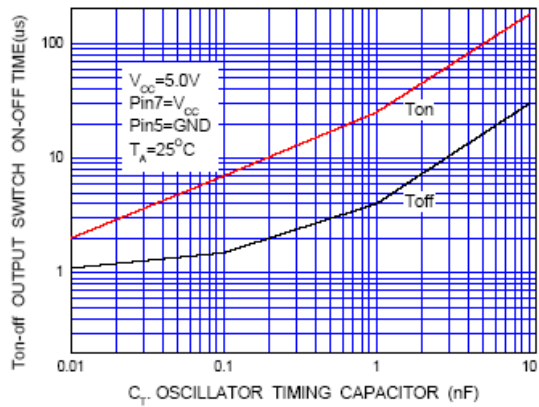

Figure 4. Output Switch On-Off Time vs. Oscillator Timing Capacitor

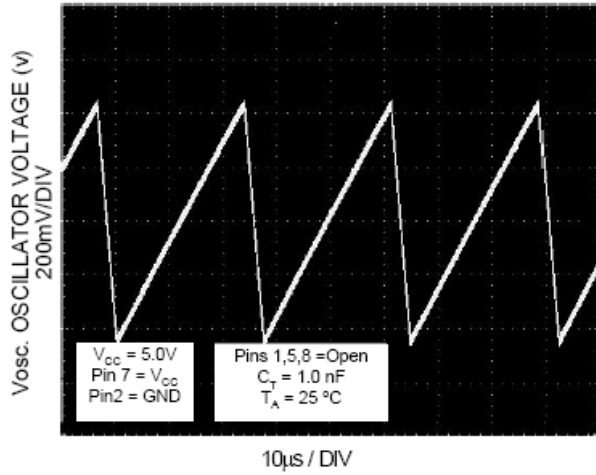

Figure 5. Timing Capacitor Waveform

Typical Applications
(A) Step-Up type

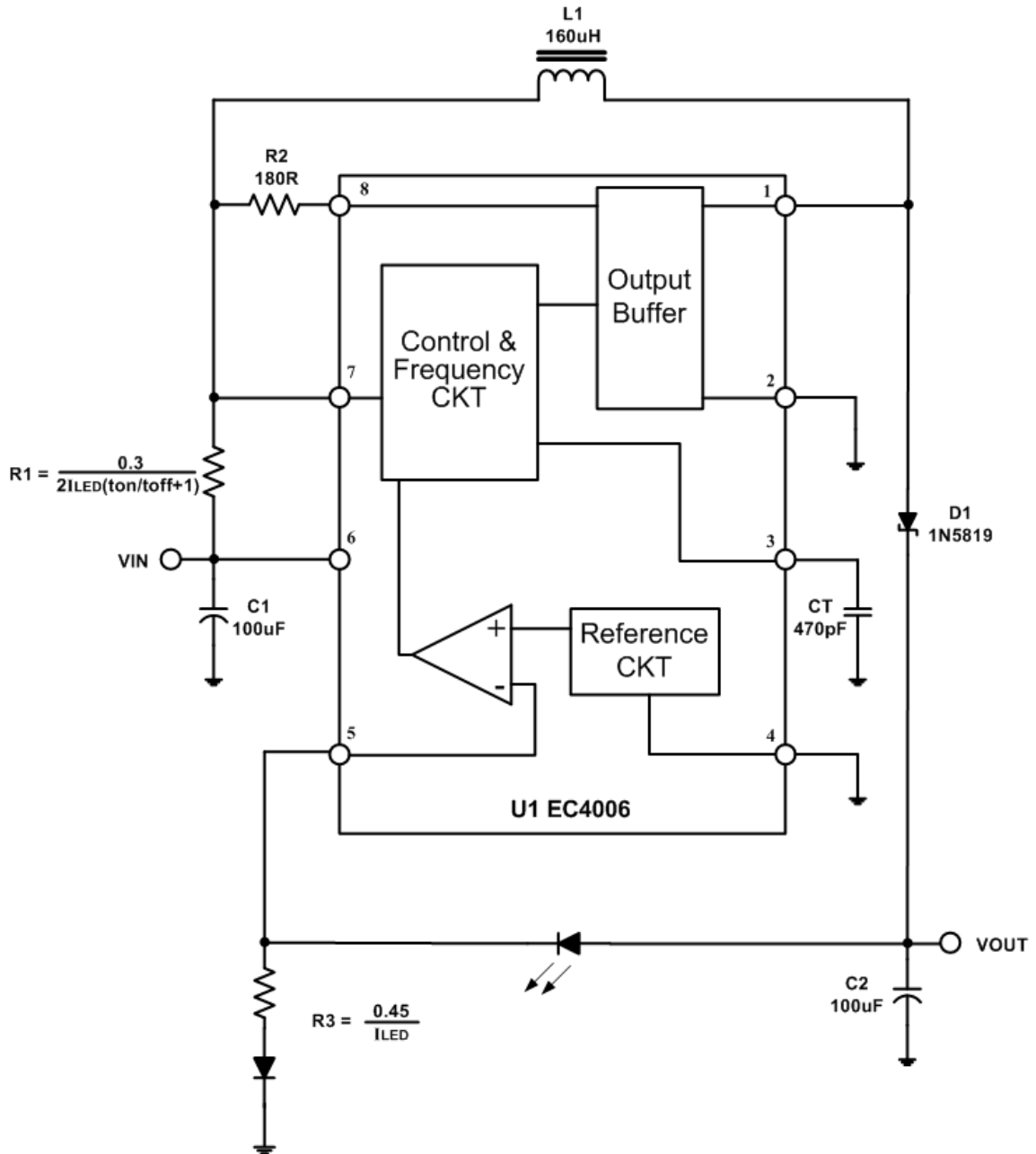

Figure 9. Step-Up type

(B) Step-Down type

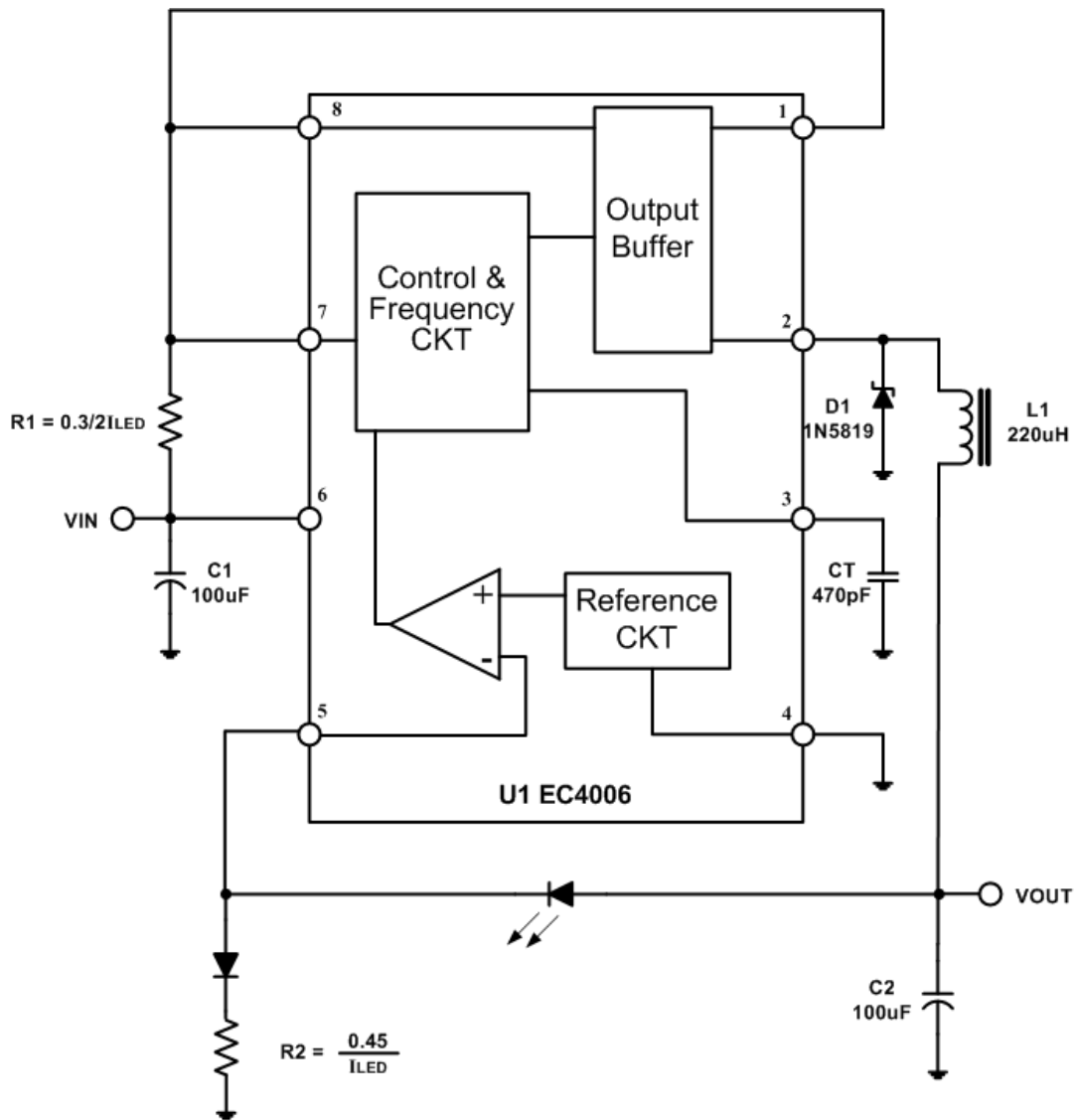

Figure 10. Step-Down type

Mechanical Dimensions

SOIC-8

