

TOSHIBA Intelligent Power Device High Voltage Monolithic Silicon Power IC

TPD4113K

The TPD4113K is a DC brushless motor driver using high-voltage PWM control. It is fabricated using a high-voltage SOI process. The device contains a level shift high side driver, low side driver, IGBT outputs, FRDs and protective functions for over-current and under-voltage protection circuits, and a thermal shutdown circuit. It is easy to control a DC brush less motor by just putting logic inputs from a MPU or motor controller to the TPD4113K.

Features

- Bootstrap circuit gives simple high-side supply.
- Bootstrap diodes are built in.
- A dead time can be set as a minimum of 1.4 μ s and it is the best for a Sine-wave from drive.
- 3-phase bridge output using IGBTs
- FRDs are built in
- Included over-current and under-voltage protection, and thermal shutdown
- The regulator of 7V (typ.) is built in.
- Package: 23-pin HZIP

This product has a MOS structure and is sensitive to electrostatic discharge. When handling this product, ensure that the environment is protected against electrostatic discharge.

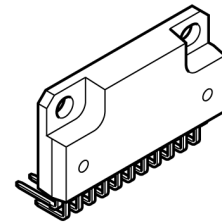

HZIP23-P-1.27F (LBR)

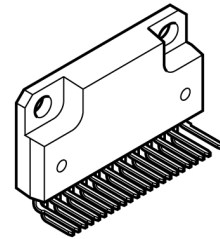

HZIP23-P-1.27G (LBF)

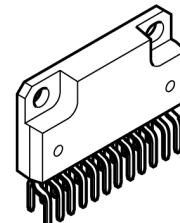

HZIP23-P-1.27H (LB2)

Weight

HZIP23-P-1.27F : 6.1 g (typ.)

HZIP23-P-1.27G : 6.1 g (typ.)

HZIP23-P-1.27H : 6.1 g (typ.)

Pin Assignment

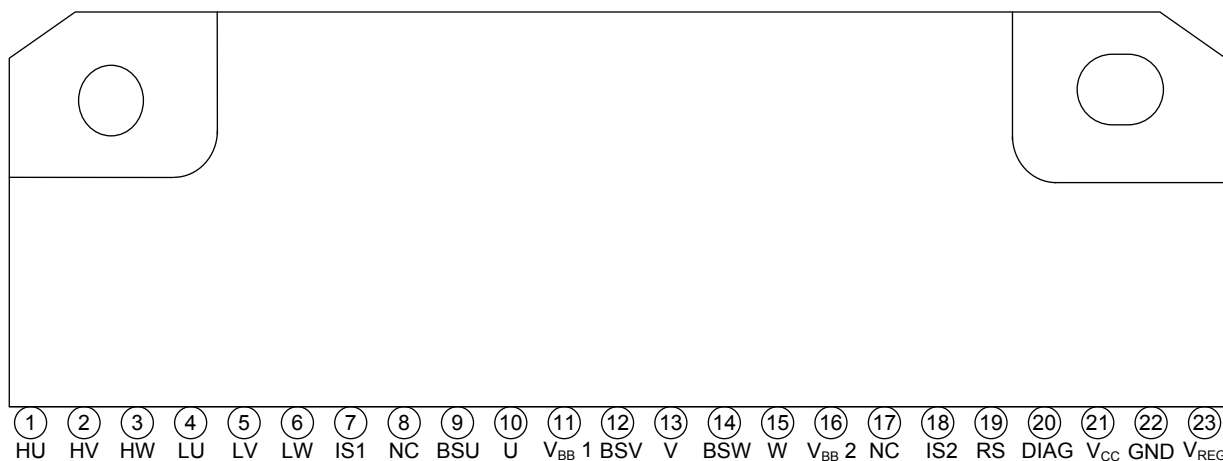

Marking

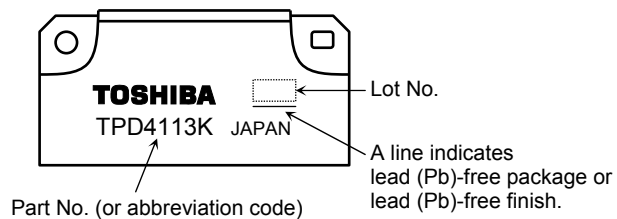

Block Diagram

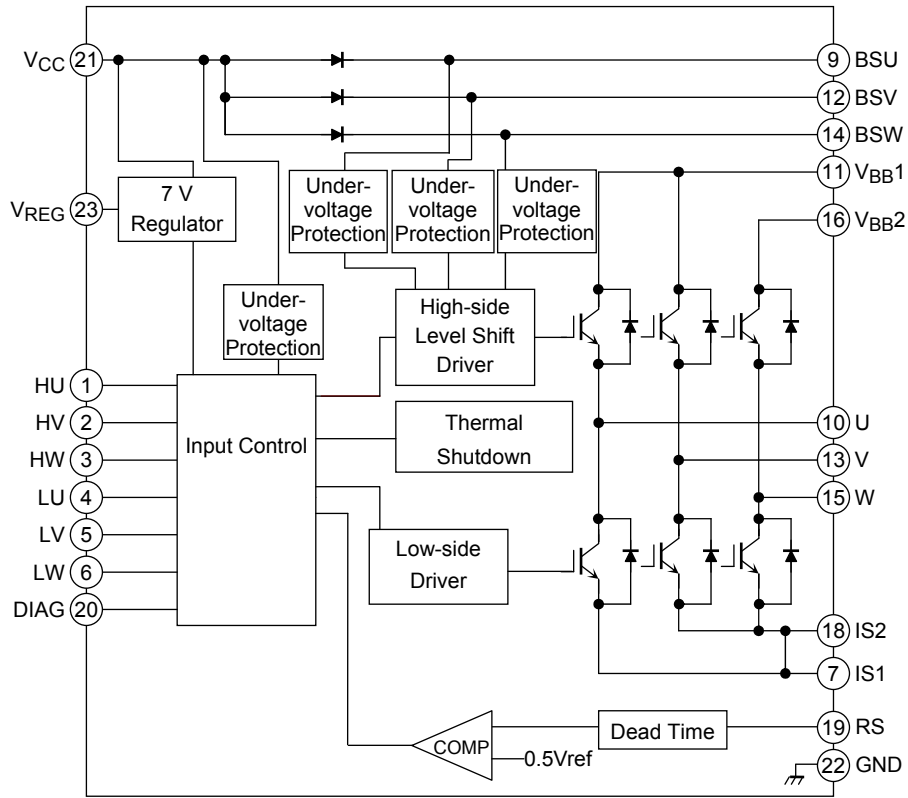

Pin Description

Pin No.	Symbol	Pin Description
1	HU	The control terminal of IGBT by the side of U top arm. It turns off more than by 1.5V. It turns on more than by 3.5V.
2	HV	The control terminal of IGBT by the side of V top arm. It turns off more than by 1.5V. It turns on more than by 3.5V.
3	HW	The control terminal of IGBT by the side of W top arm. It turns off more than by 1.5V. It turns on more than by 3.5V.
4	LU	The control terminal of IGBT by the side of U bottom arm. It turns off more than by 1.5V. It turns on more than by 3.5V.
5	LV	The control terminal of IGBT by the side of V bottom arm. It turns off more than by 1.5V. It turns on more than by 3.5V.
6	LW	The control terminal of IGBT by the side of W bottom arm. It turns off more than by 1.5V. It turns on more than by 3.5V.
7	IS1	IGBT emitter and FRD anode pin.
8	NC	Unused pin, which is not connected to the chip internally.
9	BSU	U-phase bootstrap capacitor connecting pin.
10	U	U-phase output pin.
11	V _{BB1}	U and V-phase high-voltage power supply input pin.
12	BSV	V-phase bootstrap capacitor connecting pin.
13	V	V-phase output pin.
14	BSW	W-phase bootstrap capacitor connecting pin.
15	W	W-phase output pin.
16	V _{BB2}	W-phase high-voltage power supply input pin.
17	NC	Unused pin, which is not connected to the chip internally.
18	IS2	IGBT emitter and FRD anode pin.
19	RS	Over current detection pin. (Connect a current-detecting resistor to this pin.)
20	DIAG	With the diagnostic output terminal of open drain , a pull-up is carried out by resistance. It turns it on at the time of unusual.
21	V _{CC}	Control power supply pin.(15V typ.)
22	GND	Ground pin.
23	V _{REG}	7V regulator output pin.

Equivalent Circuit of Input Pins

Internal circuit diagram of HU, HV, HW, LU, LV, LW input pins

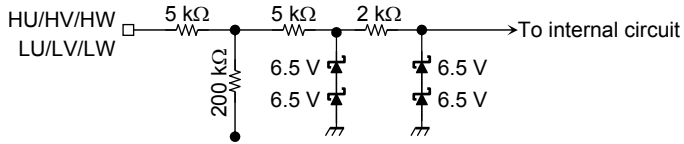

Internal circuit diagram of DIAG pin

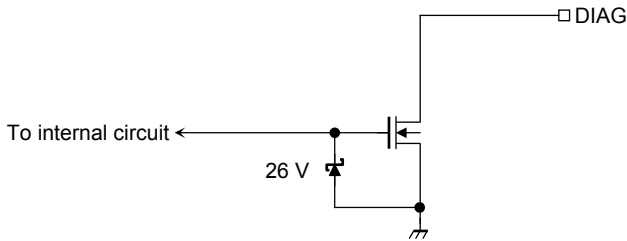

Internal circuit diagram of RS pin

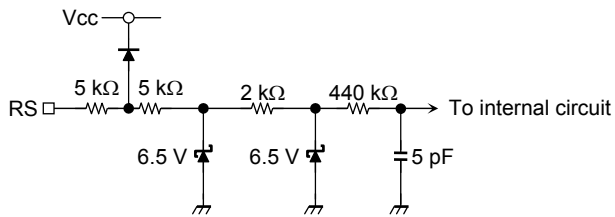

Timing Chart

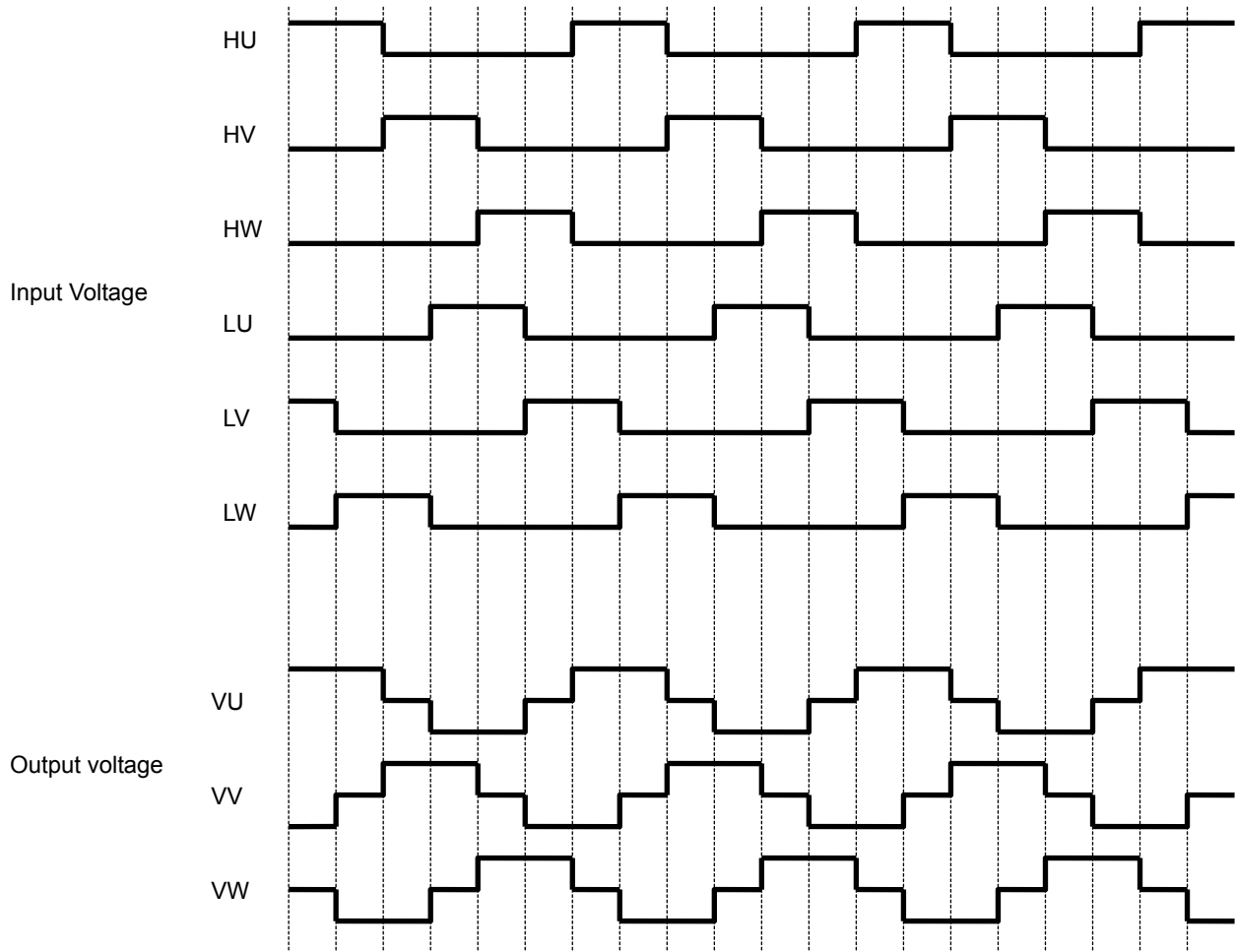

Truth Table

Mode	Input						Top arm			Bottom arm			DIAG
	HU	HV	HW	LU	LV	LW	U phase	V phase	W phase	U phase	V phase	W phase	
Normal	H	L	L	L	H	L	ON	OFF	OFF	OFF	ON	OFF	OFF
	H	L	L	L	L	H	ON	OFF	OFF	OFF	OFF	ON	OFF
	L	H	L	L	L	H	OFF	ON	OFF	OFF	OFF	ON	OFF
	L	H	L	H	L	L	OFF	ON	OFF	ON	OFF	OFF	OFF
	L	L	H	H	L	L	OFF	OFF	ON	ON	OFF	OFF	OFF
	L	L	H	L	H	L	OFF	OFF	ON	OFF	ON	OFF	OFF
Over-current	H	L	L	L	H	L	OFF	OFF	OFF	OFF	OFF	OFF	ON
	H	L	L	L	L	H	OFF	OFF	OFF	OFF	OFF	OFF	ON
	L	H	L	L	L	H	OFF	OFF	OFF	OFF	OFF	OFF	ON
	L	H	L	H	L	L	OFF	OFF	OFF	OFF	OFF	OFF	ON
	L	L	H	H	L	L	OFF	OFF	OFF	OFF	OFF	OFF	ON
	L	L	H	L	H	L	OFF	OFF	OFF	OFF	OFF	OFF	ON
Thermal shutdown	H	L	L	L	H	L	OFF	OFF	OFF	OFF	OFF	OFF	ON
	H	L	L	L	L	H	OFF	OFF	OFF	OFF	OFF	OFF	ON
	L	H	L	L	L	H	OFF	OFF	OFF	OFF	OFF	OFF	ON
	L	H	L	H	L	L	OFF	OFF	OFF	OFF	OFF	OFF	ON
	L	L	H	H	L	L	OFF	OFF	OFF	OFF	OFF	OFF	ON
	L	L	H	L	H	L	OFF	OFF	OFF	OFF	OFF	OFF	ON
Under-voltage	H	L	L	L	H	L	OFF	OFF	OFF	OFF	OFF	OFF	ON
	H	L	L	L	L	H	OFF	OFF	OFF	OFF	OFF	OFF	ON
	L	H	L	L	L	H	OFF	OFF	OFF	OFF	OFF	OFF	ON
	L	H	L	H	L	L	OFF	OFF	OFF	OFF	OFF	OFF	ON
	L	L	H	H	L	L	OFF	OFF	OFF	OFF	OFF	OFF	ON
	L	L	H	L	H	L	OFF	OFF	OFF	OFF	OFF	OFF	ON

Notes: Release of Thermal shutdown protection and under voltage protection depends release of a self-reset and over current protection on an all "L" input.

Absolute Maximum Ratings (Ta = 25°C)

Characteristics	Symbol	Rating	Unit
Power supply voltage	V _{BB}	500	V
	V _{CC}	18	V
Output current (DC)	I _{out}	1	A
Output current (pulse)	I _{out}	2	A
Input voltage	V _{IN}	-0.5~7	V
V _{REG} current	I _{REG}	50	mA
Power dissipation (Ta = 25°C)	P _C	4	W
Power dissipation (Tc = 25°C)	P _C	20	W
Operating temperature	T _{jopr}	-20~135	°C
Junction temperature	T _j	150	°C
Storage temperature	T _{stg}	-55~150	°C
Lead-heat sink isolation voltage	V _{hs}	1000 (1 min)	V _{rms}

Note: Using continuously under heavy loads (e.g. the application of high temperature/current/voltage and the significant change in temperature, etc.) may cause this product to decrease in the reliability significantly even if the operating conditions (i.e. operating temperature/current/voltage, etc.) are within the absolute maximum ratings and the operating ranges.

Please design the appropriate reliability upon reviewing the Toshiba Semiconductor Reliability Handbook ("Handling Precautions"/Derating Concept and Methods) and individual reliability data (i.e. reliability test report and estimated failure rate, etc).

Electrical Characteristics (Ta = 25°C)

Characteristics	Symbol	Test Condition	Min	Typ.	Max	Unit
Operating power supply voltage	V _{BB}	—	50	280	450	V
	V _{CC}	—	13.5	15	16.5	
Current dissipation	I _{BB}	V _{BB} = 450 V	—	—	0.5	mA
	I _{CC}	V _{CC} = 15 V	—	1.1	5	
	I _{BS} (ON)	V _{BS} = 15 V, high side ON	—	260	410	μA
	I _{BS} (OFF)	V _{BS} = 15 V, high side OFF	—	230	370	
Input voltage	V _{IH}	V _{IN} = "H"	3.5	—	—	V
	V _{IL}	V _{IN} = "L"	—	—	1.5	
Input current	I _{IH}	V _{IN} = 5 V	—	—	150	μA
	I _{IL}	V _{IN} = 0 V	—	—	100	
Output saturation voltage	V _{CEsatH}	V _{CC} = 15 V, I _C = 0.5 A	—	2.4	3	V
	V _{CEsatL}	V _{CC} = 15 V, I _C = 0.5 A	—	2.4	3	
FRD forward voltage	V _{FH}	I _F = 0.5 A, high side	—	1.6	2.0	V
	V _{FL}	I _F = 0.5 A, low side	—	1.6	2.0	
Regulator voltage	V _{REG}	I _F = 500 μA	—	0.9	1.2	V
BSD forward voltage	V _F (BSD)	V _{CC} = 15 V, I _O = 30 mA	6.5	7	7.5	V
Current limiting voltage	V _R	—	0.46	0.5	0.54	V
Current limiting dead time	Dt	—	2.3	3.3	4.4	μs
Thermal shutdown temperature	TSD	V _{CC} = 15 V	135	—	185	°C
Thermal shutdown hysteresis	ΔTSD	V _{CC} = 15 V	—	50	—	°C
V _{CC} under-voltage protection	V _{CCUVD}	—	10	11	12	V
V _{CC} under-voltage protection recovery	V _{CCUVR}	—	10.5	11.5	12.5	V
V _{BS} under-voltage protection	V _{BSUVD}	—	8	9	9.5	V
V _{BS} under-voltage protection recovery	V _{BSUVR}	—	8.5	9.5	10.5	V
DIAG saturation voltage	V _{DIAGsat}	I _{DIAG} = 5mA	—	—	0.5	V
Output-on delay time	t _{on}	V _{BB} = 280 V, I _C = 0.5 A	—	1.5	3	μs
Output-off delay time	t _{off}	V _{BB} = 280 V, I _C = 0.5 A	—	1.2	3	μs
Dead time	t _{dead}	V _{BB} = 280 V, I _C = 0.5 A	1.4	—	—	μs
FRD reverse recovery time	t _{rr}	V _{BB} = 280 V, I _C = 0.5 A	—	200	—	ns

Application Circuit Example

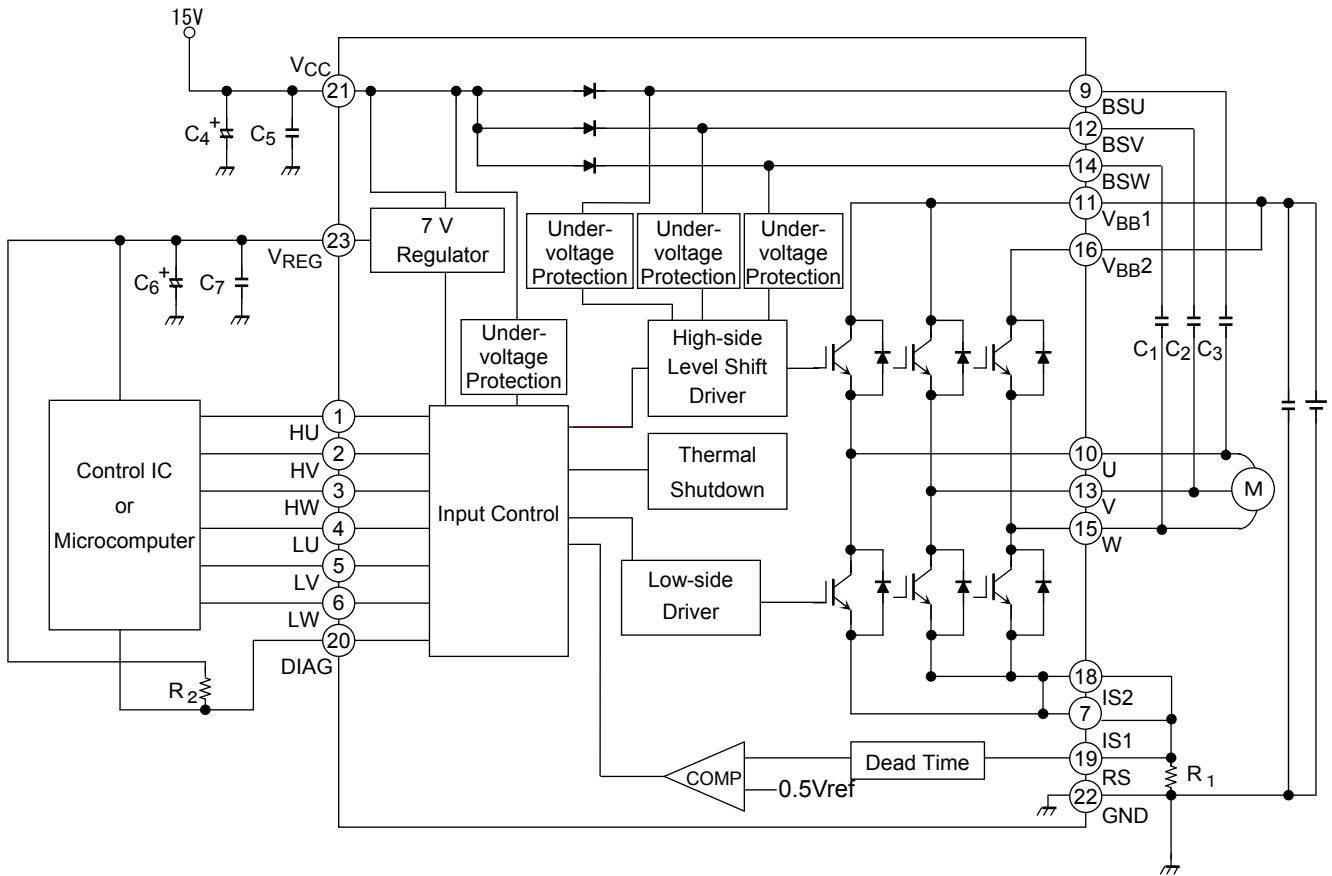

External Parts

Standard external parts are shown in the following table.

Part	Recommended Value	Purpose	Remarks
C ₁ , C ₂ , C ₃	25 V/2.2 μ F	Bootstrap capacitor	(Note 1)
R ₁	0.62 $\Omega \pm 1\%$ (1 W)	Current detection	(Note 2)
C ₄	25 V/10 μ F	V _{CC} power supply stability	(Note 3)
C ₅	25 V /0.1 μ F	V _{CC} for surge absorber	(Note 3)
C ₆	16 V/1 μ F	V _{REG} power supply stability	(Note 3)
C ₇	16 V/1000 pF	V _{REG} for surge absorber	(Note 3)
R ₂	5.1 k Ω	FG pin pull-up resistor	(Note 4)

Note 1: The required bootstrap capacitance value varies according to the motor drive conditions. The capacitor is biased by V_{CC} and must be sufficiently derated for it.

Note 2: The following formula shows the detection current: $I_O = V_R \div R_1$ (For $V_R = 0.5$ V)
Do not exceed a detection current of 1 A when using this product.

Note 3: When using this product, some adjustment is required in accordance with the use environment. When mounting, place as close to the base of this product leads as possible to improve the ripple and noise elimination.

Note 4: The DIAG pin is open drain. Note that when the DIAG pin is connected to a power supply with a voltage higher than or equal to the V_{CC}, a protection circuit is triggered so that the current flows continuously. If the DIAG pin is not used, connect to the GND.

Handling precautions

- (1) Please control the input signal in the state to which the V_{CC} voltage is steady. Both of the order of the V_{BB} power supply and the V_{CC} power supply are not cared about either.
Note that if the power supply is switched off as described above, this product may be destroyed if the current regeneration route to the V_{BB} power supply is blocked when the V_{BB} line is disconnected by a relay or similar while the motor is still running.
- (2) The RS pin connecting the current detection resistor is connected to a comparator in the IC and also functions as a sensor pin for detecting over current. As a result, over voltage caused by a surge voltage, for example, may destroy the circuit. Accordingly, be careful of handling the IC or of surge voltage in its application environment.

Description of Protection Function

(1) Over-current protection

This product incorporates the over-current protection circuit to protect itself against over-current at startup or when a motor is locked. This protection function detects voltage generated in the current detection resistor connected to the RS pin. When this voltage exceeds $V_R = 0.5 \text{ V}$ (typ.), the IGBT output, which is on, temporarily shuts down after a dead time, preventing any additional current from flowing to this product. The next all “L” signal releases the shutdown state.

(2) Under-voltage protection

This product incorporates an under-voltage protection circuit to prevent the IGBT from operating in unsaturated mode when the VCC voltage or the VBS voltage drops.

When the VCC power supply falls to this product internal setting ($V_{CCUVD} = 11 \text{ V}$ typ.), all IGBT outputs shut down regardless of the input. This protection function has hysteresis. When the V_{CCUVR} (= 11.5 V typ.) reaches 0.5 V higher than the shutdown voltage, this product is automatically restored and the IGBT is turned on/off again by the input.

When the VBS supply voltage drops ($V_{BSUVD} = 9 \text{ V}$ typ.), the high-side IGBT output shuts down. When the V_{BSUVR} (= 9.5 V typ.) reaches 0.5 V higher than the shutdown voltage, the IGBT is turned on/off again by the input signal.

(3) Thermal shutdown

This product incorporates a thermal shutdown circuit to protect itself against excessive rise in temperature. When the temperature of this chip rises to the internal setting TSD due to external causes or internal heat generation all IGBT outputs shut down regardless of the input. This protection function has hysteresis ($\Delta TSD = 50^\circ\text{C}$ typ.). When the chip temperature falls to $TSD - \Delta TSD$, the chip is automatically restored and the IGBT is turned on/off again by the input. Because the chip contains just one temperature-detection location, when the chip heats up due to the IGBT, for example, the differences in distance between the detection location and the IGBT (the source of the heat) can cause differences in the time taken for shutdown to occur. Therefore, the temperature of the chip may rise higher than the initial thermal shutdown temperature.

Safe Operating Area

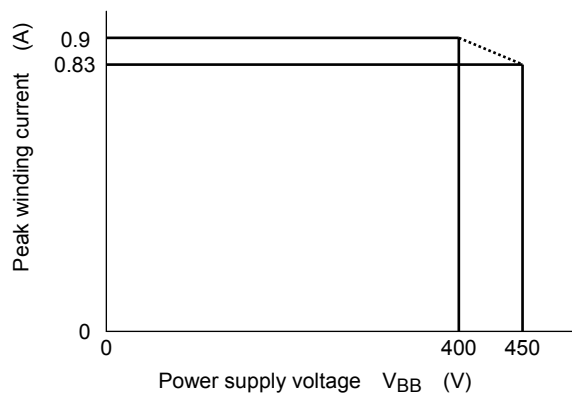

Figure 1 SOA at Tj = 135°C

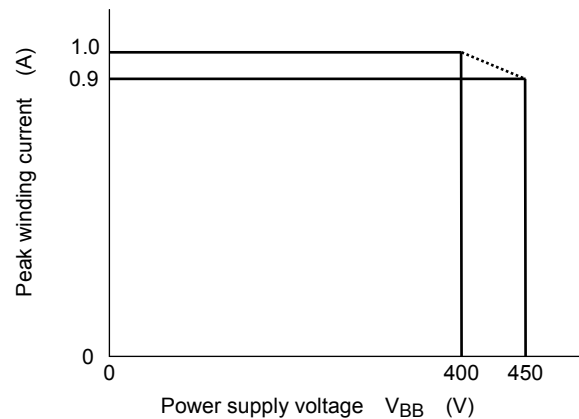
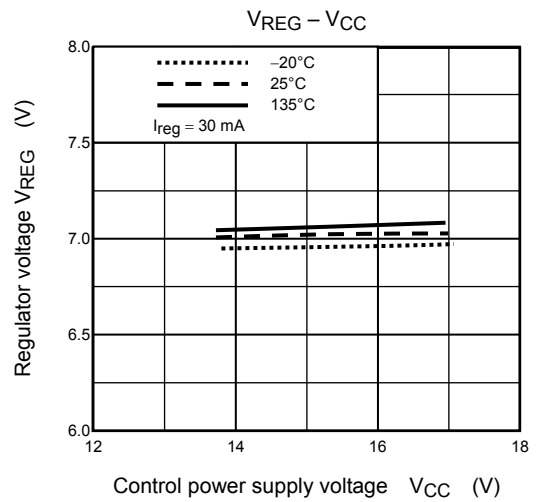
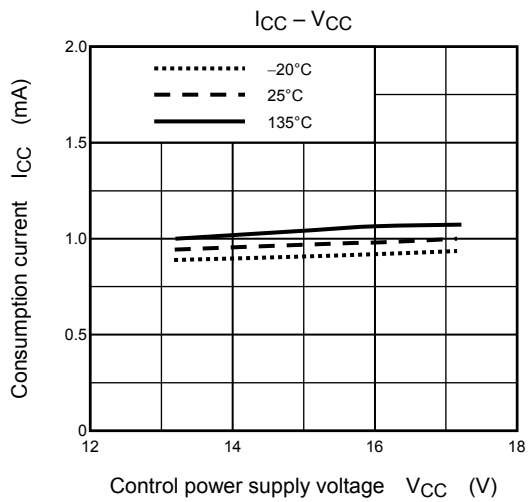
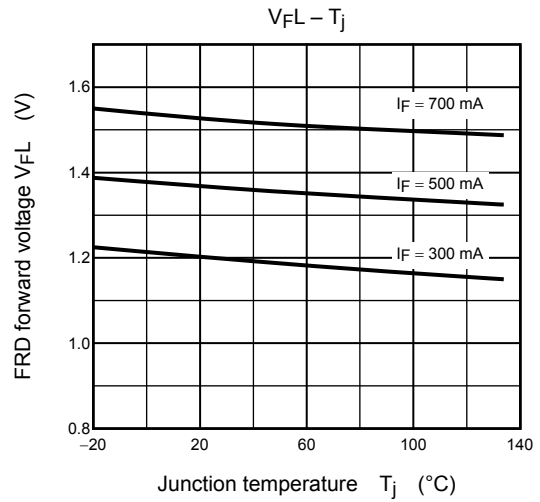
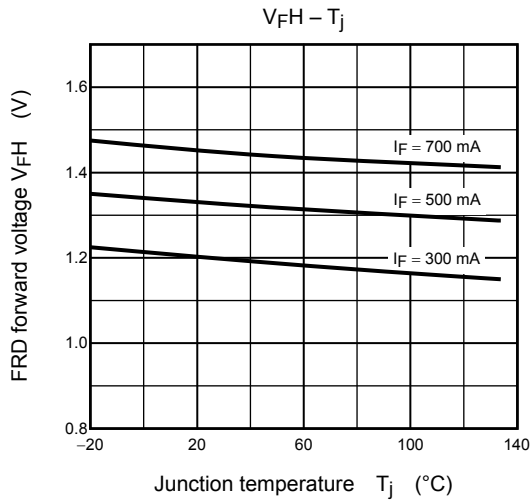
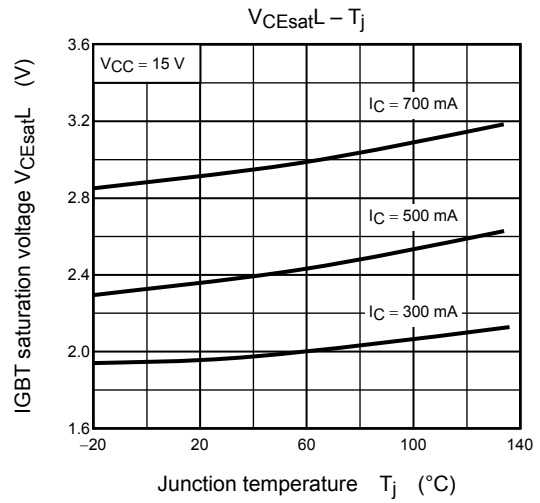
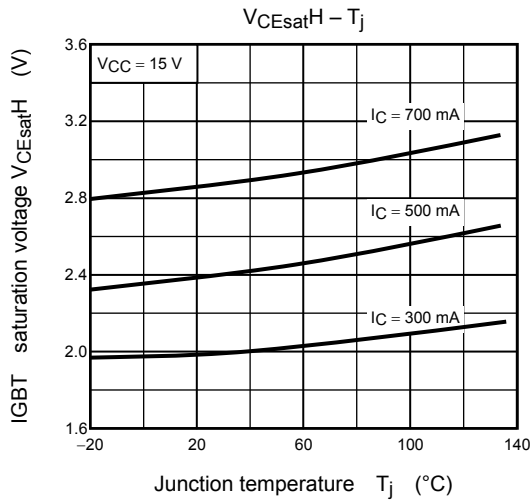
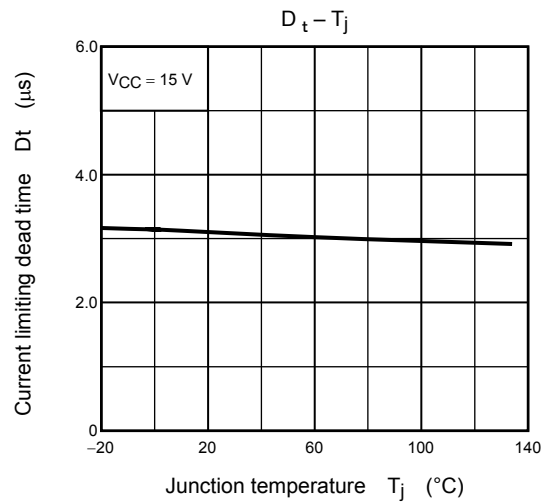
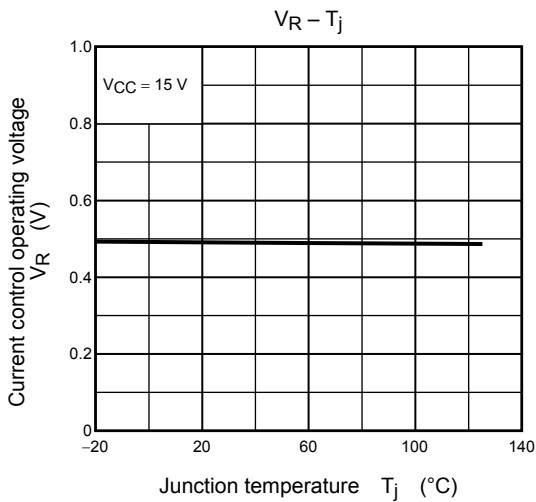
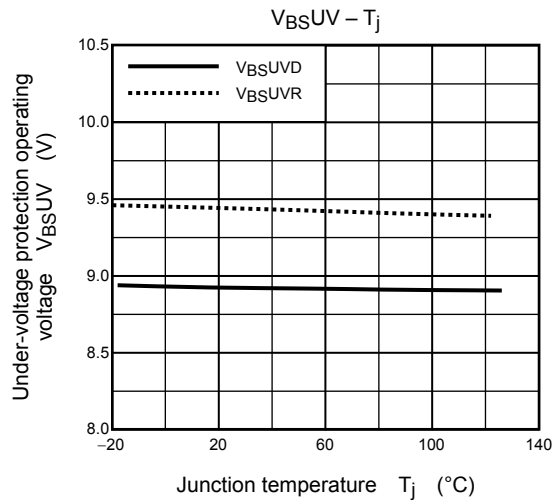
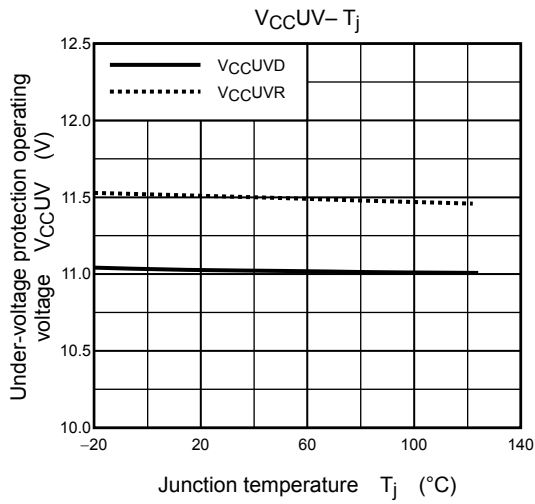
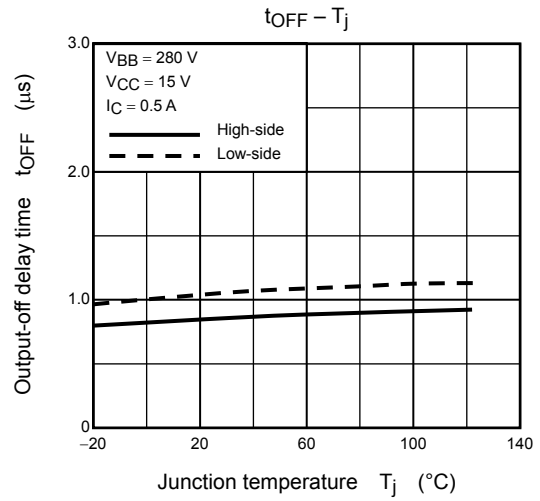
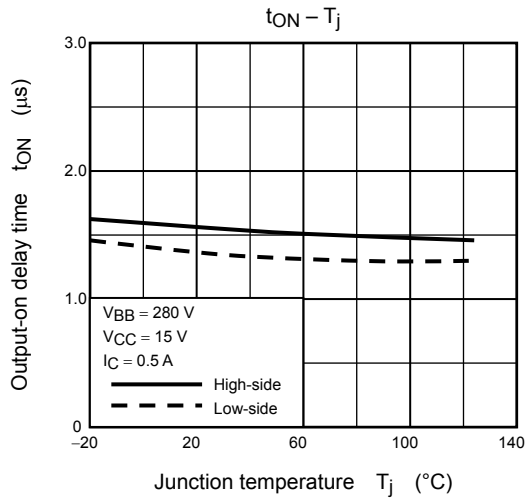

Figure 2 SOA at Tc = 95°C

Note 1: The above safe operating areas are at Tj = 135°C (Figure 1) and Tc = 95°C (Figure 2). If the temperature exceeds these, the safe operation areas are reduced.

Note 2: The above safe operating areas include the over-current protection operation area.





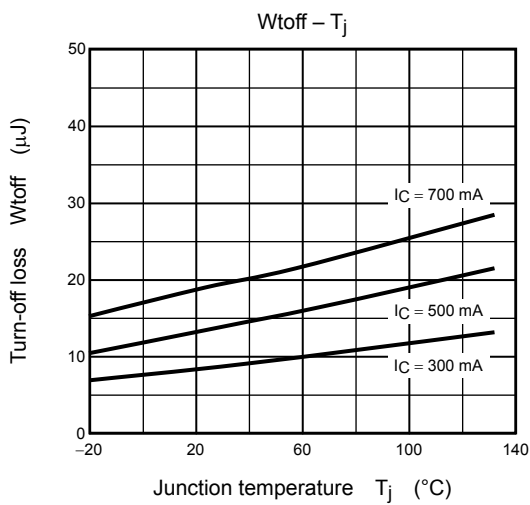
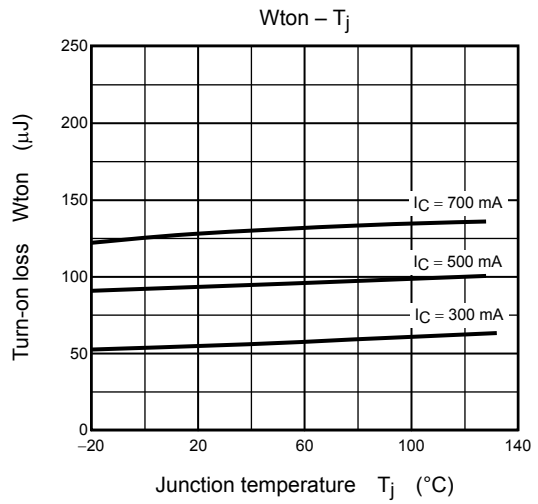
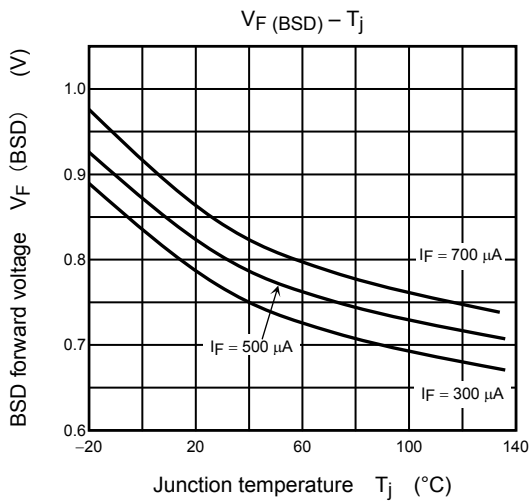
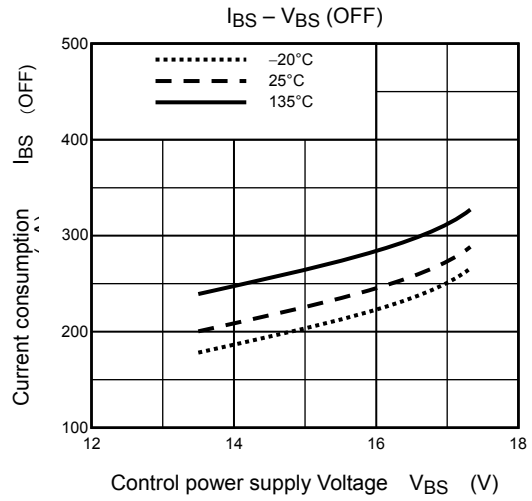
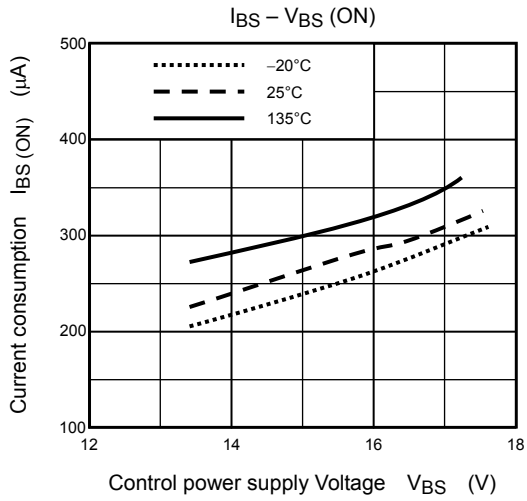

Test Circuits

IGBT Saturation Voltage (U-phase low side)

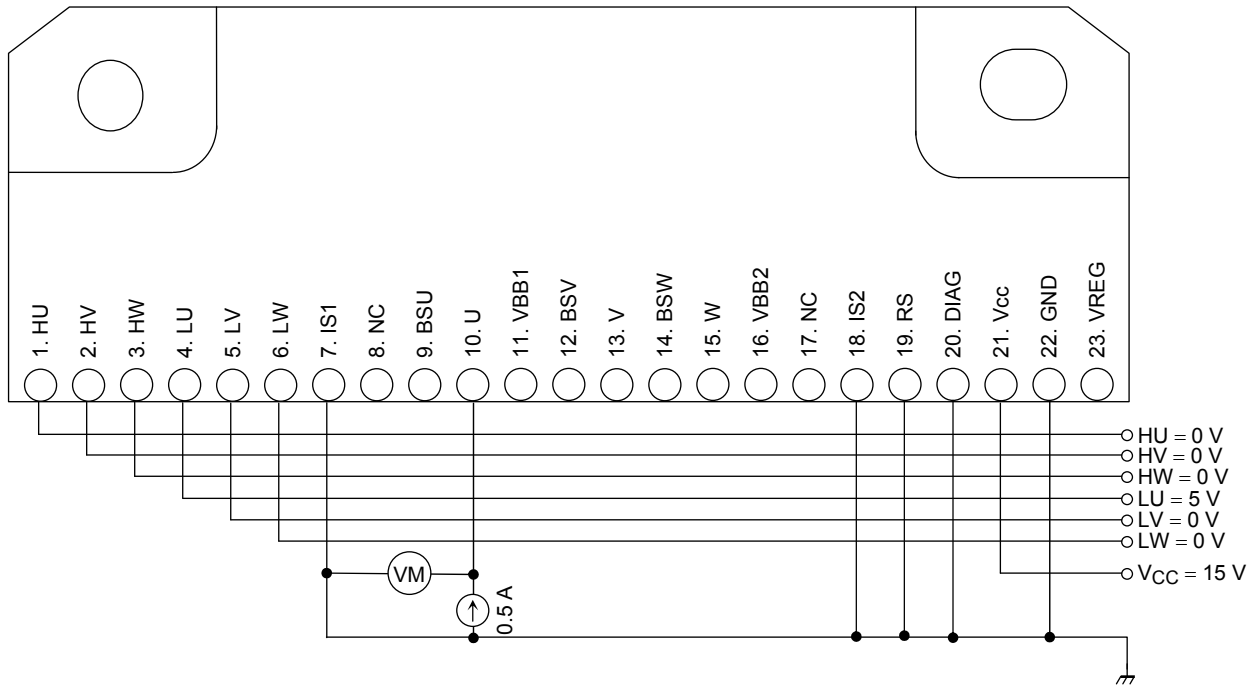

FRD Forward Voltage (U-phase low side)

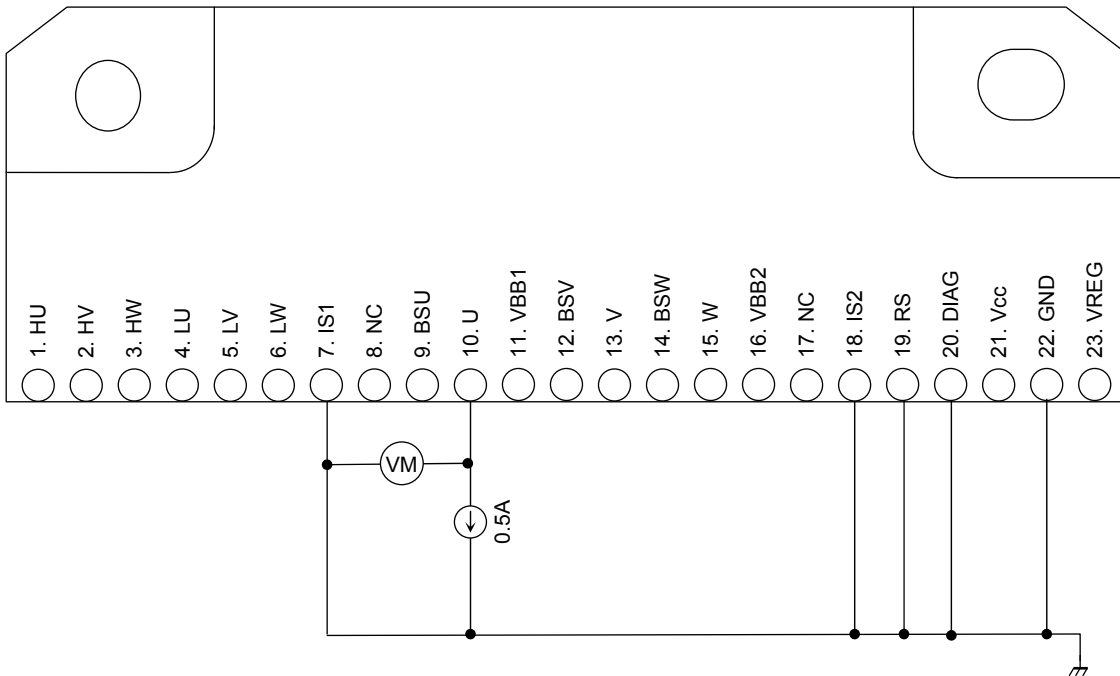

V_{CC} Current Dissipation

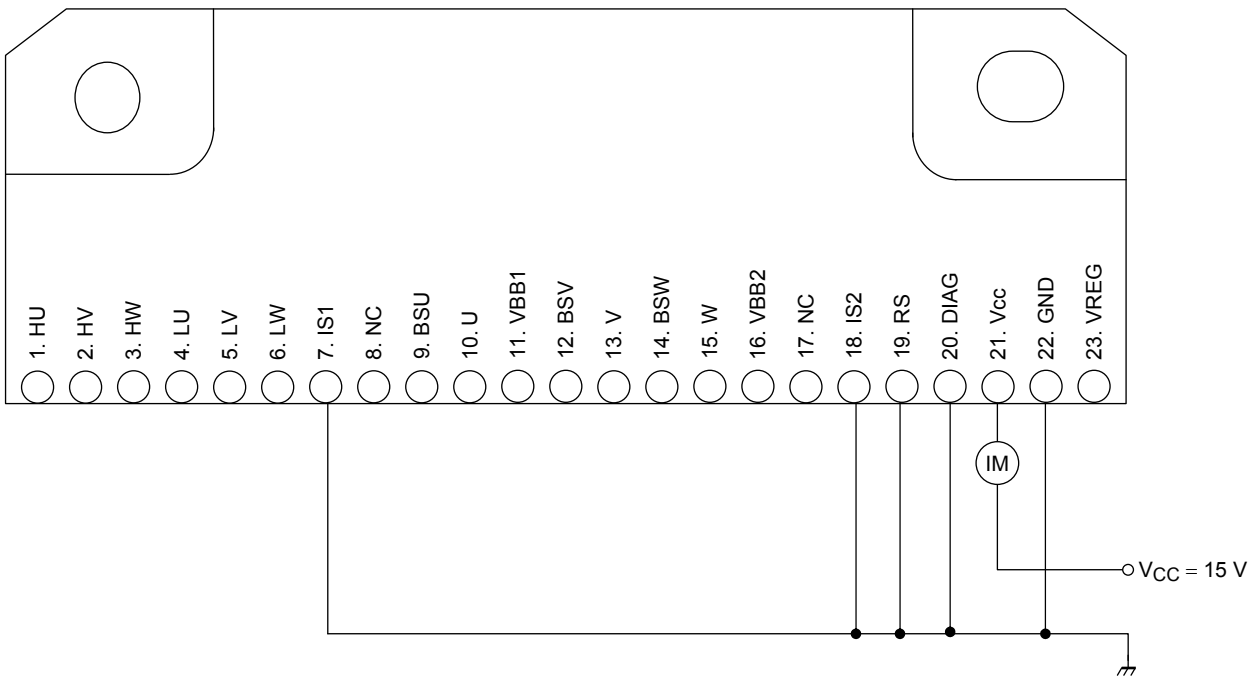

Regulator Voltage

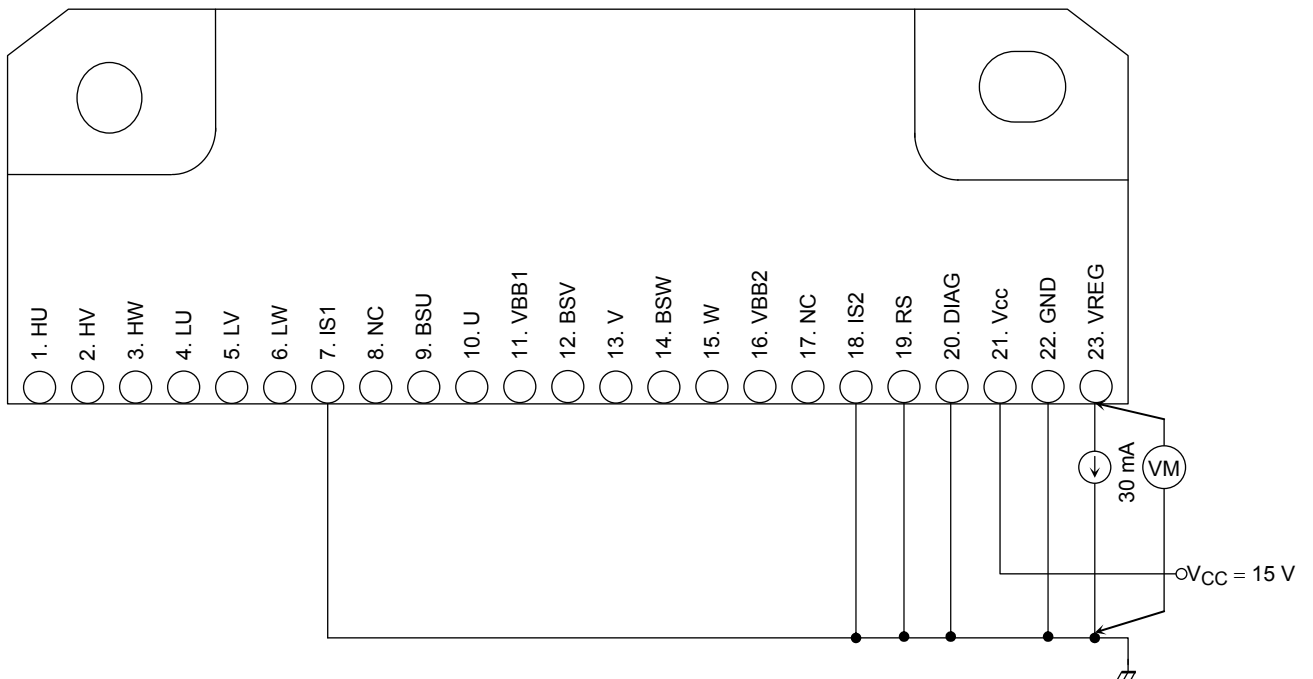

Output ON/OFF Delay Time (U-phase low side)

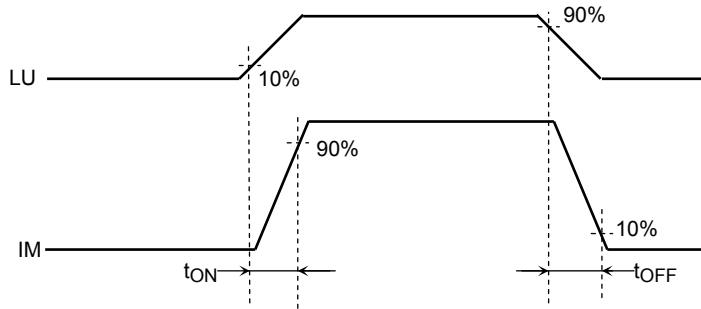
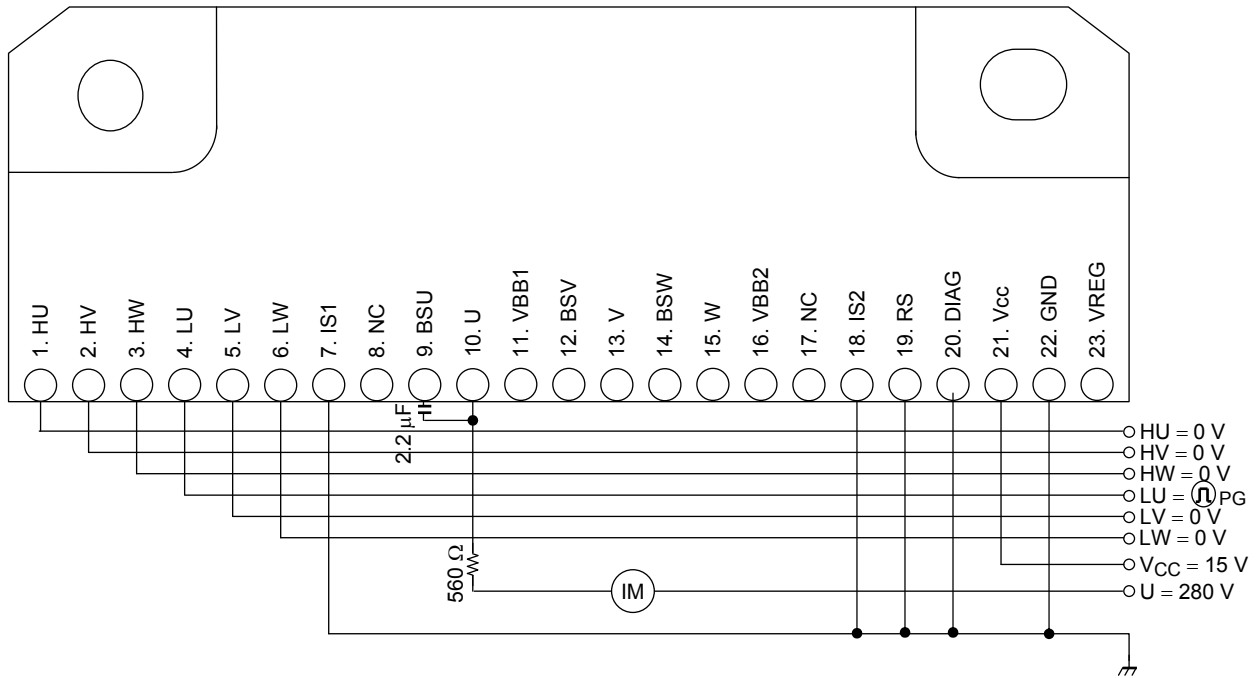

V_{CC} Under-voltage Protection Operation/Recovery Voltage (U-phase low side)

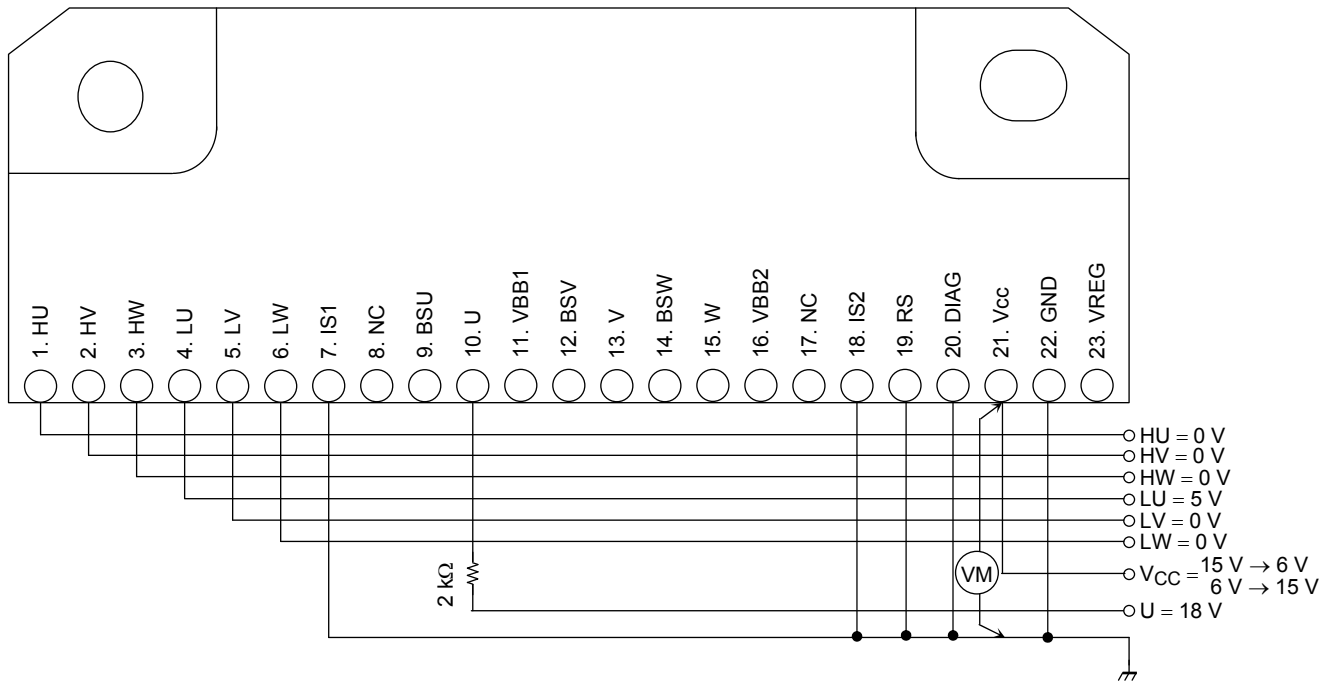

*:Note:Sweeps the V_{CC} pin voltage from 15 V and monitors the U pin voltage.
 The V_{CC} pin voltage when output is off defines the under-voltage protection operating voltage.
 Also sweeps from 6 V to increase. The V_{CC} pin voltage when output is on defines the under voltage protection recovery voltage.

V_{BS} Under-voltage Protection Operation/Recovery Voltage (U-phase high side)

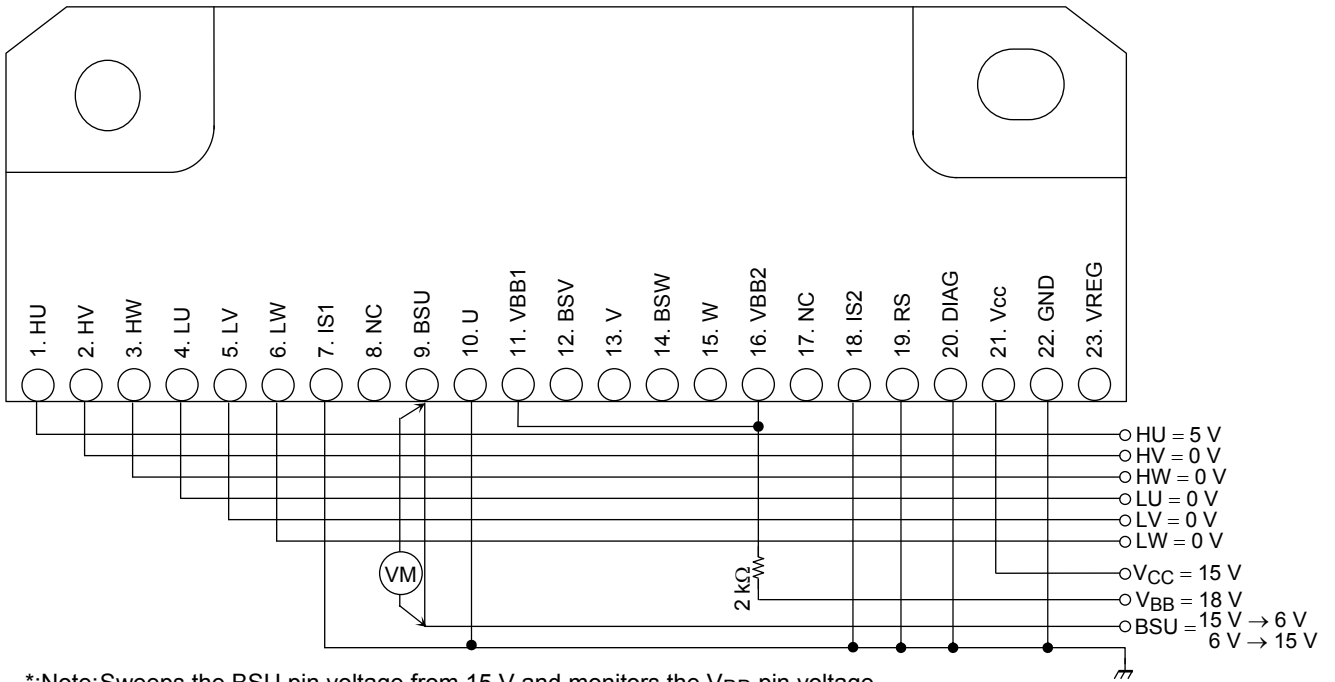

*:Note:Sweeps the BSU pin voltage from 15 V and monitors the V_{BB} pin voltage.
 The BSU pin voltage when output is off defines the under-voltage protection operating voltage.
 Also sweeps the BSU pin voltage from 6 V and changes from the HU pin voltage at 0 V → 5 V → 0 V.
 The BSU pin voltage when output is on defines the under-voltage protection recovery voltage.

Current Control Operating Voltage (U-phase high side)

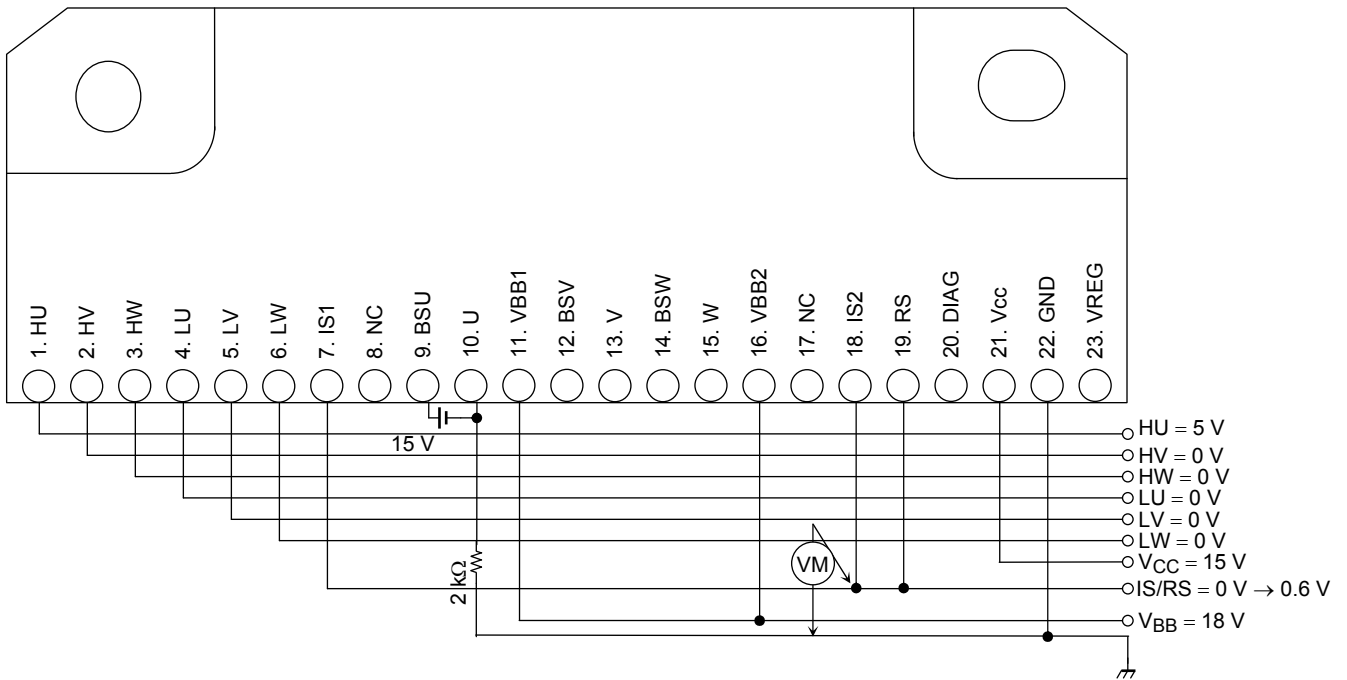

*: Note: Sweeps the IS/ RS pin voltage and monitors the U pin voltage.
 The IS/ RS pin voltage when output is off defines the current control operating voltage.

V_{BS} Current Consumption (U-phase high side)

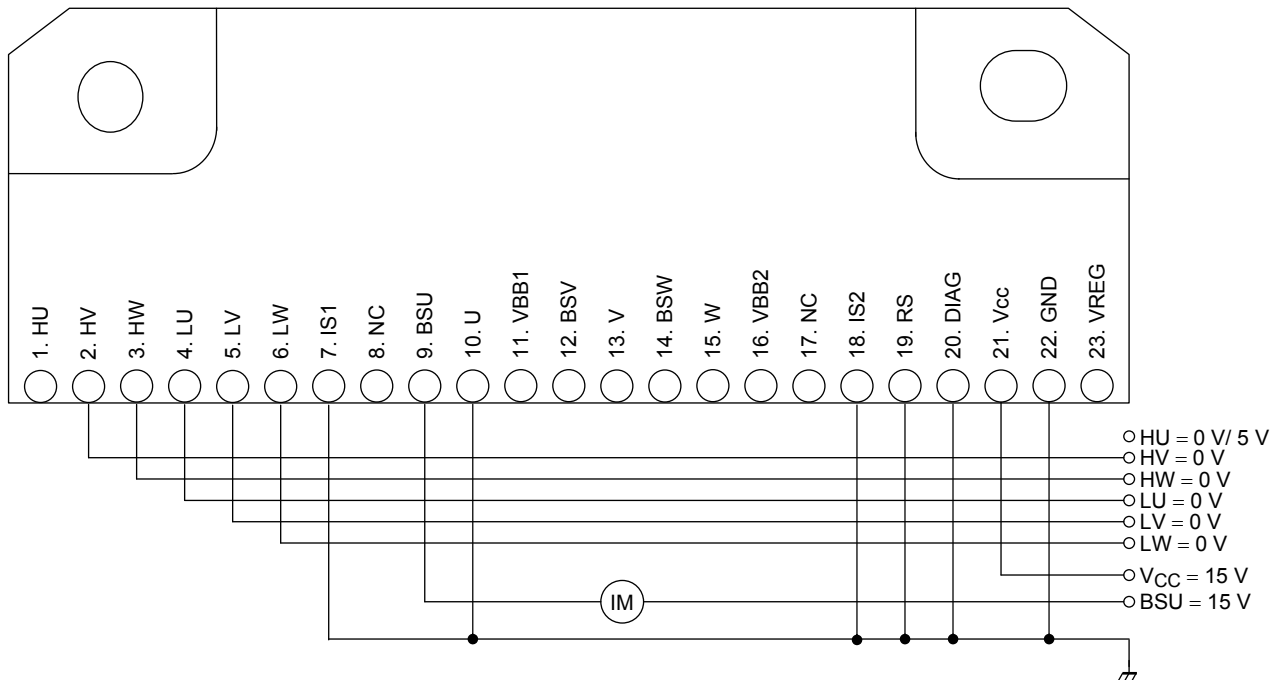

Turn-On/Off Loss (low-side IGBT + high-side FRD)

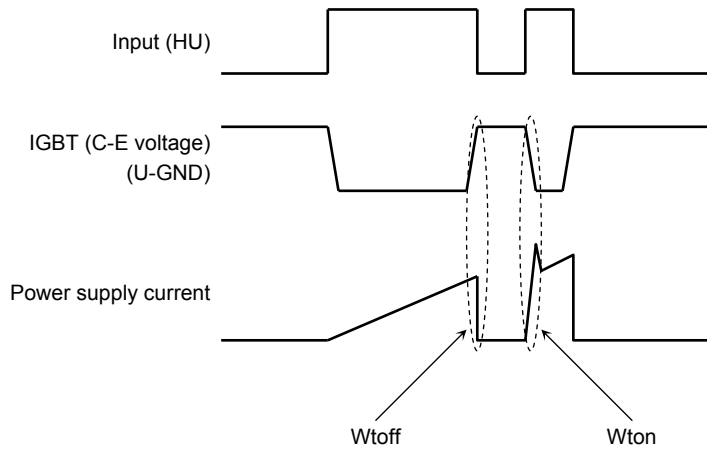
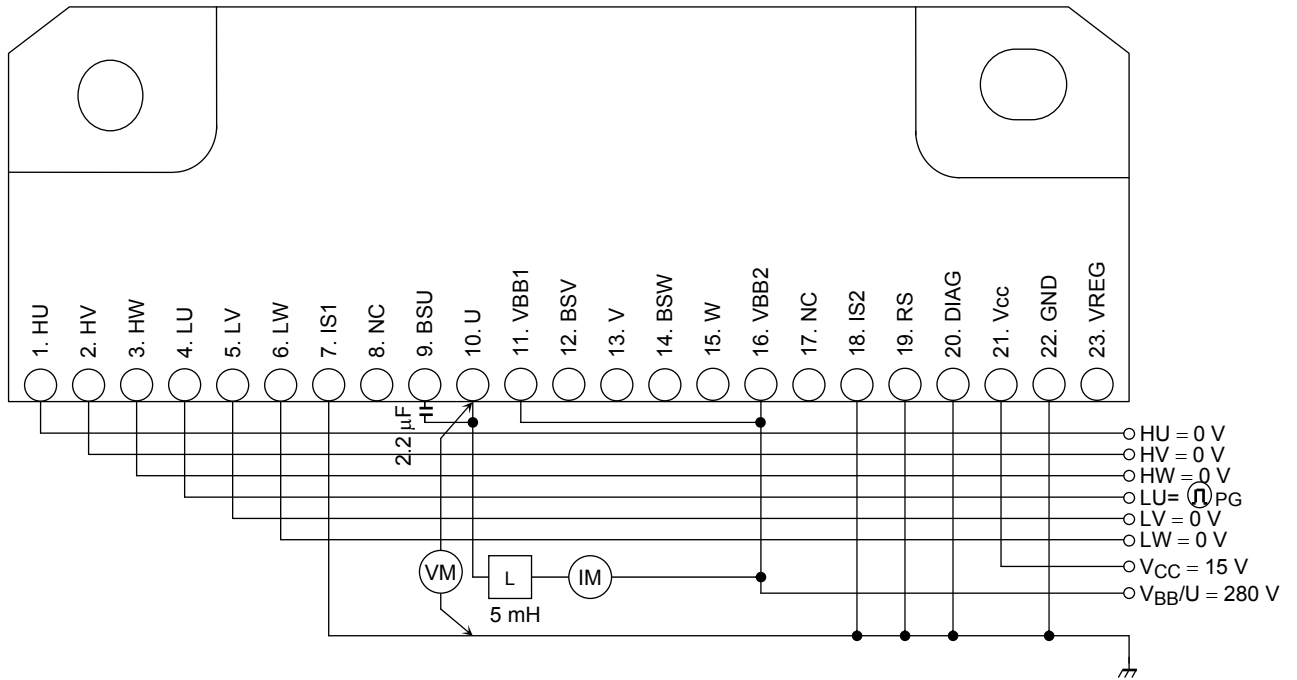

Package Dimensions

HZIP23-P-1.27F

Unit: mm

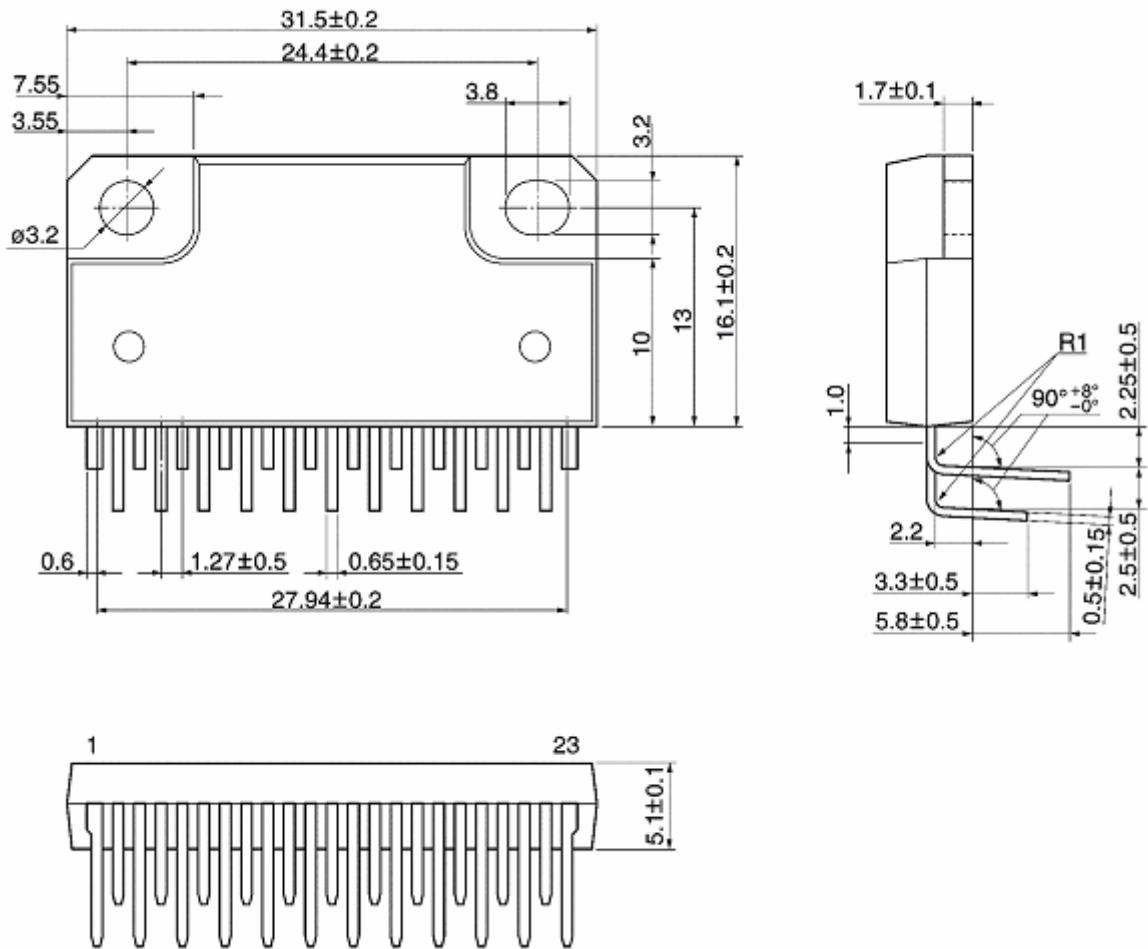

Weight: 6.1 g (typ.)

Package Dimensions

HZIP23-P-1.27G

Unit: mm

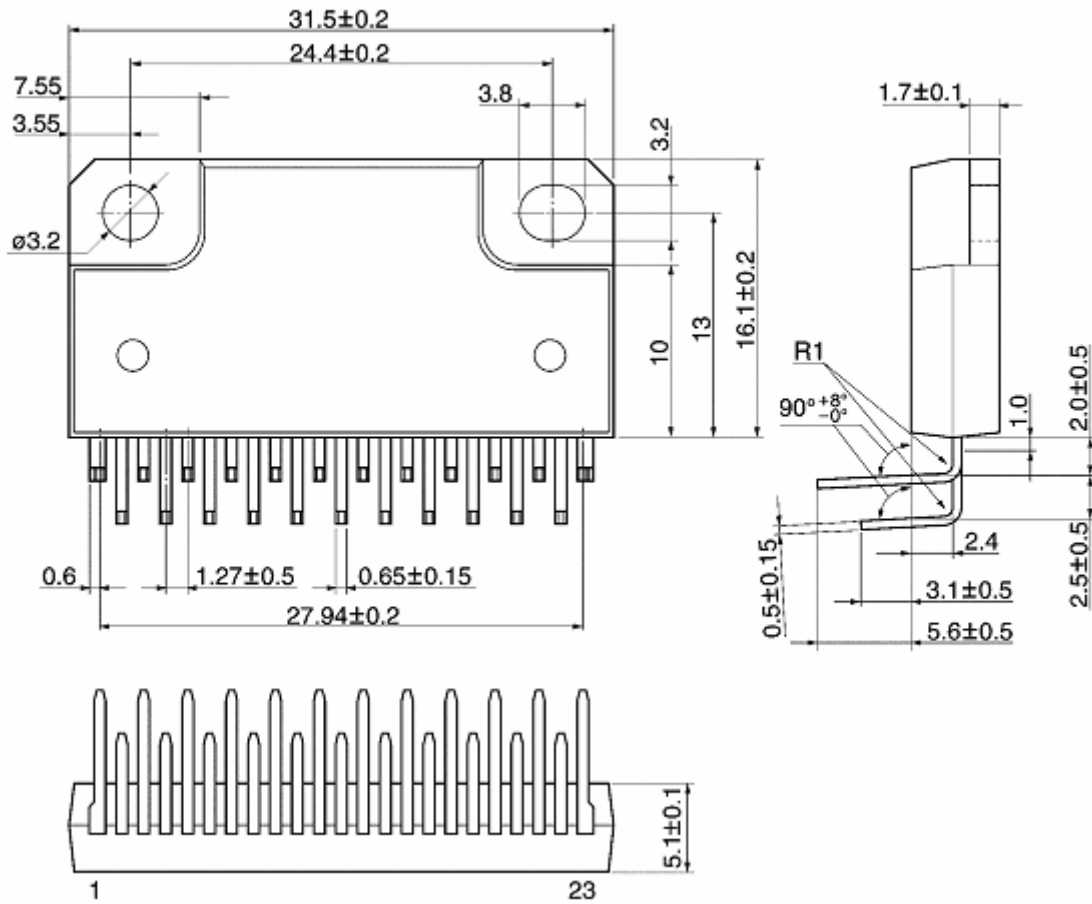

Weight: 6.1 g (typ.)

RESTRICTIONS ON PRODUCT USE

20070701-EN

- The information contained herein is subject to change without notice.
- TOSHIBA is continually working to improve the quality and reliability of its products. Nevertheless, semiconductor devices in general can malfunction or fail due to their inherent electrical sensitivity and vulnerability to physical stress. It is the responsibility of the buyer, when utilizing TOSHIBA products, to comply with the standards of safety in making a safe design for the entire system, and to avoid situations in which a malfunction or failure of such TOSHIBA products could cause loss of human life, bodily injury or damage to property.
In developing your designs, please ensure that TOSHIBA products are used within specified operating ranges as set forth in the most recent TOSHIBA products specifications. Also, please keep in mind the precautions and conditions set forth in the "Handling Guide for Semiconductor Devices," or "TOSHIBA Semiconductor Reliability Handbook" etc.
- The TOSHIBA products listed in this document are intended for usage in general electronics applications (computer, personal equipment, office equipment, measuring equipment, industrial robotics, domestic appliances, etc.). These TOSHIBA products are neither intended nor warranted for usage in equipment that requires extraordinarily high quality and/or reliability or a malfunction or failure of which may cause loss of human life or bodily injury ("Unintended Usage"). Unintended Usage include atomic energy control instruments, airplane or spaceship instruments, transportation instruments, traffic signal instruments, combustion control instruments, medical instruments, all types of safety devices, etc.. Unintended Usage of TOSHIBA products listed in this document shall be made at the customer's own risk.
- The products described in this document shall not be used or embedded to any downstream products of which manufacture, use and/or sale are prohibited under any applicable laws and regulations.
- The information contained herein is presented only as a guide for the applications of our products. No responsibility is assumed by TOSHIBA for any infringements of patents or other rights of the third parties which may result from its use. No license is granted by implication or otherwise under any patents or other rights of TOSHIBA or the third parties.
- Please contact your sales representative for product-by-product details in this document regarding RoHS compatibility. Please use these products in this document in compliance with all applicable laws and regulations that regulate the inclusion or use of controlled substances. Toshiba assumes no liability for damage or losses occurring as a result of noncompliance with applicable laws and regulations.