



TS39100/1/2/3

1.0A Ultra Low Dropout Positive Voltage Regulator

SOT-223**TO-252****TO-252-5L****SOP-8****Low Dropout Voltage 0.4V (typ.)****Enable Input Control****Adjustable Output****Error Flag Detection**

General Description

The TS39100/1/2/3 series are 1A ultra low dropout linear voltage regulators that provide low voltage, high current output from an extremely small package. These regulator offers extremely low dropout (typically 400mV at 1A) and very low ground current (typically 12mA at 1A).

The TS39100/1/2/3 series are fully protected against over current faults, reversed input polarity, reversed lead insertion, over temperature operation, positive and negative transient voltage spikes, logic level enable control and error flag which signals whenever the output falls out of regulation.

On the TS39101/2/3, the enable pin may be tied to Vin if it is not required for enable control. This series are offered in 3-pin SOT-223 (TS39100), 8-pin SOP (TS39101/2) and 5-pin TO-252 (TS39103) package.

Features

- ✧ Dropout voltage typically 0.4V @Io=1.0A
- ✧ Output current up to 1.0A
- ✧ Low ground current
- ✧ Output voltage trimmed before assembly
- ✧ Extremely fast transient response
- ✧ Reversed leakage protection
- ✧ Reverse battery protection
- ✧ Error flag signals output out of regulation
- ✧ Internal current limit
- ✧ Thermal shutdown protection

Ordering Information

| Part No. | Operating Temp. (Junction) | Package |
|-----------------------------|----------------------------|-----------|
| TS39100CW \underline{xx} | -40 ~ +125 °C | SOT-223 |
| TS39100CP \underline{xx} | | TO-252 |
| TS39101CS \underline{xx} | | SOP-8 |
| TS39102CS | | TO-252-5L |
| TS39103CP5 \underline{xx} | | |

Note: Where \underline{xx} denotes voltage option, available are 5.0V, 3.3V, 2.5V, 1.8V and 1.5V. Leave blank for adjustable version (only TS39103). Contact to factory for addition output voltage option.

Applications

- ✧ Battery power equipment
- ✧ LDO linear regulator for PC add-in cards
- ✧ PowerPC™ power supplies
- ✧ Multimedia and PC processor supplies
- ✧ High efficiency linear power supplies
- ✧ High efficiency post regulator for switching supply
- ✧ Low-voltage microcontrollers and digital logic
- ✧ SMPS post regulator

Absolute Maximum Rating (Note 1)

| | | | |
|-------------------------------------|------------------|------------|----|
| Supply Voltage | Vin | -20V ~ +20 | V |
| Enable Voltage | Ven | +20 | V |
| Storage Temperature Range | T _{STG} | -65 ~ +150 | °C |
| Lead Soldering Temperature (260 °C) | | 5 | S |
| ESD | | (Note 3) | |



| Operating Rating (Note 2) | | | | | | |
|--|---------------------------------------|----------|--------------------|------|----------|--------|
| Operation Input Voltage | Vin (operate) | | +2.25 ~ +16 | V | | |
| Operation Enable Voltage | Ven (operate) | | +2.25 ~ +16 | V | | |
| Power Dissipation (Note 4) | PD | | Internally Limited | W | | |
| Operating Junction Temperature Range | Tj | | -40 ~ +125 | °C | | |
| Electrical Characteristics | | | | | | |
| Vin = Vout + 1V, Venable= 2.25V, Tj = 25 °C, unless otherwise specified. | | | | | | |
| Parameter | Conditions | | Min | Typ | Max | Unit |
| Output Voltage | IL=10mA | | 0.990 Vo | Vout | 1.010 Vo | V |
| Output Voltage | 10mA ≤ IL ≤ 1.0A, Vo+1V ≤ Vin ≤ 8V | | 0.980 Vo | | 1.020 Vo | |
| Line Regulation | IL=10mA, Vo+1V ≤ Vin ≤ 16V | | -- | 0.05 | 0.5 | % |
| Load Regulation | Vin=Vout+1V, 10mA ≤ IL ≤ 1A | | -- | 0.2 | 1.0 | % |
| Output Voltage Temp. Coefficient | | | -- | 40 | 100 | ppm/°C |
| Dropout Voltage (Note 5) | ΔVout= -1% | IL=100mA | -- | 100 | 250 | mV |
| | | IL=500mA | -- | 275 | | |
| | | IL=750mA | -- | 350 | 500 | |
| | | IL=1.0A | -- | 400 | 630 | |
| Quiescent Current (Note 6) | Vin=Vout+1V | IL=100mA | -- | 0.7 | -- | mA |
| | | IL=500mA | -- | 4.0 | -- | |
| | | IL=750mA | -- | 7.0 | -- | |
| | | IL=1.0A | -- | 12.0 | 20 | |
| Current Limited | Vout=0, Vin=Vout+1V | | -- | 1.8 | 2.5 | A |
| Reference (TS39102) | | | | | | |
| Reference Voltage | | | 0.980 Vo | 1.24 | 1.020 Vo | V |
| Reference Voltage | (Note 7) | | 0.970 Vo | | 1.030 Vo | |
| Adjust Pin Bias Current | | | -- | 40 | 120 | nA |
| Reference Voltage Temp. Coefficient | (Note 8) | | -- | 20 | -- | ppm/°C |
| Adjust Pin Bias Current Temp. Coefficient | | | -- | 0.1 | -- | nA/°C |
| Flag Output (TS39101) | | | | | | |
| Output Leakage Current | VOH=16V | | -- | -- | 2 | uA |
| Output Low Voltage (Note 9) | Vin=0.9 * Vout, IOL=250uA | | -- | -- | 400 | mV |
| Upper Threshold Voltage | % of Vout | | -- | -- | 99 | % |
| Lower Threshold Voltage | % of Vout | | 93 | -- | -- | % |
| Hysteresis | | | -- | 1 | -- | % |
| Enable Input (TS39101 / 2 / 3) | | | | | | |
| Input Logic Voltage | Low (OFF) | | -- | -- | 0.8 | V |
| | High (ON) | | 2.25 | -- | -- | |
| Enable Pin Input Current | Ven=2.25V | | -- | -- | 75 | uA |
| | Ven=0.8V | | -- | -- | 4 | |



Thermal Performance

| Condition | Package type | Typ | Unit |
|---|--------------|-----|------|
| Thermal Resistance Junction to Ambient | SOT-223 | 15 | °C/W |
| | SOP-8 | 20 | |
| | TO-252 | 25 | |

Note 1: Absolute Maximum Rating is limits beyond which damage to the device may occur. For guaranteed specifications and test conditions see the Electrical Characteristics.

Note 2: The device is not guaranteed to operate outside its operating rating.

Note 3: Devices are ESD sensitive. Handling precautions recommended.

Note 4: The maximum allowable power dissipation is a function of the maximum junction temperature, T_j , the junction to ambient thermal resistance, θ_{ja} , and the ambient temperature, T_a . Exceeding the maximum allowable power dissipation will cause excessive die temperature, and the regulator will go into thermal shutdown. The effective value of θ_{ja} can be reduced by using a heatsink, $P_{d(max)} = (T_{j(max)} - T_a) / \theta_{ja}$.

Note 5: Dropout voltage is defined as the input to output differential at which the output voltage drops -1% below its nominal value measured at 1V differential.

Note 6: Ground pin current is the regulator quiescent current. The total current drawn from the source is the sum of the ground pin current and output load current, $I_{in} = I_{gnd} + I_{out}$.

Note 7: $V_{ref} \leq V_{out} \leq (V_{in} - 1V)$, $2.25V \leq V_{in} \leq 16V$, $10mA \leq I_L \leq 1.0A$.

Note 8: Output voltage temperature coefficient is $\Delta V_{out} \text{ (worse cast)} / (T_{j(max)} - T_{j(min)})$ where is $T_{j(max)}$ +125 °C and $T_{j(min)}$ is 0 °C.

Note 9: For adjustable device and fixed device with $V_{out} > 2.25V$.

Block Diagram

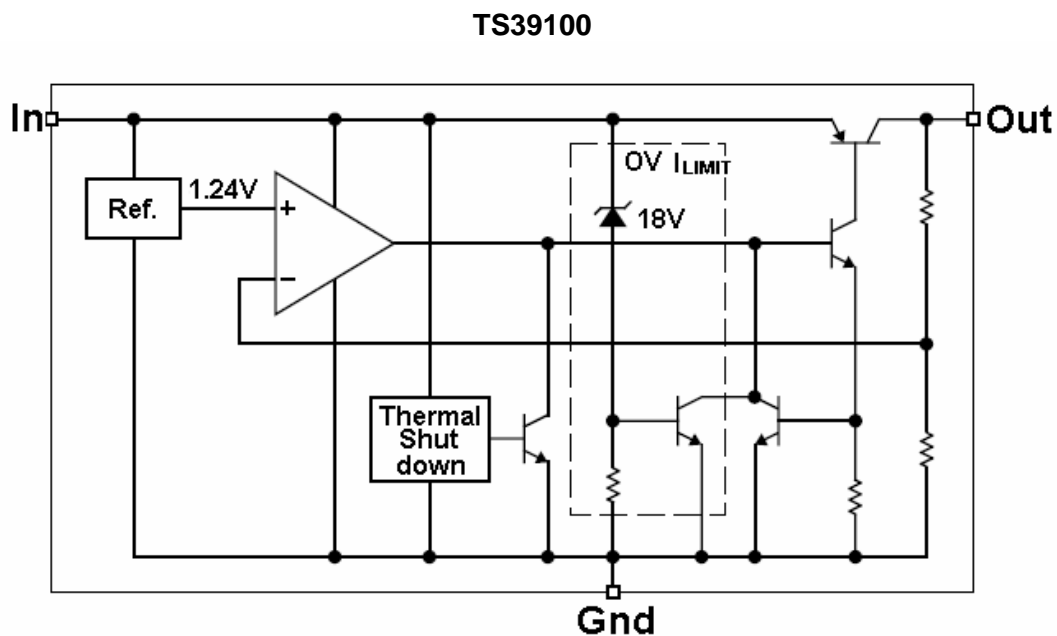

Block Diagram

TS39101 & TS39102 & TS39103

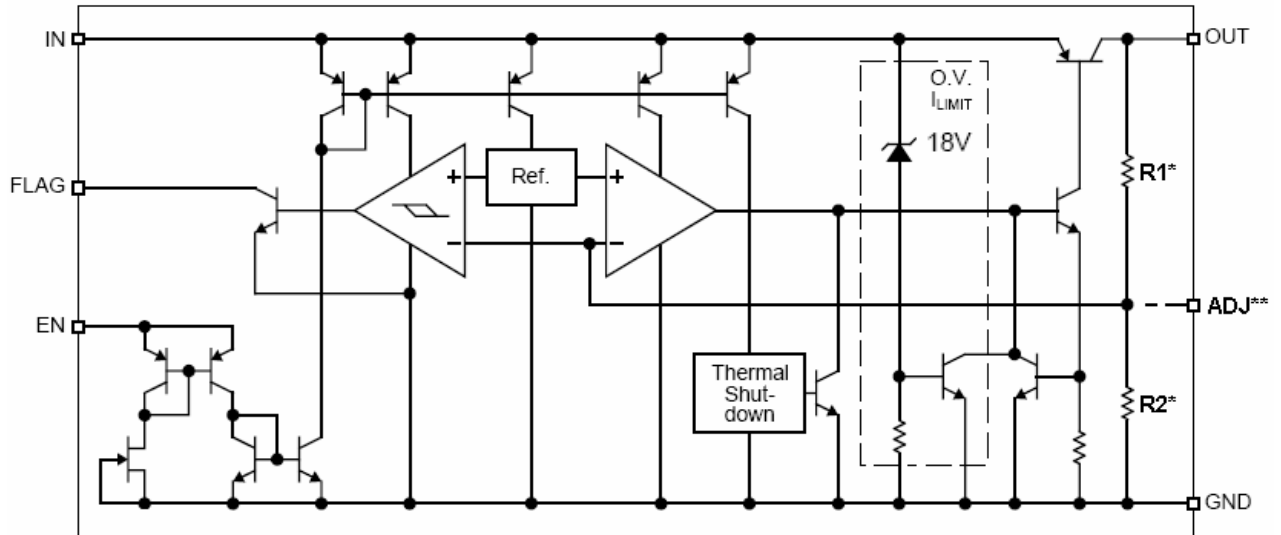

* Feedback network is fixed output versions only (TS39101CSxx & TS39103CP5xx)

** Adjustable output version only (TS39102CS & TS39103CP5)



Pin Assignment

| Pin No. | | | | Pin Configuration | Pin Description |
|---------|---------|---------|---------|-----------------------------------|---|
| TS39100 | TS39101 | TS39102 | TS39103 | | |
| | 1 | 1 | 1 | Enable | Enable (input): TTL/COMS compatible input. Logic high is enable; logic low or open is shutdown |
| 1 | 2 | 2 | 2 | Input | Unregulated input: +26V maximum supply |
| 2 | 5,6,7,8 | 5,6,7,8 | 3 | Ground | Ground: Ground pin and TAB/heatsink are internally connected. |
| 3 | 3 | 3 | 4 | Output | Regulator output |
| | 4 | | 5 | Flag (fixed output voltage) | Error Flag (output): Open-collector output. Active low indicates an output fault condition, if no used, leave open. |
| | | 4 | | Feed Back (adjustable voltage) | Adjustment input: Feedback input. Connect to resistive voltage-divider network. |

Typical Application Circuit

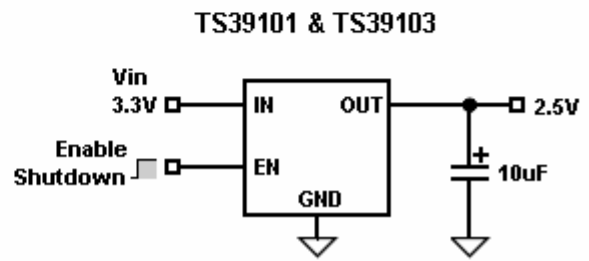
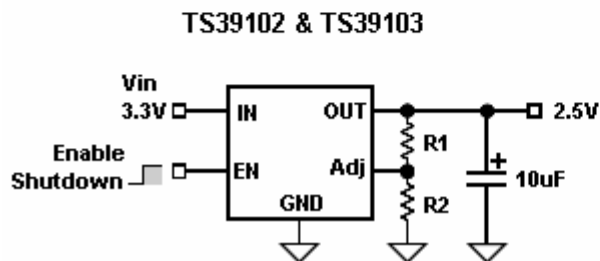
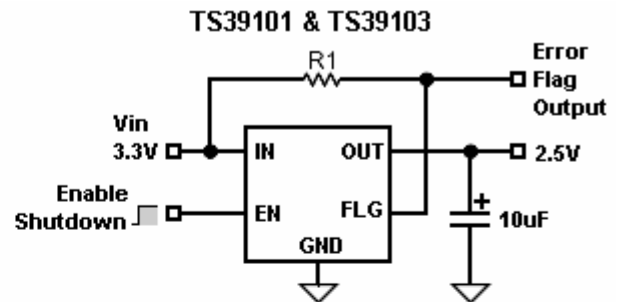
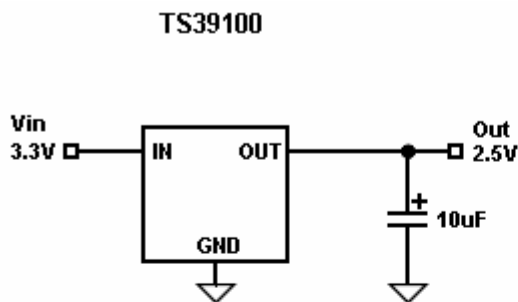



Application Information

Application Information

The TS39100/1/2/3 series are high performance with low dropout voltage regulator suitable for moderate to high current and voltage regulator application. Its 630mV dropout voltage at full load and over temperature makes it especially valuable in battery power systems and as high efficiency noise filters in post regulator applications. Unlike normal NPN transistor design, where the base to emitter voltage drop and collector to emitter saturation voltage limit the minimum dropout voltage, dropout performance of the PNP output of these devices is limited only by low V_{ce} saturation voltage.

The TS39100/1/2/3 series is fully protected from damage due to fault conditions. Linear current limiting is provided. Output current during overload conditions is constant. Thermal shutdown the device when the die temperature exceeds the maximum safe operating temperature. Transient protection allows device survival even when the input voltage spikes above and below nominal. The output structure of these regulators allows voltages in excess of the desired output voltage to be applied without reverse current flow.

Output Capacitor Requirement

The TS39100/1/2/3 series requires an output capacitor to maintain stability and improve transient response is necessary. The value of this capacitor is dependent upon the output current, lower currents allow smaller capacitors. TS39100/1/2/3 series output capacitor selection is dependent upon the ESR of the output capacitor to maintain stability. When the output capacitor is 10uF or greater, the output capacitor should have an ESR less than 2Ω . This will improve transient response as well as promote stability. Ultra low ESR capacitors ($<100m\Omega$), such as ceramic chip capacitors, may promote instability. These very low ESR levels may cause an oscillation and/or under damped transient response. A low ESR solid tantalum capacitor works extremely well and provides good transient response and stability over temperature aluminum electrolytes can also be used, as long as the ESR of the capacitor is $<2\Omega$.

The value of the output capacitor can be increased without limit. Higher capacitance values help to improve transient response and ripple rejection and reduce output noise.

Input Capacitor Requirement

An input capacitor of 1uF or greater is recommended when the device is more than 4" away from the bulk AC supply capacitance or when the supply is a battery. Small, surface mount, ceramic chip capacitors can be used for bypassing. Larger values will help to improve ripple rejection by bypassing the input to the regulator, further improving the integrity of the output voltage.

Minimum Load Current

The TS39100/1/2/3 series is specified between finite loads. If the output current is too small leakage currents dominate and the output voltage rises. A 10mA minimum load current is necessary for proper regulation.

Adjustable Regulator Design

The adjustable regulator versions (TS39102) allow to programming the output voltage anywhere between 1.25 and the 16V maximum operating rating of the family.

Two resistors are used. Resistors can be quite large up to $1M\Omega$, because of the very high input impedance and low bias current of the sense comparator, the resistor values are calculated by:

$$R1 = R2 * [(V_{out} / 1.24) - 1]$$

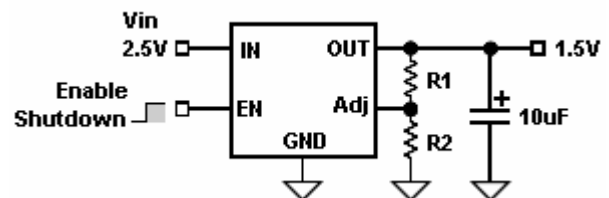

Where V_{out} is the desired output voltage. Above application circuit shows component definition. Applications with widely varying load currents may scale the resistors to draw the minimum load current required for proper operation.

Application Information (continues)

Error Flag

TS39101 versions feature an Error Flag, which looks at the output voltage and signals an error condition when this voltage drops 5% below its expected value. The error flag is an open-collector output that pulls low under fault conditions. It may sink 10mA. Low output voltage signifies a number of possible problems, including an over-current fault (the device is in current limit) or low input voltage. The flag output is inoperative during over temperature shutdown conditions. A pull-up resistor from error flag to either V_{in} or V_{out} is required for proper operation. For information regarding the minimum and maximum values of pull-up resistance, refer the graph as follow:

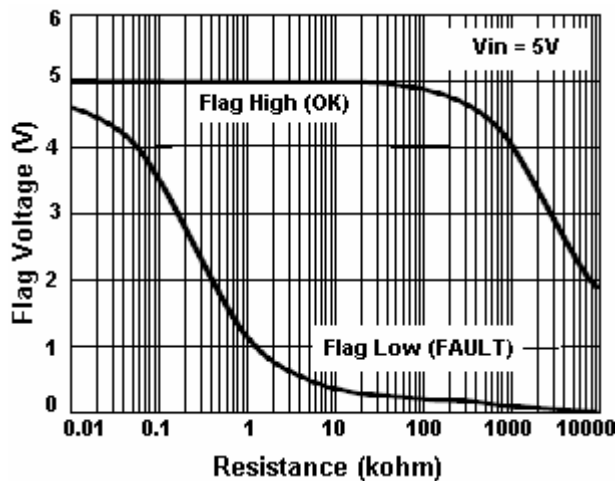

Enable Input

TS39101/2/3 versions feature an active-high enable (EN) input that allows ON/OFF control of the regulator. Current drain reduces to “zero” when the device is shutdown, with only micro-amperes of leakage current. The EN input has TTL/CMOS compatible thresholds for simple interfacing with logic interfacing. EN may be directly tied to V_{in} and pulled up to the maximum supply voltage.

Transient Response and 3.3V to 2.5V or 2.5V to 1.8V Conversion

TS39101/2/3 has excellent transient response to variations in input voltage and load current. The device have been designed to respond quickly to load current variations and input voltage variations.

Large output capacitors are not required to obtain this performance. A standard 10uF output capacitor, preferably tantalum, is all that is required. Larger values help to improve performance even further.

By virtue of its low dropout voltage, this device does not saturate into dropout as readily as similar NPN base designs. When converting from 3.3V to 2.5V or 2.5V to 1.8V, the NPN based regulators are already operating in dropout, with typical dropout requirements of 1.2V or greater. To convert down to 2.5V or 1.8V without operating in dropout, NPN based regulators require an input voltage of 3.7V at the very least.

The TS39100 regulator will provide excellent performance with an input as low as 3.0V or 2.5V respectively. This gives the PNP based regulators a distinct advantage over older, NPN based linear regulators.

Power SOP-8 Thermal Characteristics

TS39101/2 series' performance is its power SOP-8 package featuring half the thermal resistance of a standard SOP-8 package. Lower thermal resistance means more output current or higher input voltage for a given package size.

Lower thermal resistance is achieved by connect the four ground pins with the die attached pad to create a single piece electrical and thermal conductor. This concept have been used by MOSFET production for years, proving very reliable and cost effective for the user. As under:

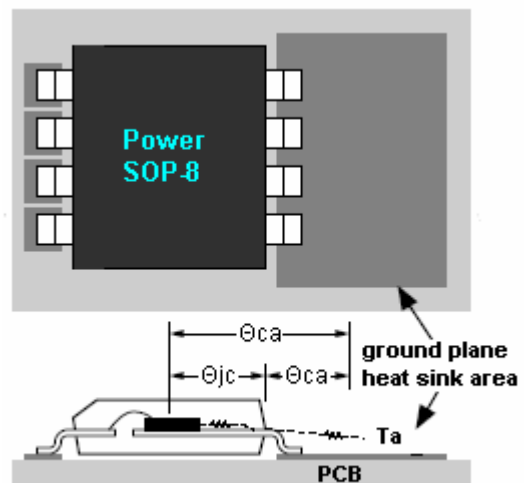

Thermal Resistance

Application Information (continues)

Thermal resistance consists of two main elements, Θ_{jc} (junction to case) and Θ_{ca} (case to ambient). Using the power SOP-8 reduces Θ_{ca} , the total thermal resistance, Θ_{ja} (junction to ambient) is the limiting factor in calculating the maximum power dissipation capability of the device. Typically, the power SOP-8 have a Θ_{jc} of $20^{\circ}\text{C}/\text{W}$ dramatically, this is significantly lower than the standard SOP-8 which is typically $75^{\circ}\text{C}/\text{W}$. Θ_{ca} is reduced because pin 5~8 can be soldered directly to a ground plane which significantly reduces the case to sink and sink to ambient thermal resistance.

Power Dissipation

From under curves, the minimum area of copper necessary for the part to operate safely can be determined. The maximum allowable temperature rise must be calculated to determine operation along which curve.

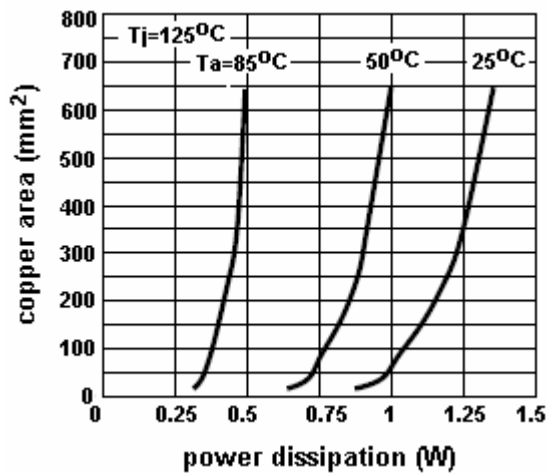

SOT-223 Mechanical Drawing

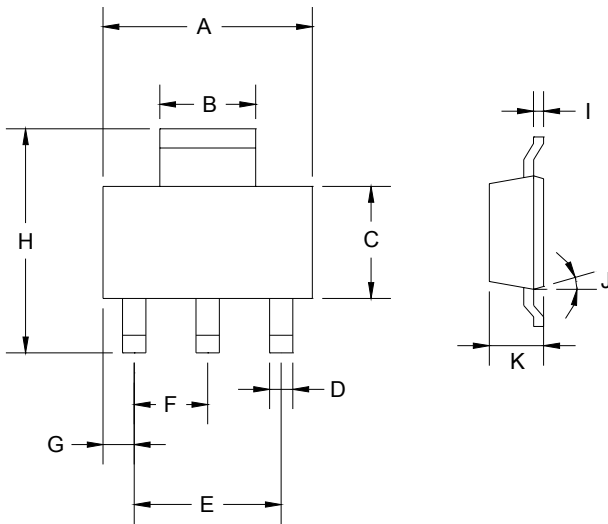

| SOT-223 DIMENSION | | | | |
|-------------------|-------------|-------|--------|-------|
| DIM | MILLIMETERS | | INCHES | |
| | MIN | MAX | MIN | MAX |
| A | 6.350 | 6.850 | 0.250 | 0.270 |
| B | 2.900 | 3.100 | 0.114 | 0.122 |
| C | 3.450 | 3.750 | 0.136 | 0.148 |
| D | 0.595 | 0.635 | 0.023 | 0.025 |
| E | 4.550 | 4.650 | 0.179 | 0.183 |
| F | 2.250 | 2.350 | 0.088 | 0.093 |
| G | 0.835 | 1.035 | 0.032 | 0.041 |
| H | 6.700 | 7.300 | 0.263 | 0.287 |
| I | 0.250 | 0.355 | 0.010 | 0.014 |
| J | 10° | 16° | 10° | 16° |
| K | 1.550 | 1.800 | 0.061 | 0.071 |

TO-252 Mechanical Drawing

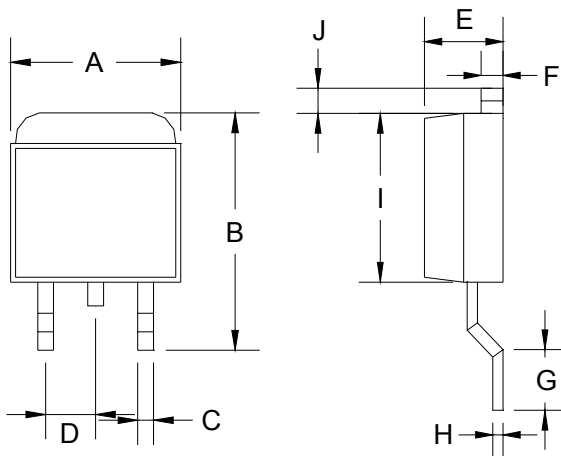

| TO-252 DIMENSION | | | | |
|------------------|-------------|--------|--------|-------|
| DIM | MILLIMETERS | | INCHES | |
| | MIN | MAX | MIN | MAX |
| A | 6.570 | 6.840 | 0.259 | 0.269 |
| B | 9.250 | 10.400 | 0.364 | 0.409 |
| C | 0.550 | 0.700 | 0.022 | 0.028 |
| D | 2.560 | 2.670 | 0.101 | 0.105 |
| E | 2.300 | 2.390 | 0.090 | 0.094 |
| F | 0.490 | 0.570 | 0.019 | 0.022 |
| G | 1.460 | 1.580 | 0.057 | 0.062 |
| H | 0.520 | 0.570 | 0.020 | 0.022 |
| I | 5.340 | 5.550 | 0.210 | 0.219 |
| J | 1.460 | 1.640 | 0.057 | 0.065 |

SOP-8 Mechanical Drawing

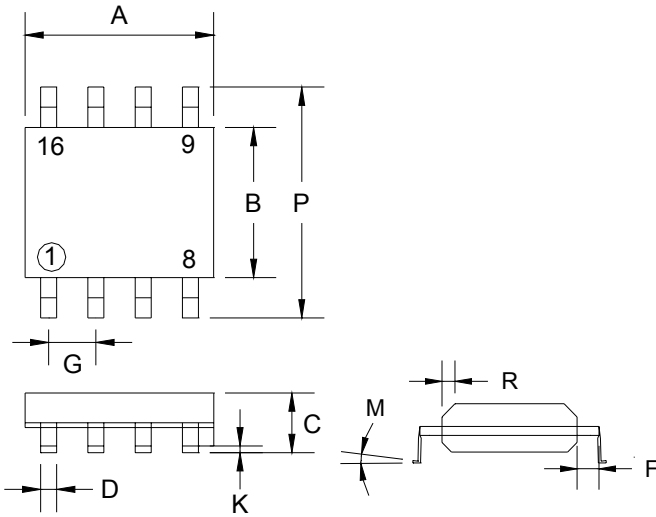

| SOP-8 DIMENSION | | | | |
|-----------------|-------------|------|------------|-------|
| DIM | MILLIMETERS | | INCHES | |
| | MIN | MAX | MIN | MAX |
| A | 4.80 | 5.00 | 0.189 | 0.196 |
| B | 3.80 | 4.00 | 0.150 | 0.157 |
| C | 1.35 | 1.75 | 0.054 | 0.068 |
| D | 0.35 | 0.49 | 0.014 | 0.019 |
| F | 0.40 | 1.25 | 0.016 | 0.049 |
| G | 1.27 (typ) | | 0.05 (typ) | |
| K | 0.10 | 0.25 | 0.004 | 0.009 |
| M | 0° | 7° | 0° | 7° |
| P | 5.80 | 6.20 | 0.229 | 0.244 |
| R | 0.25 | 0.50 | 0.010 | 0.019 |

TO-252-5L Mechanical Drawing

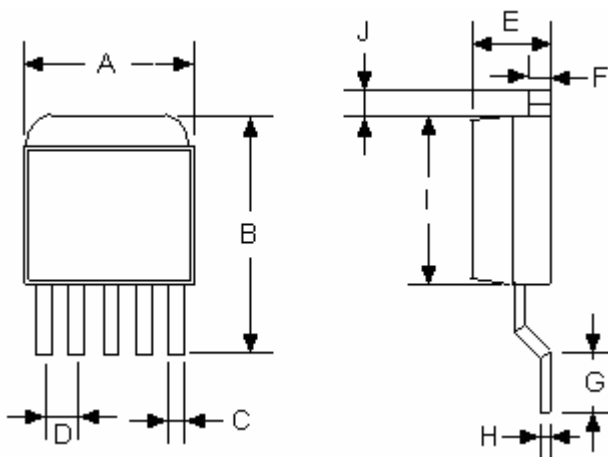

| TO-252-5L DIMENSION | | | | |
|---------------------|-------------|-------|----------|-------|
| DIM | MILLIMETERS | | INCHES | |
| | MIN | MAX | MIN | MAX |
| A | 6.350 | 6.730 | 0.2509 | 0.265 |
| B | 9.080 | 10.44 | 0.357 | 0.411 |
| C | 0.460 | 0.640 | 0.018 | 0.025 |
| D | 1.27BSC | | 0.050BSC | |
| E | 2.190 | 2.380 | 0.086 | 0.094 |
| F | 0.460 | 0.570 | 0.018 | 0.022 |
| G | 1.400 | 1.780 | 0.055 | 0.070 |
| H | 0.460 | 0.570 | 0.018 | 0.022 |
| I | 5.340 | 5.550 | 0.210 | 0.219 |
| J | 1.520 | 2.030 | 0.060 | 0.080 |