

**Description**

- High speed switching application.
- Analog switch application.

**Features**

- -2.5V Gate drive.
- Low threshold voltage :  $V_{th} = -0.5 \sim -1.5V$ .
- High speed.

**Ordering Information**

Type NO.	Marking	Package Code
STJ828UF	J28	SOT-323F

**Outline Dimensions**

unit : mm

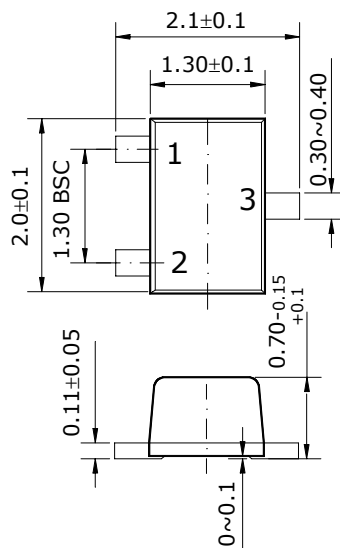

**PIN Connections**

1. Gate
2. Source
3. Drain

## Absolute maximum ratings

(Ta=25°C)

Characteristic	Symbol	Ratings	Unit
Drain-Source voltage	$V_{DS}$	-20	V
Gate-Source voltage	$V_{GSS}$	$\pm 7$	V
DC Drain current	$I_D$	-50	mA
Drain Power dissipation	$P_D$	150	mW
Channel temperature	$T_{ch}$	150	°C
Storage temperature range	$T_{stg}$	-55~150	°C

## Electrical Characteristics

(Ta=25°C)

Characteristic	Symbol	Test Condition	Min.	Typ.	Max.	Unit
Drain-Source breakdown voltage	$BV_{DSS}$	$I_D = -100\mu A, V_{GS} = 0$	-20			V
Gate-Threshold voltage	$V_{th}$	$I_D = -0.1mA, V_{DS} = -3V$	-0.5		-1.5	V
Drain cut-off current	$I_{DSS}$	$V_{DS} = -20V, V_{GS} = 0$			-1	$\mu A$
Gate leakage current	$I_{GSS}$	$V_{GS} = \pm 7V, V_{DS} = 0$			$\pm 1$	$\mu A$
Drain-Source on-resistance	$R_{DS(ON)}$	$V_{GS} = -2.5V, I_D = -10mA$			40	$\Omega$
Forward transfer admittance	$ Y_{fs} $	$V_{DS} = -3V, I_D = -10mA$	15			mS
Input capacitance	$C_{iss}$	$V_{DS} = -3V, V_{GS} = 0, f = 1MHz$		10.4		pF
Output capacitance	$C_{oss}$	$V_{DS} = -3V, V_{GS} = 0, f = 1MHz$		8.4		pF
Reverse Transfer capacitance	$C_{rss}$	$V_{DS} = -3V, V_{GS} = 0, f = 1MHz$		2.8		pF
Turn-on time	$t_{ON}$	$V_{DD} = -3V, I_D = -10mA$ $V_{GEN} = 0 \sim -2.5V$		0.15		$\mu s$
Turn-off time	$t_{OFF}$	$V_{DD} = -3V, I_D = -10mA$ $V_{GEN} = 0 \sim -2.5V$		0.13		$\mu s$

\*. Switching Time Test Circuit

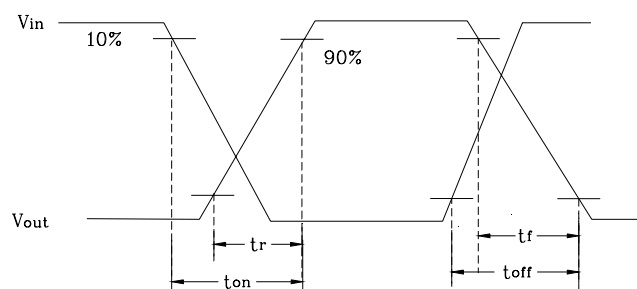
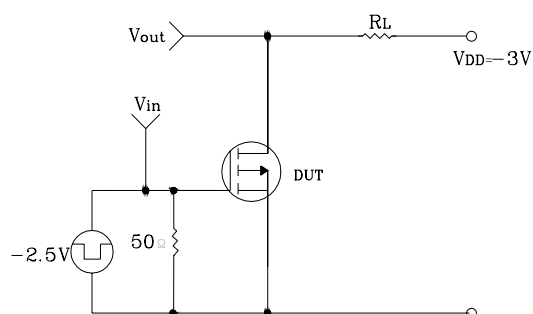

Electrical Characteristic Curves

Fig1 Id - Vds

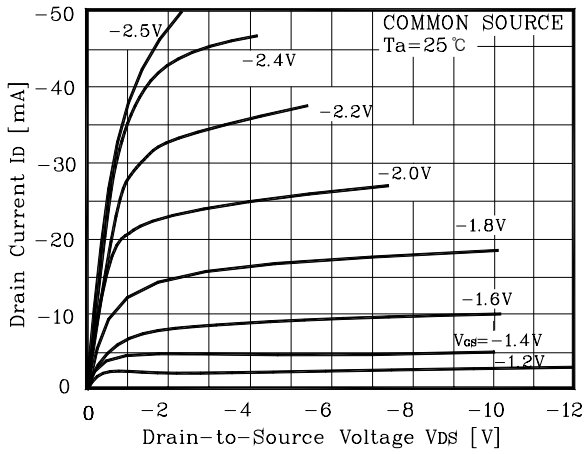

Fig2 Id - Vds

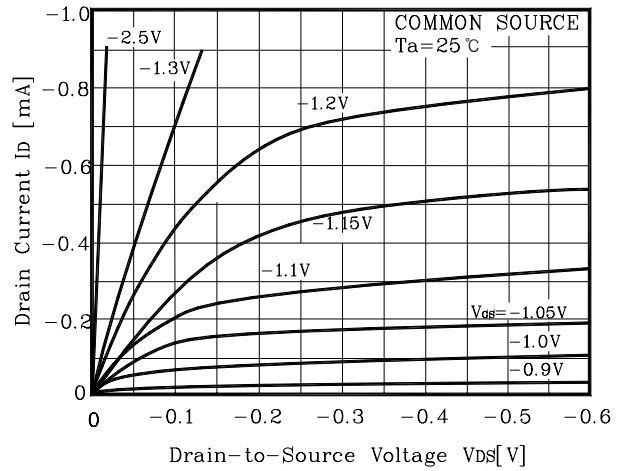

Fig3 IDR - Vds

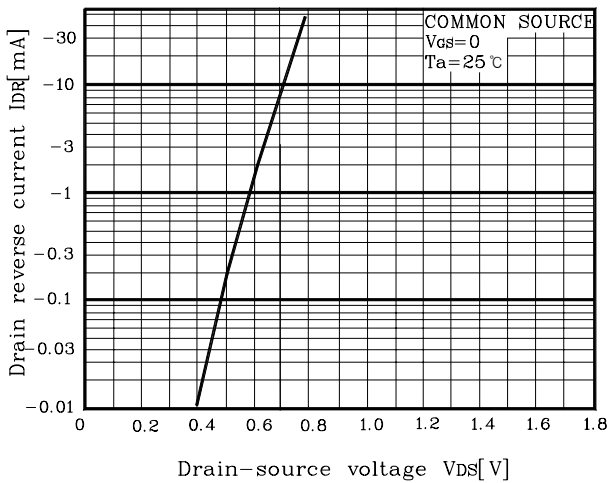

Fig4 Id - Vgs

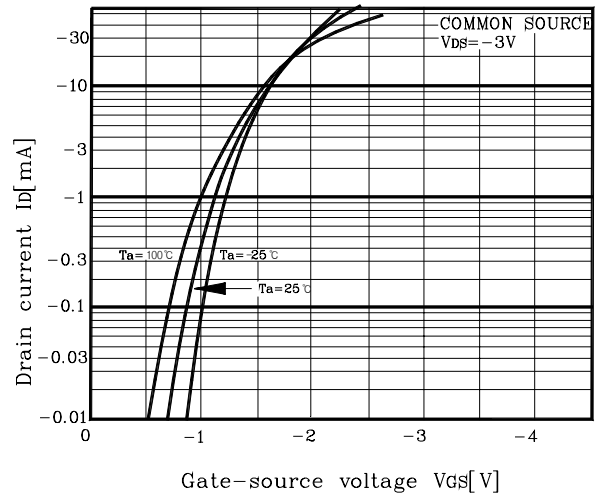

Fig5 | Yfs | - Id

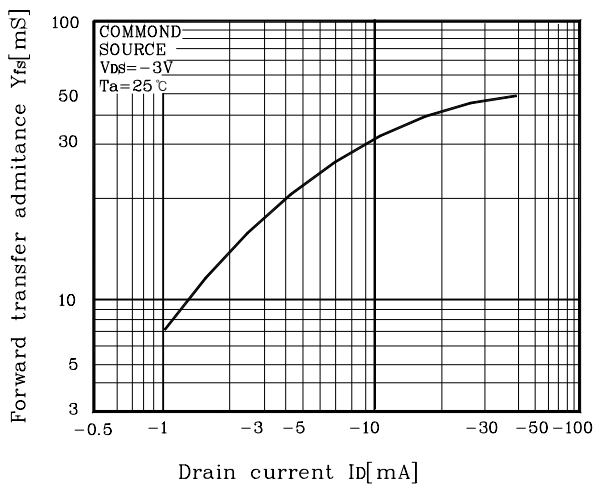
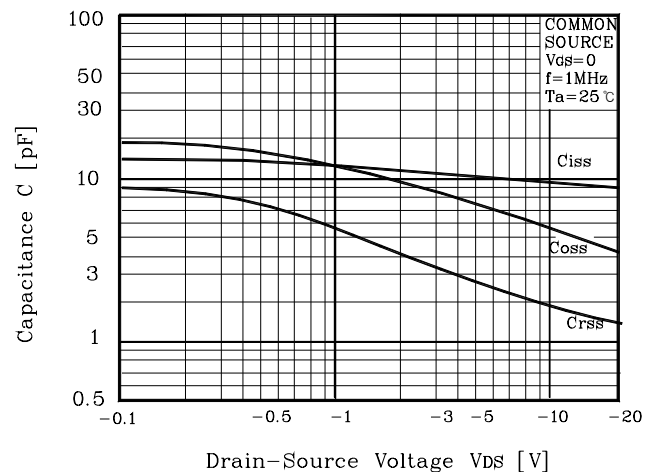
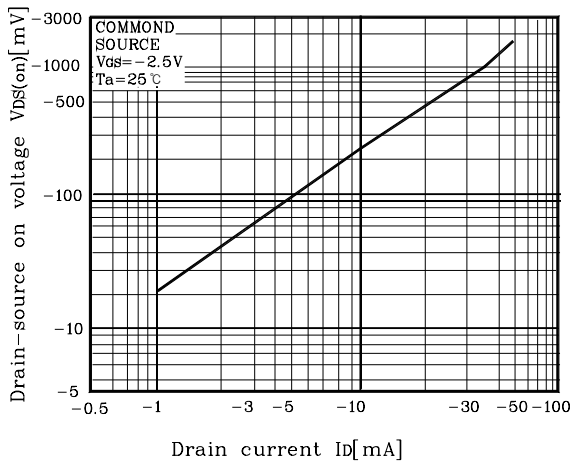

Fig6 C - Vds



**Fig7 VDS(on) - Id**



**Fig8 t - Id**

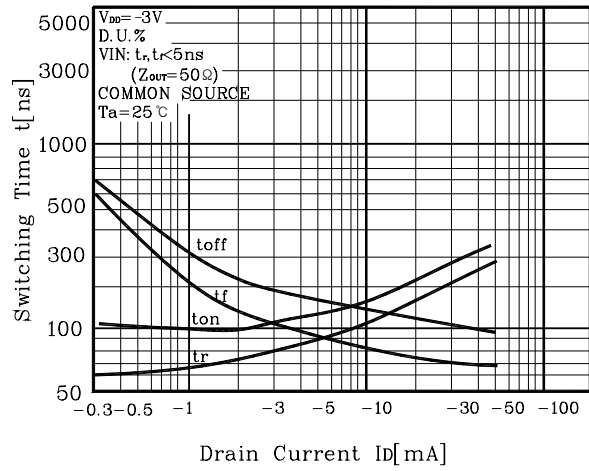

**Fig9 Pd - Ta**

