

# SC311 (0.5A)

( 400V to 600V / 0.5A )

## FAST RECOVERY DIODE

### ■ Outline drawings, mm

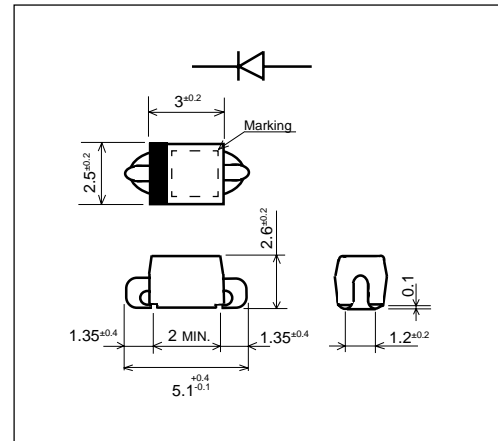

### ■ Features

- Surface mount device
- High voltage by mesa design
- High reliability

### ■ Applications

- High speed switching

### ■ Maximum ratings and characteristics

- Absolute maximum ratings

Item	Symbol	Conditions	Rating		Unit
			-04	-06	
Repetitive peak reverse voltage	$V_{RRM}$		400	600	V
Non-repetitive peak reverse voltage	$V_{RSM}$		400	600	V
Average output current	$I_o$	Resistive load ( $T_a=25^\circ\text{C}$ )	0.5*		A
Surge current	$I_{FSM}$	Sine wave 10ms	10		A
Operating junction temperature	$T_j$		-40 to +150		$^\circ\text{C}$
Storage temperature	$T_{stg}$		-40 to +150		$^\circ\text{C}$

\*Mounted to glass fabric base epoxy resin printed circuits, land (15mm x 15mm)

- Electrical characteristics ( $T_a=25^\circ\text{C}$  Unless otherwise specified)

Item	Symbol	Conditions	Max.	Unit
Forward voltage drop	$V_{FM}$	$I_{FM}=0.5\text{A}$	2.5	V
Reverse current	$I_{RRM}$	$V_R=V_{RRM}$	50	$\mu\text{A}$
Reverse recovery time	$t_{rr}$	$I_F=0.1\text{A}$ , $I_R=0.2\text{A}$ , $I_{rec}=0.05\text{A}$	50	ns
Thermal resistance	$R_{th(j-a)}$	Junction to ambient	120*	$^\circ\text{C/W}$

### ■ Marking

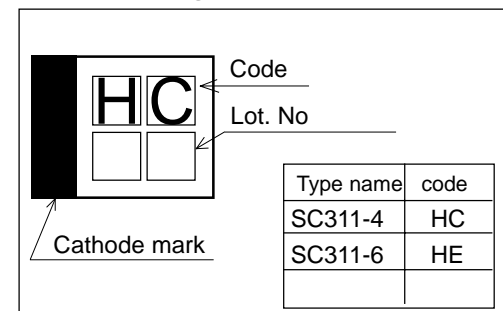

Characteristics

Forward characteristics

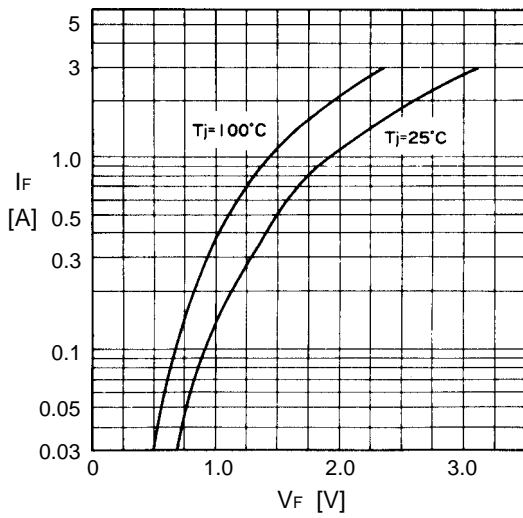

Reverse characteristics

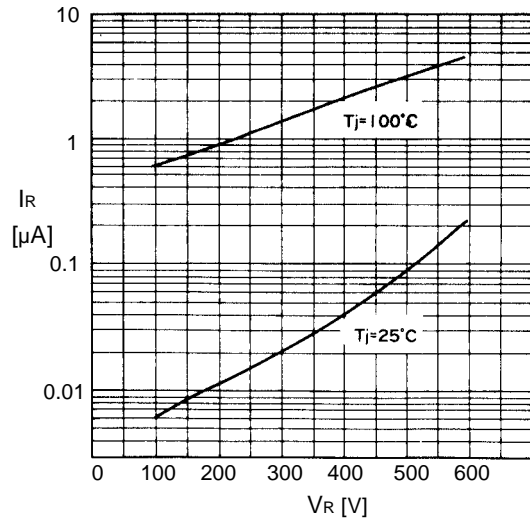

Current derating ( $I_o - T_a$ )

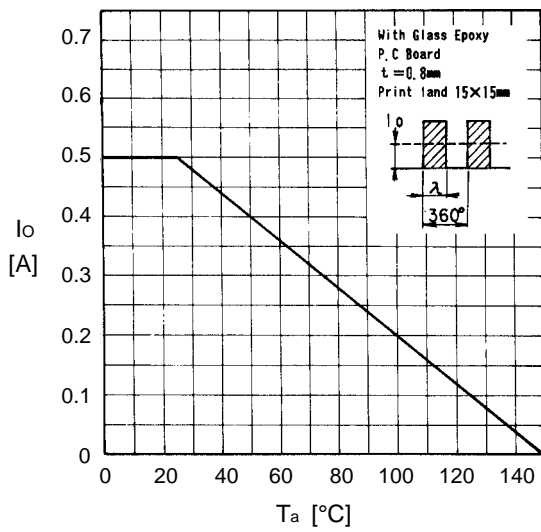

Junction capacitance characteristics

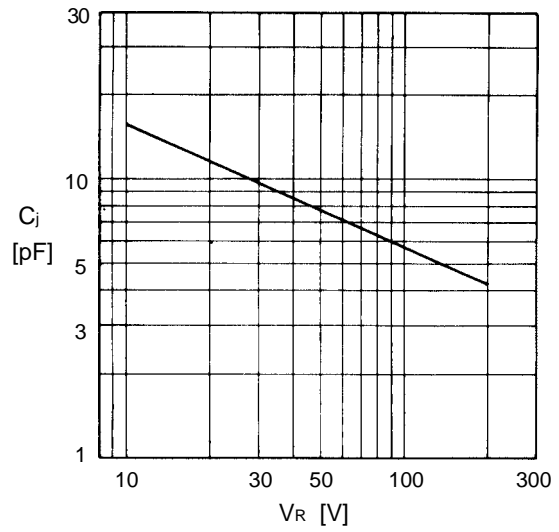

Surge capability

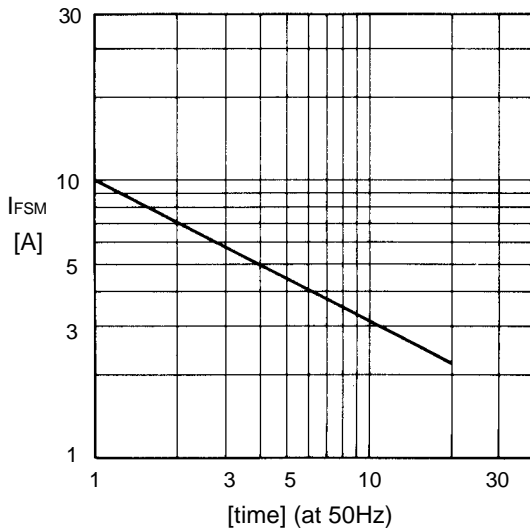

Thermal resistance print land

