



三洋半導体ニュース

No. N7493

62503

新

SBFP450M — NPN エピタキシャルプレーナ型シリコントランジスタ 高周波中出力増幅、RF ドライバ / パワーアンプ用

- 特長**
- ・低雑音である : $NF=1.25\text{dB typ}(f=1.8\text{GHz})$
 - ・しゃ断周波数が高い : $f_T=24\text{GHz typ}(V_{CE}=3\text{V} / f=1\text{GHz})$
: $f_T=17\text{GHz typ}(V_{CE}=3\text{V} / f=2\text{GHz})$
 - ・低電圧動作。
 - ・高利得である : $|S_{21e}|^2=11.5\text{dB typ}(f=1.8\text{GHz})$

絶対最大定格 Absolute Maximum Ratings / Ta=25

			unit
コレクタ・ベース電圧	V_{CBO}	15	V
コレクタ・エミッタ電圧	V_{CEO}	4.5	V
エミッタ・ベース電圧	V_{EBO}	1.5	V
コレクタ電流	I_C	100	mA
コレクタ損失	P_C	450	mW
接合部温度	T_j	150	
保存周囲温度	T_{stg}	- 55 ~ + 150	

電気的特性 Electrical Characteristics / Ta=25

			min	typ	max	unit
コレクタしゃ断電流	I_{CBO}	$V_{CB}=5\text{V}, I_E=0$			600	nA
エミッタしゃ断電流	I_{EBO}	$V_{EB}=1.5\text{V}, I_C=0$			100	μA
直流電流増幅率	h_{FE}	$V_{CE}=4\text{V}, I_C=20\text{mA}$	50		150	

次ページへ続く。

単体品名表示 : MD

電気的接続図 (Top view)

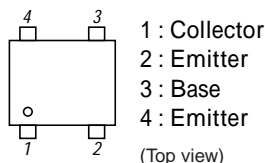

本製品は、高周波プロセスを採用しています。静電気等への影響を受けやすくなっていますので取扱いにご注意下さい。

外形図 2213

(unit : mm)

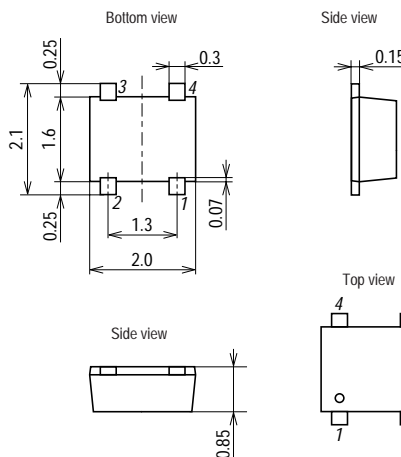

- 1 : Collector
- 2 : Emitter
- 3 : Base
- 4 : Emitter

SANYO : MCPH4

■本書記載の製品は、極めて高度の信頼性を要する用途(生命維持装置、航空機のコントロールシステム等、多大な人的・物的損害を及ぼす恐れのある用途)に対応する仕様にはなっておりません。そのような場合には、あらかじめ三洋電機販売窓口までご相談下さい。

■本書記載の規格値(最大定格、動作条件範囲等)を瞬時たりとも越えて使用し、その結果発生した機器の欠陥について、弊社は責任を負いません。

SBFP450M

前ページより続く。

			min	typ	max	unit
利得帯域幅積	$f_T(1)$	$V_{CE}=3V, I_C=90mA, f=1GHz$		24		GHz
	$f_T(2)$	$V_{CE}=3V, I_C=90mA, f=2GHz$	15	17		GHz
帰還容量	C_{re}	$V_{CB}=2V, f=1MHz$		0.48	0.8	pF
順方向伝達利得	$ S_{21e} ^2$	$V_{CE}=2V, I_C=50mA, f=1.8GHz$	8	11.5		dB
雑音指数	NF	$V_{CE}=2V, I_C=10mA, f=1.8GHz$		1.25		dB

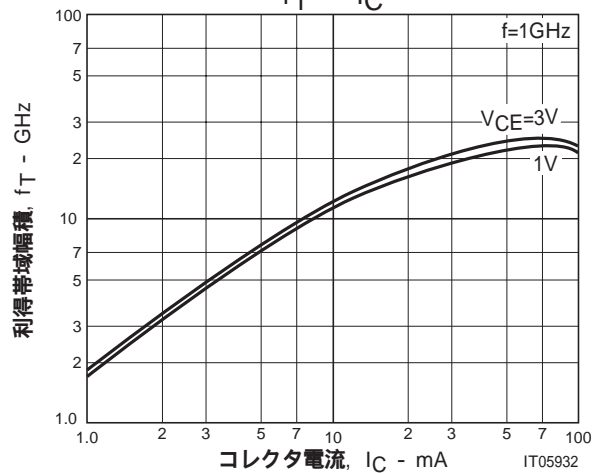
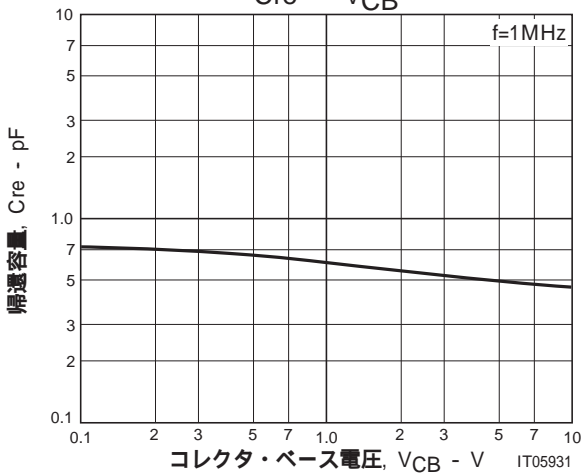
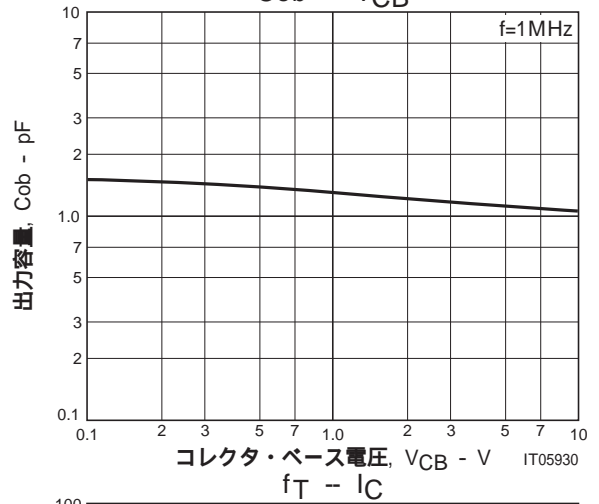
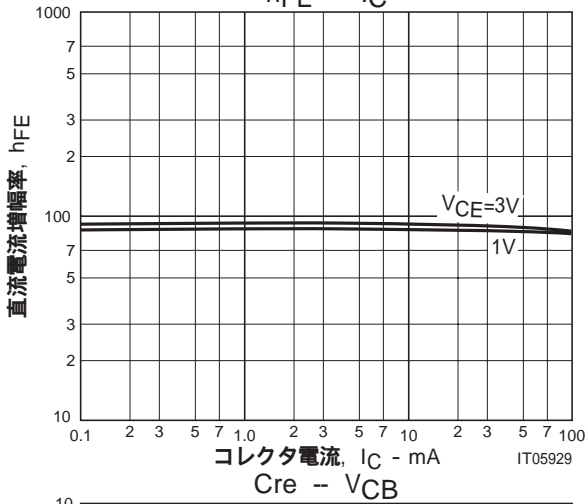
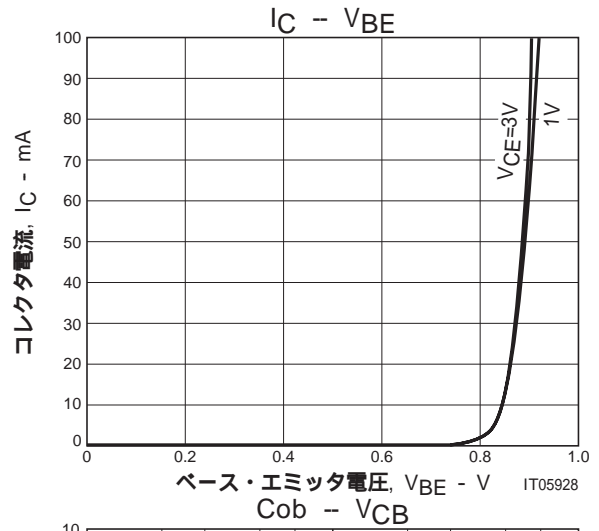
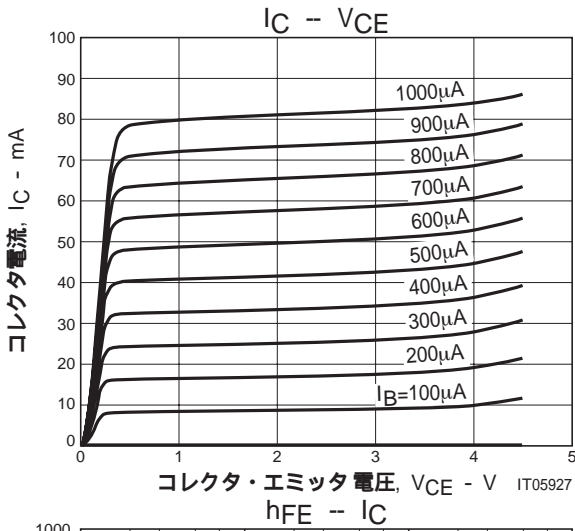

SBFP450M

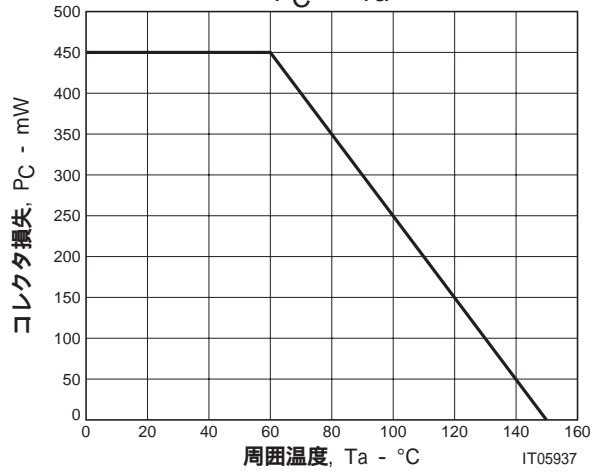
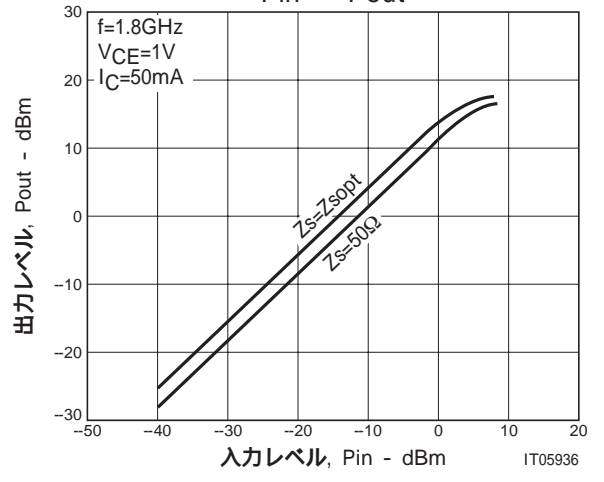
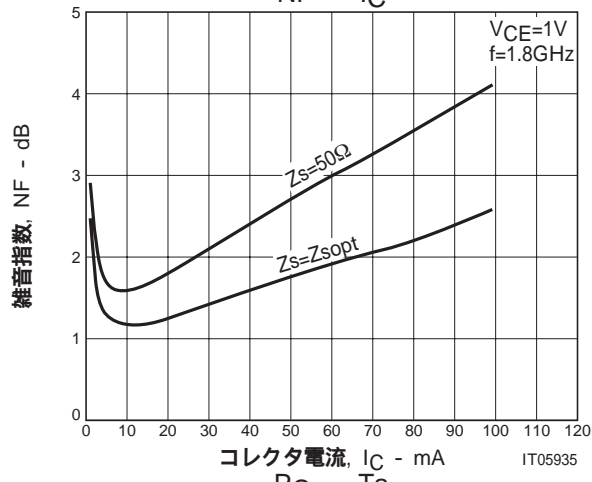
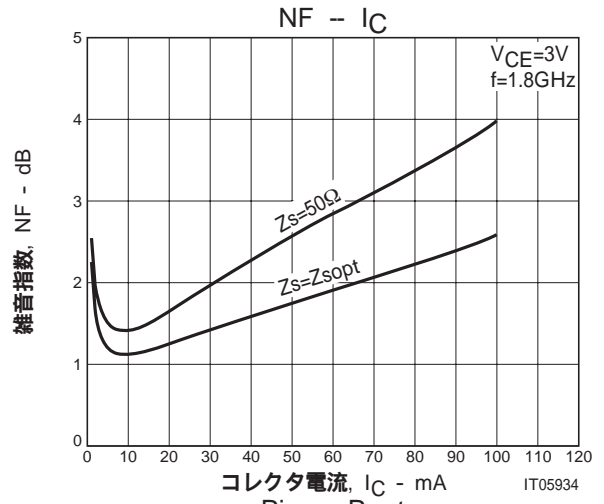
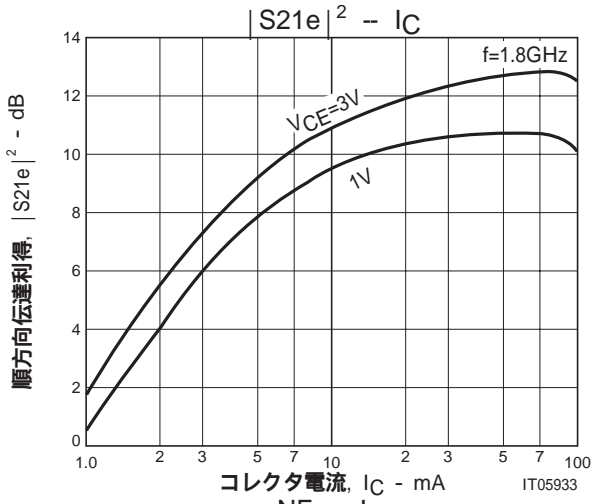

SBFP450M

S パラメータ (エミッタ接地)

$V_{CE}=1V, I_C=5mA, Z_O=50\Omega$

Freq(MHz)	$ S_{11} $	$\angle S_{11}$	$ S_{21} $	$\angle S_{21}$	$ S_{12} $	$\angle S_{12}$	$ S_{22} $	$\angle S_{22}$
200	0.769	-60.7	11.328	141.1	0.060	55.7	0.844	-47.7
400	0.738	-101.8	8.647	116.9	0.085	37.0	0.664	-77.9
600	0.734	-127.4	6.625	100.8	0.095	26.7	0.578	-98.2
800	0.707	-141.7	5.135	91.7	0.098	23.0	0.498	-108.0
1000	0.708	-150.8	4.176	84.3	0.101	20.1	0.459	-117.6
1200	0.699	-159.7	3.537	78.4	0.101	19.5	0.433	-124.7
1400	0.694	-166.3	3.029	73.3	0.102	19.3	0.411	-130.6
1600	0.695	-172.1	2.695	68.2	0.104	19.5	0.400	-136.0
1800	0.694	-177.9	2.415	63.8	0.105	19.7	0.390	-140.5
2000	0.695	177.1	2.149	58.9	0.107	19.9	0.380	-142.2
2200	0.700	172.5	2.012	55.0	0.110	20.4	0.377	-148.8
2400	0.702	167.5	1.855	50.6	0.112	20.6	0.374	-152.9
2600	0.705	162.8	1.723	45.9	0.114	21.0	0.368	-156.7
2800	0.706	158.4	1.589	41.9	0.117	20.9	0.371	-160.0
3000	0.710	153.8	1.508	38.3	0.120	22.0	0.378	-166.3
3200	0.714	149.6	1.422	34.4	0.123	22.3	0.383	-171.0
3400	0.720	145.5	1.339	30.6	0.127	22.3	0.391	-175.4
3600	0.727	141.8	1.265	26.8	0.130	22.1	0.398	-179.4
3800	0.732	138.3	1.197	23.2	0.134	22.3	0.411	176.4
4000	0.739	134.8	1.135	19.7	0.137	22.1	0.423	172.5
4200	0.748	131.7	1.081	16.5	0.142	22.0	0.436	168.8
4400	0.754	128.5	1.030	13.3	0.146	21.7	0.450	165.2
4600	0.763	125.7	0.984	10.2	0.151	21.3	0.463	162.1
4800	0.769	122.9	0.939	7.2	0.155	20.7	0.476	159.6
5000	0.774	120.3	0.900	4.5	0.160	20.2	0.489	157.0
5200	0.782	117.8	0.858	1.4	0.164	19.5	0.500	154.8
5400	0.784	115.2	0.833	-1.2	0.170	18.5	0.511	151.9
5600	0.788	112.8	0.783	-3.8	0.174	17.7	0.526	150.8
5800	0.789	110.4	0.774	-6.1	0.180	16.7	0.531	147.4
6000	0.784	105.3	0.742	-10.1	0.184	13.9	0.534	142.8

SBFP450M

S パラメータ (エミッタ接地)

$V_{CE}=1V, I_C=10mA, Z_0=50\Omega$

Freq(MHz)	$ S_{11} $	$\angle S_{11}$	$ S_{21} $	$\angle S_{21}$	$ S_{12} $	$\angle S_{12}$	$ S_{22} $	$\angle S_{22}$
200	0.670	-88.3	17.958	131.1	0.047	48.7	0.752	-67.8
400	0.683	-129.0	11.890	107.7	0.061	34.8	0.581	-102.2
600	0.701	-148.4	8.446	94.2	0.066	29.8	0.529	-121.9
800	0.688	-158.8	6.401	87.2	0.070	30.3	0.470	-132.0
1000	0.689	-165.6	5.138	81.3	0.074	30.5	0.448	-140.8
1200	0.685	-172.3	4.318	76.5	0.078	32.7	0.432	-146.9
1400	0.683	-177.8	3.702	72.1	0.083	34.2	0.418	-152.7
1600	0.683	177.6	3.269	67.9	0.088	35.1	0.412	-157.6
1800	0.682	172.7	2.925	63.9	0.094	36.0	0.403	-161.5
2000	0.682	168.2	2.634	59.8	0.099	36.1	0.393	-164.1
2200	0.685	164.3	2.432	56.1	0.106	36.4	0.393	-169.5
2400	0.686	159.9	2.244	52.0	0.112	36.2	0.391	-173.3
2600	0.690	155.7	2.082	48.0	0.118	35.9	0.388	-177.0
2800	0.690	151.8	1.933	44.3	0.124	35.0	0.389	179.7
3000	0.694	147.8	1.816	40.7	0.130	34.4	0.398	174.9
3200	0.698	144.0	1.708	37.1	0.136	33.5	0.405	170.6
3400	0.704	140.3	1.612	33.6	0.142	32.5	0.413	166.9
3600	0.711	136.9	1.522	30.0	0.147	31.2	0.420	163.3
3800	0.716	133.7	1.441	26.7	0.152	30.1	0.431	159.8
4000	0.722	130.7	1.366	23.4	0.157	28.7	0.444	156.7
4200	0.730	127.8	1.300	20.3	0.163	27.7	0.454	153.5
4400	0.737	125.0	1.239	17.3	0.168	26.5	0.466	150.9
4600	0.745	122.3	1.183	14.3	0.172	25.1	0.478	148.1
4800	0.751	119.8	1.131	11.5	0.177	23.7	0.487	146.1
5000	0.757	117.3	1.088	8.7	0.182	22.4	0.497	144.0
5200	0.763	114.9	1.044	5.9	0.187	21.0	0.504	142.1
5400	0.766	112.6	0.994	2.8	0.191	19.7	0.514	139.8
5600	0.768	110.3	0.968	0.7	0.197	18.2	0.521	138.6
5800	0.769	108.0	0.943	-1.9	0.202	16.6	0.526	136.0
6000	0.765	103.2	0.904	-5.8	0.204	13.6	0.529	131.6

SBFP450M

S パラメータ (エミッタ接地)

$V_{CE}=1V, I_C=20mA, Z_O=50\Omega$

Freq(MHz)	$ S_{11} $	$\angle S_{11}$	$ S_{21} $	$\angle S_{21}$	$ S_{12} $	$\angle S_{12}$	$ S_{22} $	$\angle S_{22}$
200	0.623	-122.1	24.243	120.4	0.034	45.0	0.670	-89.8
400	0.673	-151.0	14.107	100.6	0.043	38.9	0.547	-124.4
600	0.697	-163.5	9.635	89.7	0.048	38.9	0.525	-140.5
800	0.691	-171.0	7.231	84.2	0.054	42.6	0.486	-149.8
1000	0.691	-176.0	5.782	79.3	0.060	44.6	0.476	-157.1
1200	0.688	178.8	4.846	75.2	0.068	47.1	0.465	-162.0
1400	0.685	174.2	4.150	71.3	0.075	48.6	0.457	-167.1
1600	0.684	170.3	3.652	67.4	0.083	49.2	0.451	-170.8
1800	0.682	166.0	3.274	64.1	0.092	48.7	0.447	-174.6
2000	0.682	162.0	2.967	60.4	0.100	48.1	0.436	-177.7
2200	0.684	158.5	2.712	56.7	0.108	47.6	0.435	177.8
2400	0.684	154.6	2.502	53.0	0.117	46.3	0.432	174.5
2600	0.686	150.7	2.326	49.3	0.125	44.6	0.432	171.0
2800	0.686	147.2	2.163	45.8	0.133	43.4	0.434	167.4
3000	0.690	143.4	2.022	42.4	0.140	41.7	0.442	163.5
3200	0.694	140.0	1.904	38.9	0.148	40.0	0.449	159.8
3400	0.699	136.6	1.794	35.7	0.155	38.2	0.461	156.6
3600	0.706	133.4	1.691	32.2	0.161	36.3	0.462	153.1
3800	0.710	130.4	1.605	29.2	0.166	34.3	0.473	150.1
4000	0.717	127.7	1.519	26.0	0.172	32.7	0.484	147.2
4200	0.724	124.9	1.445	23.1	0.177	30.9	0.496	143.8
4400	0.730	122.3	1.380	20.1	0.183	29.2	0.506	141.7
4600	0.739	119.8	1.316	17.4	0.188	27.4	0.515	139.5
4800	0.743	117.4	1.263	14.7	0.192	25.7	0.522	137.3
5000	0.749	115.1	1.212	12.1	0.197	24.0	0.532	135.5
5200	0.755	112.7	1.168	9.5	0.202	22.5	0.537	133.4
5400	0.757	110.6	1.129	6.8	0.207	20.5	0.545	131.8
5600	0.758	108.3	1.088	4.2	0.212	18.8	0.548	129.9
5800	0.760	106.1	1.058	2.0	0.217	16.9	0.550	128.0
6000	0.756	101.4	1.015	-2.2	0.219	13.8	0.554	123.6

SBFP450M

S パラメータ (エミッタ接地)

$V_{CE}=1V, I_C=40mA, Z_0=50\Omega$

Freq(MHz)	$ S_{11} $	$\angle S_{11}$	$ S_{21} $	$\angle S_{21}$	$ S_{12} $	$\angle S_{12}$	$ S_{22} $	$\angle S_{22}$
200	0.641	-146.5	27.826	112.8	0.024	46.2	0.624	-109.5
400	0.692	-164.9	15.249	96.1	0.031	46.8	0.551	-140.5
600	0.710	-172.7	10.202	87.0	0.038	49.9	0.549	-153.1
800	0.707	-178.3	7.659	82.3	0.046	54.9	0.520	-161.1
1000	0.705	177.8	6.130	77.9	0.055	56.3	0.514	-167.2
1200	0.701	173.4	5.110	74.1	0.064	57.8	0.505	-171.3
1400	0.700	169.5	4.396	70.7	0.073	58.1	0.499	-176.0
1600	0.697	166.1	3.870	67.2	0.082	57.3	0.494	-179.6
1800	0.694	162.2	3.461	64.1	0.092	56.3	0.488	177.0
2000	0.692	158.5	3.144	60.3	0.102	54.8	0.481	173.9
2200	0.694	155.3	2.884	56.6	0.111	53.4	0.479	169.7
2400	0.694	151.7	2.643	53.3	0.120	51.5	0.480	166.4
2600	0.696	148.1	2.455	49.7	0.129	49.4	0.477	162.7
2800	0.694	144.7	2.288	46.4	0.137	47.1	0.481	159.4
3000	0.698	141.2	2.137	42.9	0.145	44.9	0.487	155.8
3200	0.701	137.9	2.009	39.6	0.152	42.9	0.497	152.1
3400	0.707	134.8	1.889	36.4	0.159	40.7	0.505	149.0
3600	0.712	131.7	1.782	33.1	0.166	38.3	0.512	145.7
3800	0.715	128.8	1.685	30.1	0.173	36.3	0.523	143.0
4000	0.721	126.1	1.601	27.1	0.178	34.1	0.534	140.0
4200	0.729	123.5	1.519	24.2	0.182	32.1	0.544	137.7
4400	0.733	121.1	1.447	21.4	0.188	29.9	0.551	135.1
4600	0.742	118.6	1.384	18.7	0.193	27.9	0.560	132.7
4800	0.747	116.2	1.327	16.0	0.198	26.1	0.565	130.9
5000	0.752	114.1	1.276	13.5	0.202	24.1	0.570	129.1
5200	0.757	111.8	1.231	10.8	0.207	22.1	0.574	127.0
5400	0.759	109.6	1.186	8.3	0.211	20.2	0.579	124.9
5600	0.759	107.4	1.149	5.8	0.216	18.2	0.582	123.2
5800	0.761	105.3	1.115	3.3	0.220	16.4	0.586	121.1
6000	0.757	100.5	1.067	-0.4	0.222	12.9	0.591	117.3

SBFP450M

S パラメータ (エミッタ接地)

$V_{CE}=1V, I_C=70mA, Z_0=50\Omega$

Freq(MHz)	$ S_{11} $	$\angle S_{11}$	$ S_{21} $	$\angle S_{21}$	$ S_{12} $	$\angle S_{12}$	$ S_{22} $	$\angle S_{22}$
200	0.671	-159.0	28.263	108.9	0.019	50.1	0.604	-121.0
400	0.709	-171.5	15.245	94.1	0.027	54.8	0.560	-148.5
600	0.722	-177.3	10.169	85.6	0.035	58.6	0.564	-158.8
800	0.719	178.1	7.628	81.4	0.044	62.1	0.540	-166.2
1000	0.716	174.7	6.098	77.3	0.054	63.3	0.536	-171.5
1200	0.714	170.7	5.109	73.9	0.064	63.8	0.527	-175.4
1400	0.712	167.1	4.376	70.7	0.074	63.1	0.524	-179.5
1600	0.708	163.9	3.860	67.2	0.083	61.4	0.520	176.9
1800	0.704	160.1	3.456	63.8	0.093	60.1	0.512	173.8
2000	0.703	156.7	3.152	60.6	0.104	58.2	0.504	170.8
2200	0.704	153.6	2.855	56.8	0.113	56.3	0.504	166.7
2400	0.703	150.0	2.643	53.4	0.123	53.9	0.503	163.4
2600	0.704	146.4	2.454	49.9	0.131	51.7	0.501	160.1
2800	0.702	143.2	2.289	46.6	0.140	49.1	0.508	156.6
3000	0.706	139.7	2.134	43.2	0.148	46.8	0.512	153.2
3200	0.709	136.6	2.005	39.9	0.157	44.4	0.519	149.7
3400	0.714	133.5	1.887	36.8	0.164	41.9	0.530	146.5
3600	0.720	130.5	1.782	33.5	0.170	39.5	0.535	143.5
3800	0.723	127.7	1.685	30.5	0.176	37.3	0.546	140.5
4000	0.728	125.1	1.596	27.6	0.182	35.1	0.554	138.1
4200	0.735	122.5	1.519	24.8	0.188	32.8	0.567	135.4
4400	0.740	120.1	1.447	22.0	0.192	30.6	0.575	133.0
4600	0.748	117.6	1.383	19.3	0.197	28.7	0.581	130.9
4800	0.753	115.3	1.327	16.7	0.202	26.6	0.584	129.0
5000	0.757	113.2	1.277	14.3	0.207	24.6	0.590	126.9
5200	0.761	110.9	1.231	11.6	0.212	22.5	0.595	124.9
5400	0.764	108.8	1.187	9.1	0.216	20.6	0.600	123.0
5600	0.764	106.6	1.152	6.8	0.220	18.6	0.601	121.3
5800	0.765	104.4	1.116	4.2	0.225	16.6	0.605	119.2
6000	0.761	99.8	1.068	0.4	0.227	13.1	0.608	115.3

SBFP450M

S パラメータ (エミッタ接地)

$V_{CE}=2V, I_C=5mA, Z_O=50\Omega$

Freq(MHz)	$ S_{11} $	$\angle S_{11}$	$ S_{21} $	$\angle S_{21}$	$ S_{12} $	$\angle S_{12}$	$ S_{22} $	$\angle S_{22}$
200	0.770	-58.9	12.902	143.2	0.052	58.2	0.866	-41.9
400	0.742	-98.7	9.811	119.1	0.075	39.8	0.689	-69.7
600	0.736	-123.9	7.502	102.9	0.085	29.2	0.594	-89.2
800	0.706	-138.4	5.807	93.5	0.089	24.9	0.508	-98.3
1000	0.707	-147.8	4.720	85.7	0.092	21.6	0.462	-107.8
1200	0.695	-156.9	3.992	79.5	0.092	21.4	0.432	-115.0
1400	0.689	-163.8	3.420	74.5	0.093	21.0	0.406	-120.9
1600	0.690	-169.6	3.031	69.4	0.094	21.3	0.391	-126.5
1800	0.688	-175.4	2.709	64.8	0.095	21.8	0.379	-131.0
2000	0.689	179.4	2.408	60.0	0.098	21.7	0.369	-132.8
2200	0.694	174.7	2.251	55.9	0.100	22.6	0.361	-139.8
2400	0.695	169.8	2.074	51.5	0.102	23.0	0.356	-144.3
2600	0.699	164.9	1.922	46.9	0.104	23.2	0.349	-148.5
2800	0.699	160.5	1.765	42.9	0.108	23.5	0.351	-151.9
3000	0.704	155.9	1.681	39.2	0.111	24.6	0.355	-158.6
3200	0.707	151.6	1.582	35.4	0.115	24.7	0.358	-163.7
3400	0.714	147.5	1.488	31.5	0.117	25.0	0.366	-168.6
3600	0.721	143.7	1.405	27.6	0.120	25.1	0.372	-173.2
3800	0.725	140.0	1.327	24.0	0.125	24.8	0.385	-177.4
4000	0.732	136.6	1.257	20.5	0.129	24.8	0.397	178.4
4200	0.740	133.5	1.197	17.2	0.134	24.8	0.409	174.4
4400	0.746	130.2	1.142	14.0	0.138	24.4	0.422	170.6
4600	0.755	127.3	1.089	10.8	0.142	24.0	0.435	167.1
4800	0.762	124.6	1.037	7.7	0.147	23.2	0.448	164.2
5000	0.768	121.9	0.993	4.8	0.152	22.8	0.461	161.3
5200	0.775	119.4	0.946	1.7	0.157	22.1	0.472	158.9
5400	0.778	116.8	0.919	-1.0	0.162	21.0	0.484	155.5
5600	0.782	114.3	0.859	-3.9	0.167	20.0	0.500	154.4
5800	0.784	111.9	0.850	-6.2	0.173	18.7	0.506	150.6
6000	0.779	106.9	0.814	-10.4	0.177	16.1	0.510	145.8

SBFP450M

S パラメータ (エミッタ接地)

$V_{CE}=2V$, $I_C=10mA$, $Z_O=50\Omega$

Freq(MHz)	$ S_{11} $	$\angle S_{11}$	$ S_{21} $	$\angle S_{21}$	$ S_{12} $	$\angle S_{12}$	$ S_{22} $	$\angle S_{22}$
200	0.664	-84.3	20.284	133.6	0.041	52.0	0.774	-59.6
400	0.675	-124.6	13.498	110.0	0.054	37.6	0.586	-92.2
600	0.691	-144.6	9.641	96.0	0.060	31.8	0.520	-112.1
800	0.677	-155.8	7.314	88.6	0.064	32.0	0.450	-121.9
1000	0.677	-162.8	5.875	82.3	0.068	32.3	0.423	-131.3
1200	0.672	-169.8	4.922	77.3	0.072	34.3	0.404	-137.9
1400	0.669	-175.4	4.203	72.8	0.076	35.8	0.387	-143.9
1600	0.669	179.8	3.718	68.4	0.081	36.8	0.378	-148.9
1800	0.667	174.9	3.316	64.4	0.086	37.7	0.369	-153.4
2000	0.668	170.5	2.982	60.1	0.092	37.8	0.358	-156.1
2200	0.671	166.5	2.747	56.6	0.098	38.3	0.356	-161.9
2400	0.673	162.1	2.527	52.5	0.103	38.0	0.353	-166.0
2600	0.676	157.7	2.342	48.4	0.109	37.9	0.349	-170.3
2800	0.677	154.0	2.168	44.8	0.115	36.9	0.351	-173.9
3000	0.680	149.8	2.041	41.2	0.122	36.5	0.359	-179.1
3200	0.685	146.0	1.919	37.5	0.127	35.4	0.364	176.2
3400	0.692	142.4	1.804	34.0	0.133	34.4	0.372	172.0
3600	0.698	138.8	1.702	30.4	0.138	33.5	0.379	168.1
3800	0.703	135.6	1.609	27.1	0.144	32.0	0.392	164.5
4000	0.710	132.6	1.526	23.9	0.149	30.9	0.404	161.0
4200	0.718	129.6	1.451	20.7	0.154	29.6	0.416	157.8
4400	0.725	126.8	1.383	17.6	0.158	28.6	0.427	154.8
4600	0.733	124.0	1.320	14.6	0.163	27.1	0.438	152.0
4800	0.740	121.5	1.262	11.7	0.168	25.8	0.449	149.8
5000	0.745	119.1	1.210	8.9	0.173	24.2	0.460	147.4
5200	0.752	116.6	1.160	5.9	0.177	23.0	0.466	145.2
5400	0.755	114.3	1.121	3.2	0.182	21.4	0.476	142.7
5600	0.758	111.9	1.070	0.5	0.186	20.0	0.485	141.5
5800	0.761	109.7	1.045	-2.1	0.192	18.4	0.492	138.7
6000	0.757	104.7	1.002	-6.1	0.195	15.4	0.497	134.1

SBFP450M

S パラメータ (エミッタ接地)

$V_{CE}=2V, I_C=20mA, Z_O=50\Omega$

Freq(MHz)	$ S_{11} $	$\angle S_{11}$	$ S_{21} $	$\angle S_{21}$	$ S_{12} $	$\angle S_{12}$	$ S_{22} $	$\angle S_{22}$
200	0.597	-115.2	27.281	123.7	0.031	48.0	0.682	-79.5
400	0.651	-146.8	16.207	102.8	0.038	40.2	0.528	-113.7
600	0.676	-160.3	11.100	91.2	0.044	40.9	0.494	-131.4
800	0.670	-168.4	8.361	85.2	0.050	44.3	0.445	-141.2
1000	0.671	-173.7	6.684	79.9	0.056	45.9	0.431	-149.2
1200	0.667	-179.1	5.573	75.6	0.062	48.6	0.419	-154.8
1400	0.665	176.2	4.777	71.6	0.070	49.9	0.408	-160.3
1600	0.663	172.3	4.198	67.9	0.078	50.2	0.403	-164.5
1800	0.662	168.0	3.732	64.3	0.085	50.4	0.395	-168.6
2000	0.661	164.0	3.372	60.5	0.093	50.0	0.386	-171.8
2200	0.663	160.5	3.095	57.1	0.101	49.0	0.384	-176.5
2400	0.664	156.6	2.848	53.2	0.109	47.9	0.382	179.5
2600	0.666	152.7	2.638	49.5	0.117	46.5	0.381	175.6
2800	0.667	149.2	2.452	46.1	0.124	45.2	0.384	172.0
3000	0.671	145.4	2.296	42.6	0.131	43.2	0.391	167.8
3200	0.675	141.9	2.157	39.2	0.139	41.7	0.398	163.5
3400	0.680	138.5	2.027	35.8	0.145	39.7	0.408	159.9
3600	0.688	135.4	1.913	32.5	0.150	37.9	0.414	156.3
3800	0.692	132.4	1.808	29.4	0.156	36.1	0.427	153.2
4000	0.699	129.5	1.715	26.3	0.162	34.5	0.437	150.2
4200	0.707	126.8	1.632	23.3	0.168	32.6	0.450	147.0
4400	0.714	124.1	1.554	20.3	0.172	30.8	0.460	144.6
4600	0.723	121.5	1.483	17.5	0.177	29.1	0.469	142.0
4800	0.729	119.1	1.420	14.7	0.183	27.2	0.477	140.0
5000	0.733	116.9	1.362	12.0	0.187	25.6	0.486	138.0
5200	0.741	114.5	1.310	9.2	0.192	23.8	0.492	135.8
5400	0.743	112.3	1.263	6.6	0.196	22.2	0.501	133.9
5600	0.745	110.0	1.218	4.0	0.201	20.5	0.505	132.2
5800	0.747	107.8	1.181	1.4	0.206	18.5	0.510	129.8
6000	0.744	103.1	1.133	-2.5	0.208	15.1	0.516	125.8

SBFP450M

S パラメータ (エミッタ接地)

$V_{CE}=2V$, $I_C=40mA$, $Z_O=50\Omega$

Freq(MHz)	$ S_{11} $	$\angle S_{11}$	$ S_{21} $	$\angle S_{21}$	$ S_{12} $	$\angle S_{12}$	$ S_{22} $	$\angle S_{22}$
200	0.594	-146.6	32.741	114.8	0.020	50.8	0.603	-100.3
400	0.654	-164.5	18.011	97.3	0.027	52.0	0.505	-132.5
600	0.675	-172.3	12.077	87.7	0.035	55.0	0.496	-146.4
800	0.672	-177.9	9.051	82.3	0.043	59.0	0.463	-154.9
1000	0.672	178.3	7.201	78.2	0.051	61.1	0.455	-161.4
1200	0.670	174.0	6.020	74.5	0.060	61.6	0.446	-165.9
1400	0.667	170.0	5.148	70.9	0.070	61.8	0.441	-171.1
1600	0.663	166.6	4.532	67.2	0.078	61.1	0.434	-174.8
1800	0.661	162.8	4.032	64.2	0.088	59.7	0.427	-178.1
2000	0.660	159.2	3.648	60.7	0.098	58.1	0.419	178.6
2200	0.661	155.9	3.356	56.6	0.106	56.6	0.418	174.3
2400	0.662	152.3	3.072	53.8	0.115	54.3	0.420	170.9
2600	0.663	148.8	2.846	50.3	0.124	52.2	0.419	167.1
2800	0.661	145.5	2.648	47.1	0.132	50.2	0.420	163.8
3000	0.666	142.0	2.473	43.6	0.140	48.0	0.428	160.0
3200	0.669	138.8	2.322	40.4	0.148	46.0	0.434	156.1
3400	0.676	135.7	2.182	37.3	0.154	43.3	0.444	152.7
3600	0.683	132.6	2.059	34.1	0.161	41.2	0.451	149.5
3800	0.688	129.7	1.948	31.1	0.167	39.2	0.465	146.5
4000	0.694	127.0	1.847	28.1	0.173	36.7	0.475	143.7
4200	0.702	124.5	1.754	25.3	0.179	34.6	0.485	141.1
4400	0.708	122.0	1.671	22.4	0.183	33.0	0.493	138.6
4600	0.716	119.6	1.595	19.7	0.189	30.9	0.503	136.3
4800	0.723	117.1	1.528	17.0	0.194	28.6	0.511	134.2
5000	0.728	115.0	1.471	14.5	0.199	27.0	0.517	132.2
5200	0.734	112.7	1.414	11.8	0.202	25.1	0.522	130.3
5400	0.737	110.6	1.363	9.3	0.207	22.9	0.527	128.3
5600	0.738	108.4	1.320	6.8	0.213	21.2	0.532	126.5
5800	0.740	106.2	1.279	4.3	0.217	19.2	0.536	124.5
6000	0.738	101.5	1.225	0.5	0.219	15.7	0.542	120.5

SBFP450M

S パラメータ (エミッタ接地)

$V_{CE}=2V, I_C=70mA, Z_O=50\Omega$

Freq(MHz)	$ S_{11} $	$\angle S_{11}$	$ S_{21} $	$\angle S_{21}$	$ S_{12} $	$\angle S_{12}$	$ S_{22} $	$\angle S_{22}$
200	0.605	-153.9	33.676	112.9	0.018	54.7	0.585	-105.3
400	0.659	-168.5	18.263	96.2	0.025	57.3	0.501	-136.4
600	0.679	-174.8	12.214	87.0	0.033	60.1	0.496	-149.1
800	0.677	-179.9	9.173	82.3	0.042	63.5	0.465	-157.6
1000	0.676	176.5	7.295	77.8	0.051	64.8	0.460	-163.7
1200	0.672	172.6	6.088	74.4	0.061	64.8	0.453	-168.2
1400	0.670	168.7	5.183	70.8	0.069	64.2	0.446	-172.8
1600	0.667	165.4	4.575	67.4	0.079	62.9	0.441	-176.4
1800	0.664	161.7	4.095	64.0	0.089	62.0	0.433	-179.9
2000	0.661	158.1	3.704	60.7	0.098	59.8	0.428	176.7
2200	0.663	155.1	3.364	57.2	0.108	58.0	0.425	172.9
2400	0.663	151.5	3.103	53.9	0.116	56.0	0.424	169.4
2600	0.665	147.9	2.879	50.4	0.124	53.2	0.424	165.8
2800	0.665	144.7	2.677	47.2	0.133	51.2	0.429	162.3
3000	0.668	141.2	2.500	43.9	0.141	48.8	0.434	158.5
3200	0.672	138.1	2.346	40.6	0.149	46.9	0.443	155.0
3400	0.677	134.9	2.208	37.5	0.156	44.2	0.453	151.6
3600	0.684	132.0	2.080	34.4	0.163	42.0	0.458	148.4
3800	0.688	129.2	1.970	31.4	0.168	39.8	0.471	145.4
4000	0.695	126.5	1.866	28.5	0.175	37.5	0.481	142.7
4200	0.702	124.0	1.773	25.6	0.181	35.5	0.492	140.1
4400	0.709	121.6	1.687	22.7	0.185	33.5	0.500	137.7
4600	0.717	119.1	1.614	20.0	0.191	31.3	0.510	135.4
4800	0.724	116.8	1.546	17.4	0.196	29.2	0.517	133.2
5000	0.729	114.6	1.484	14.9	0.199	27.2	0.523	131.2
5200	0.734	112.3	1.429	12.3	0.206	25.5	0.527	129.3
5400	0.738	110.3	1.380	9.8	0.210	23.2	0.534	127.3
5600	0.739	108.1	1.336	7.3	0.215	21.2	0.539	125.5
5800	0.741	105.9	1.292	4.7	0.219	19.3	0.542	123.5
6000	0.738	101.2	1.238	1.0	0.221	15.9	0.547	119.5

SBFP450M

S パラメータ (エミッタ接地)

$V_{CE}=3V, I_C=5mA, Z_O=50\Omega$

Freq(MHz)	$ S_{11} $	$\angle S_{11}$	$ S_{21} $	$\angle S_{21}$	$ S_{12} $	$\angle S_{12}$	$ S_{22} $	$\angle S_{22}$
200	0.770	-57.2	13.343	144.2	0.047	59.1	0.871	-39.5
400	0.742	-96.8	10.285	120.2	0.071	40.7	0.696	-65.9
600	0.734	-122.3	7.926	103.9	0.080	30.6	0.598	-84.7
800	0.703	-137.0	6.157	94.3	0.084	26.3	0.512	-93.3
1000	0.703	-146.6	5.009	86.4	0.086	23.2	0.463	-102.5
1200	0.690	-155.8	4.244	80.3	0.088	23.2	0.431	-109.4
1400	0.684	-162.8	3.625	74.9	0.088	22.8	0.404	-115.4
1600	0.684	-168.8	3.220	69.8	0.090	22.9	0.388	-120.9
1800	0.682	-174.6	2.866	65.1	0.091	23.8	0.374	-125.5
2000	0.683	-179.8	2.547	60.4	0.093	24.2	0.365	-127.0
2200	0.687	175.4	2.375	56.5	0.096	24.7	0.355	-134.0
2400	0.689	170.4	2.192	52.0	0.099	25.6	0.350	-138.5
2600	0.692	165.5	2.031	47.4	0.101	26.1	0.341	-142.8
2800	0.693	161.1	1.865	43.5	0.104	26.2	0.343	-146.1
3000	0.697	156.3	1.774	39.8	0.108	27.3	0.344	-153.1
3200	0.700	152.1	1.669	35.9	0.112	27.7	0.346	-158.3
3400	0.707	148.0	1.570	32.1	0.115	27.9	0.353	-163.4
3600	0.714	144.2	1.482	28.3	0.119	27.9	0.358	-168.1
3800	0.719	140.5	1.400	24.7	0.123	27.9	0.370	-172.7
4000	0.726	137.1	1.326	21.1	0.127	27.7	0.381	-177.0
4200	0.734	133.8	1.262	17.9	0.132	27.7	0.393	178.7
4400	0.740	130.6	1.203	14.6	0.137	27.4	0.406	174.7
4600	0.749	127.7	1.147	11.4	0.141	26.7	0.419	171.1
4800	0.756	124.9	1.093	8.3	0.147	26.0	0.432	168.1
5000	0.762	122.3	1.047	5.4	0.152	25.2	0.445	165.0
5200	0.770	119.7	0.997	2.3	0.156	24.4	0.457	162.4
5400	0.773	117.1	0.967	-0.4	0.163	23.5	0.469	159.1
5600	0.777	114.7	0.905	-3.3	0.167	22.5	0.485	157.8
5800	0.779	112.2	0.894	-5.8	0.173	21.3	0.491	154.0
6000	0.774	107.1	0.856	-9.9	0.178	18.3	0.494	149.0

SBFP450M

S パラメータ (エミッタ接地)

$V_{CE}=3V, I_C=10mA, Z_O=50\Omega$

Freq(MHz)	$ S_{11} $	$\angle S_{11}$	$ S_{21} $	$\angle S_{21}$	$ S_{12} $	$\angle S_{12}$	$ S_{22} $	$\angle S_{22}$
200	0.658	-81.6	21.004	134.9	0.039	53.2	0.778	-55.8
400	0.667	-122.3	14.207	111.2	0.052	38.5	0.586	-87.1
600	0.683	-142.9	10.207	97.0	0.058	33.3	0.511	-106.6
800	0.667	-154.3	7.763	89.3	0.061	33.8	0.440	-116.0
1000	0.668	-161.7	6.239	82.8	0.065	33.3	0.410	-125.3
1200	0.662	-168.7	5.231	77.7	0.068	35.6	0.388	-131.9
1400	0.659	-174.5	4.460	73.0	0.073	37.3	0.371	-138.1
1600	0.659	-179.3	3.939	68.7	0.078	38.8	0.360	-143.2
1800	0.657	175.7	3.511	64.8	0.083	39.2	0.350	-147.6
2000	0.658	171.3	3.153	60.7	0.089	39.5	0.340	-150.1
2200	0.661	167.3	2.903	56.9	0.095	40.2	0.336	-156.2
2400	0.663	162.8	2.669	52.8	0.101	40.1	0.333	-160.6
2600	0.666	158.5	2.474	48.8	0.108	39.9	0.327	-164.8
2800	0.667	154.6	2.286	45.2	0.113	38.9	0.330	-168.6
3000	0.670	150.4	2.153	41.6	0.119	38.7	0.336	-174.0
3200	0.676	146.6	2.022	38.0	0.124	37.5	0.340	-178.9
3400	0.682	142.9	1.902	34.5	0.130	36.6	0.348	176.7
3600	0.688	139.5	1.795	30.9	0.136	35.4	0.356	172.6
3800	0.694	136.2	1.698	27.6	0.142	34.0	0.368	168.7
4000	0.701	133.1	1.608	24.3	0.146	33.0	0.379	165.1
4200	0.709	130.1	1.531	21.2	0.151	31.8	0.392	161.7
4400	0.716	127.3	1.459	18.0	0.156	30.2	0.402	158.5
4600	0.725	124.6	1.392	15.0	0.162	29.0	0.415	155.5
4800	0.732	122.0	1.329	12.1	0.166	27.6	0.425	153.3
5000	0.739	119.5	1.275	9.3	0.171	26.2	0.436	150.8
5200	0.746	117.2	1.222	6.2	0.176	24.8	0.444	148.5
5400	0.749	114.8	1.180	3.5	0.181	23.3	0.455	146.0
5600	0.752	112.4	1.126	0.8	0.186	21.9	0.464	144.8
5800	0.754	110.0	1.098	-1.8	0.191	20.2	0.471	141.9
6000	0.751	105.2	1.053	-5.8	0.194	17.3	0.477	137.3

SBFP450M

S パラメータ (エミッタ接地)

$V_{CE}=3V, I_C=20mA, Z_O=50\Omega$

Freq(MHz)	$ S_{11} $	$\angle S_{11}$	$ S_{21} $	$\angle S_{21}$	$ S_{12} $	$\angle S_{12}$	$ S_{22} $	$\angle S_{22}$
200	0.579	-112.2	28.374	125.3	0.029	49.9	0.679	-74.2
400	0.635	-144.8	17.104	103.9	0.037	41.5	0.514	-107.8
600	0.662	-158.8	11.791	92.1	0.042	41.9	0.475	-125.9
800	0.656	-167.2	8.891	85.9	0.048	45.7	0.420	-135.4
1000	0.656	-172.6	7.097	80.3	0.054	47.6	0.405	-143.9
1200	0.653	-178.2	5.926	75.9	0.061	50.0	0.390	-149.6
1400	0.650	177.1	5.076	72.0	0.068	51.1	0.381	-155.5
1600	0.650	173.1	4.458	68.0	0.075	51.7	0.373	-159.7
1800	0.647	168.8	3.966	64.4	0.083	51.8	0.366	-163.8
2000	0.648	164.8	3.574	60.7	0.091	51.2	0.358	-167.0
2200	0.649	161.3	3.285	57.0	0.099	50.4	0.355	-172.0
2400	0.651	157.3	3.010	53.5	0.106	49.1	0.353	-175.9
2600	0.652	153.4	2.788	49.7	0.114	47.7	0.352	-179.9
2800	0.654	149.8	2.587	46.3	0.121	46.5	0.355	176.2
3000	0.658	146.0	2.423	42.8	0.128	44.6	0.360	171.9
3200	0.662	142.6	2.275	39.4	0.135	43.2	0.367	167.5
3400	0.669	139.2	2.138	36.2	0.142	41.2	0.378	163.5
3600	0.675	136.0	2.017	32.8	0.149	39.4	0.384	159.9
3800	0.681	132.9	1.909	29.7	0.154	37.7	0.397	156.6
4000	0.688	130.0	1.809	26.5	0.159	36.0	0.409	153.5
4200	0.696	127.3	1.721	23.6	0.164	34.2	0.419	150.5
4400	0.703	124.7	1.638	20.6	0.170	32.5	0.430	147.8
4600	0.712	122.2	1.563	17.8	0.175	30.7	0.442	145.3
4800	0.719	119.8	1.495	15.0	0.180	29.0	0.449	143.0
5000	0.724	117.4	1.436	12.2	0.184	27.2	0.458	140.8
5200	0.731	115.1	1.381	9.4	0.189	25.3	0.465	138.7
5400	0.735	112.9	1.331	6.8	0.195	23.8	0.473	136.7
5600	0.737	110.6	1.282	4.2	0.199	21.9	0.478	135.1
5800	0.740	108.3	1.244	1.6	0.204	20.1	0.485	132.8
6000	0.737	103.6	1.192	-2.3	0.207	17.0	0.491	128.5

SBFP450M

S パラメータ (エミッタ接地)

$V_{CE}=3V, I_C=40mA, Z_O=50\Omega$

Freq(MHz)	$ S_{11} $	$\angle S_{11}$	$ S_{21} $	$\angle S_{21}$	$ S_{12} $	$\angle S_{12}$	$ S_{22} $	$\angle S_{22}$
200	0.565	-138.3	33.353	118.2	0.021	50.9	0.608	-90.1
400	0.633	-159.8	18.809	99.4	0.028	50.5	0.486	-123.3
600	0.658	-168.9	12.695	89.2	0.035	53.7	0.467	-138.8
800	0.656	-175.2	9.547	83.8	0.042	57.0	0.426	-147.7
1000	0.657	-179.3	7.603	79.0	0.051	58.1	0.419	-155.1
1200	0.653	176.0	6.357	75.0	0.059	59.7	0.407	-159.9
1400	0.650	171.9	5.422	71.3	0.067	60.5	0.401	-165.3
1600	0.648	168.4	4.772	67.7	0.076	59.5	0.394	-169.2
1800	0.646	164.4	4.225	64.4	0.085	58.9	0.387	-172.7
2000	0.645	160.8	3.843	60.9	0.094	57.8	0.381	-176.1
2200	0.646	157.5	3.504	57.3	0.102	55.9	0.379	179.3
2400	0.647	153.8	3.218	53.9	0.111	54.5	0.378	175.9
2600	0.648	150.2	2.978	50.3	0.119	52.2	0.378	172.0
2800	0.649	146.8	2.770	47.1	0.127	50.3	0.381	168.3
3000	0.652	143.4	2.587	43.7	0.135	48.3	0.386	164.4
3200	0.656	140.0	2.428	40.5	0.142	46.1	0.394	160.4
3400	0.662	136.8	2.282	37.3	0.150	43.8	0.403	156.9
3600	0.668	133.8	2.152	34.0	0.155	41.7	0.412	153.3
3800	0.675	130.9	2.039	31.0	0.161	39.8	0.425	150.3
4000	0.682	128.1	1.930	28.1	0.167	37.7	0.434	147.4
4200	0.690	125.6	1.837	25.2	0.173	35.8	0.447	144.8
4400	0.697	123.1	1.746	22.4	0.178	33.7	0.455	141.8
4600	0.706	120.5	1.667	19.5	0.183	31.8	0.467	139.5
4800	0.713	118.3	1.598	16.8	0.188	29.8	0.474	137.7
5000	0.719	116.0	1.535	14.3	0.193	28.0	0.482	135.5
5200	0.725	113.7	1.476	11.6	0.197	26.2	0.488	133.3
5400	0.728	111.6	1.420	8.9	0.203	24.1	0.494	131.5
5600	0.730	109.4	1.376	6.5	0.208	22.5	0.501	129.7
5800	0.733	107.2	1.332	3.8	0.212	20.4	0.504	127.5
6000	0.730	102.5	1.277	0.0	0.213	17.0	0.509	123.7

SBFP450M

S パラメータ (エミッタ接地)

$V_{CE}=3V$, $I_C=70mA$, $Z_O=50\Omega$

Freq(MHz)	$ S_{11} $	$\angle S_{11}$	$ S_{21} $	$\angle S_{21}$	$ S_{12} $	$\angle S_{12}$	$ S_{22} $	$\angle S_{22}$
200	0.579	-152.1	35.449	114.7	0.017	54.6	0.578	-98.9
400	0.640	-167.2	19.475	97.3	0.025	56.7	0.477	-130.9
600	0.662	-173.8	13.051	87.8	0.032	61.0	0.469	-144.3
800	0.659	-179.1	9.810	82.8	0.041	64.0	0.432	-153.1
1000	0.658	177.4	7.823	78.3	0.049	64.4	0.430	-159.8
1200	0.655	173.2	6.515	74.3	0.059	64.9	0.419	-164.5
1400	0.654	169.3	5.569	71.0	0.068	64.8	0.411	-169.5
1600	0.650	166.1	4.878	67.6	0.076	63.9	0.407	-173.2
1800	0.647	162.3	4.340	64.4	0.086	62.2	0.400	-176.8
2000	0.646	158.8	3.923	60.9	0.095	60.5	0.394	-179.7
2200	0.647	155.7	3.583	57.6	0.104	58.7	0.392	175.9
2400	0.647	152.1	3.297	54.1	0.113	56.6	0.391	172.2
2600	0.648	148.6	3.053	50.7	0.122	54.5	0.391	168.7
2800	0.649	145.3	2.843	47.5	0.130	52.1	0.396	165.0
3000	0.653	142.0	2.653	44.1	0.139	49.8	0.401	161.5
3200	0.657	138.7	2.488	40.9	0.145	47.7	0.408	157.3
3400	0.663	135.6	2.341	37.9	0.152	45.4	0.418	154.2
3600	0.669	132.6	2.206	34.6	0.159	42.7	0.426	150.7
3800	0.675	129.9	2.090	31.6	0.165	40.8	0.439	147.7
4000	0.682	127.3	1.980	28.7	0.171	38.5	0.446	144.7
4200	0.691	124.7	1.879	25.9	0.177	36.8	0.458	142.3
4400	0.698	122.2	1.790	23.1	0.181	34.4	0.468	139.7
4600	0.706	119.8	1.709	20.3	0.187	32.3	0.480	137.0
4800	0.713	117.4	1.638	17.6	0.192	30.4	0.487	135.3
5000	0.719	115.3	1.573	15.1	0.197	28.3	0.493	133.4
5200	0.724	113.0	1.514	12.5	0.201	26.7	0.499	131.4
5400	0.727	111.0	1.457	9.8	0.206	24.5	0.506	129.4
5600	0.730	108.7	1.413	7.4	0.211	22.6	0.512	127.5
5800	0.732	106.5	1.368	4.9	0.216	20.7	0.513	125.6
6000	0.728	101.9	1.308	1.1	0.217	17.0	0.519	121.4

SBFP450M

SPICE パラメータ

model : Gummel-Poon

Parameter	Value	Unit	Parameter	Value	Unit
IS	0.13125f	A	TF	7.5068p	S
BF	76.123		XTF	0.69972	
NF	0.79652		VTF	0.66148	V
VAF	24.165	V	ITF	0.017655m	A
IKF	0.58905	A	PTF	0	deg
ISE	28.341f	A	CJC	1.0495p	F
NE	1.5563		VJC	1.1487	V
BR	21.254		MJC	0.50644	
NR	1.2966		XCJC	0.28285	
VAR	13.461	V	TR	2.6912n	S
IKR	258.78m	A	FC	0.91274	
ISC	12.292a	A	CJS	0	F
NC	0.70543		VJS	0.75	V
RB	5.403	Ω	MJS	0	
IRB	13.181 μ	A	CC	20f	F
RBM	2.1659	Ω	Cbc	20f	F
RE	0.45346	Ω	Cbe	20f	F
RC	0.50084	Ω	Lb	0.80n	H
XTB	0		Lc	0.84n	H
EG	1.11	eV	Le	1.0n	H
XTI	3				
CJE	3.2276f	F			
VJE	0.95292	V			
MJE	0.48672				

回路図

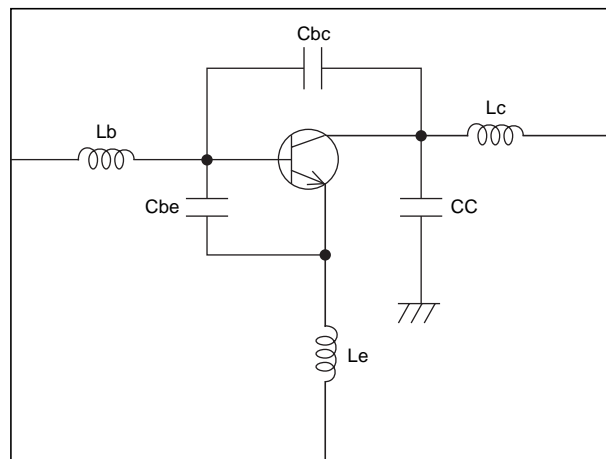

* 本資料に掲載している SPICE パラメータ・データは当社の任意条件のもとに抽出した参考データです。このため保証するものではありません。本パラメータは開発・設計等の目安としてご利用ください。

- 本書記載の製品は、定められた条件下において、記載部品単体の性能・特性・機能などを規定するものであり、お客様の製品（機器）での性能・特性・機能などを保証するものではありません。部品単体の評価では予測できない症状・事態を確認するためにも、お客様の製品で必要とされる評価・試験を必ず行って下さい。
- 弊社は、高品質・高信頼性の製品を供給することに努めております。しかし、半導体製品はある確率で故障が生じてしまいます。この故障が原因となり、人命にかかわる事故、発煙・発火事故、他の物品に損害を与えてしまう事故などを引き起こす可能性があります。機器設計時には、このような事故を起こさないような、保護回路・誤動作防止回路等の安全設計、冗長設計・機構設計等の安全対策を行って下さい。
- 本書記載の製品が、外国為替及び外国貿易法に定める規制貨物（役務を含む）に該当する場合、輸出する際に同法に基づく輸出許可が必要です。
- 弊社の承諾なしに、本書の一部または全部を、転載または複製することを禁止します。
- 本書に記載された内容は、製品改善および技術改良等により将来予告なしに変更することがあります。したがって、ご使用の際には、「納入仕様書」でご確認下さい。
- この資料の情報（掲載回路および回路定数を含む）は一例を示すもので、量産セットとしての設計を保証するものではありません。また、この資料は正確かつ信頼すべきものであると確信しておりますが、その使用にあたって第三者の工業所有権その他の権利の実施に対する保証を行うものではありません。