

Fiber Optic PIN Photodiode in SMA Receptacle Type OPF471

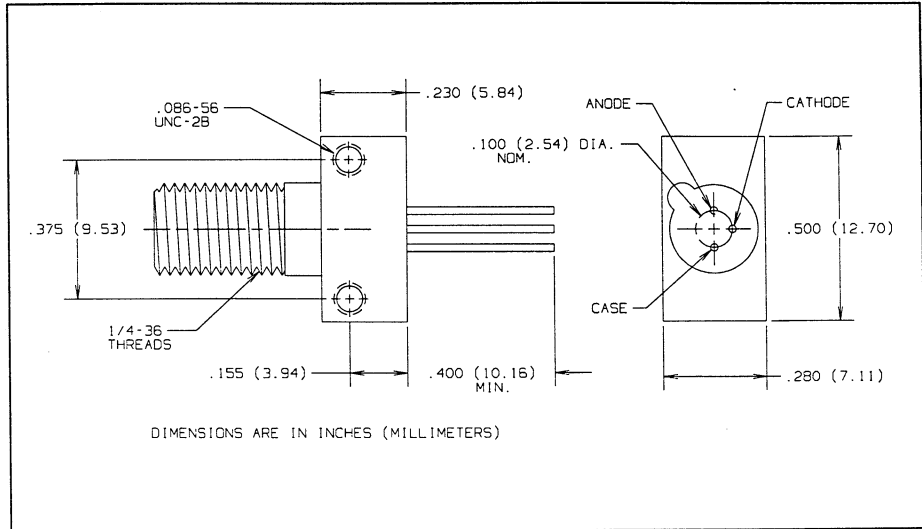
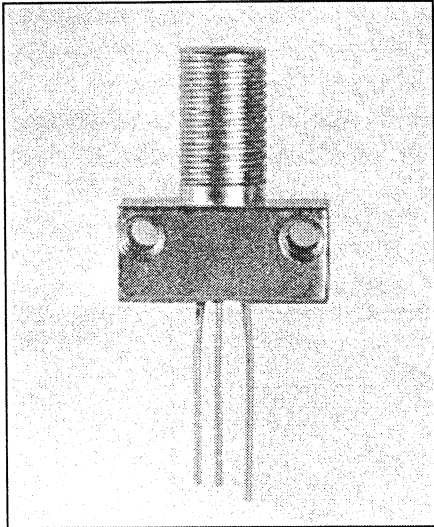

Features

- Component pre-mounted and ready to use
- Pre-tested with fiber to assure performance
- Popular SMA style receptacle

Description

The OPF471 consists of a low cost plastic cap PIN photodiode pre-mounted and aligned in an SMA receptacle. This configuration is designed for PC board or panel mounting. Includes lock washer and jam nut, two 2-56 screws, and dust cap.

The PIN Photodiodes are designed to interface with multimode optical fibers from 50/125 to 200/300 microns.

Absolute Maximum Ratings ($T_A = 25^\circ\text{C}$ unless otherwise noted)

Reverse Voltage	100 VDC
Continuous Power Dissipation	200 mW ⁽¹⁾
Storage Temperature Range	-55° C to +100° C
Operating Temperature Range	-40° C to +85° C
Lead Soldering Temperature [1/16 inch (1.6 mm) from case for 5 sec. with soldering iron]	240° C ⁽²⁾

Notes:

- (1) Derate linearly @ 2.0 mW/° C above 25° C.
- (2) RMA flux is recommended. Duration can be extended to 10 sec. max when flow soldering.
- (3) Test @ $V_R = 5\text{ V}$ with 50/125 micron, 0.20 N.A. fiber, @ 10 μW optical power @ 850 nm. Responsivity levels apply to 50 μm , 62.5 μm and 100 μm core optical fibers.
- (4) $R_L = 50\ \Omega$. 10% -90%.

Typical Performance Curves

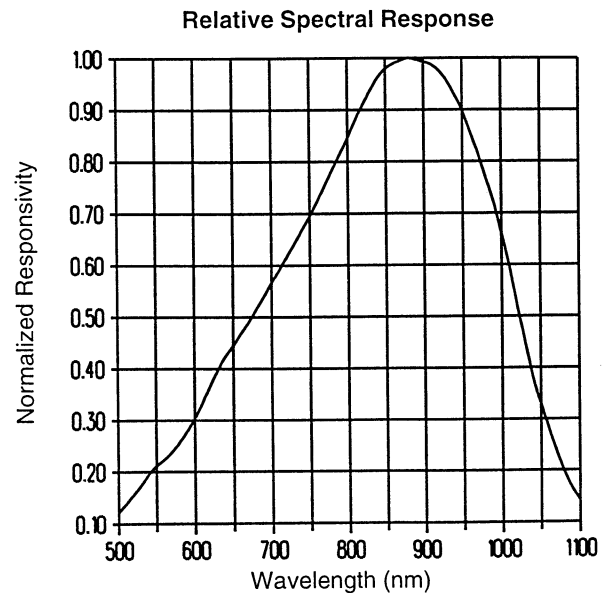

Type OPF471

Electrical Characteristics ($T_A = 25^\circ\text{C}$ unless otherwise noted)

SYMBOL	PARAMETER	MIN	TYP	MAX	UNITS	TEST CONDITIONS
R	Flux Responsivity	0.45	0.55		A/W	$V_R = 5.0\text{ V}^{(3)}$
I_D	Dark Current		0.1	5.0	nA	$V_R = 5.0\text{ V}$
λ_p	Peak Response Wavelength		880		nm	
t_r	Output Rise Time		6.0		ns	$V_R = 15\text{ V}^{(4)}$
C_T	Total Capacitance		3.0		pF	$V_R = 20\text{ V}$

TYPICAL PERFORMANCE CURVES

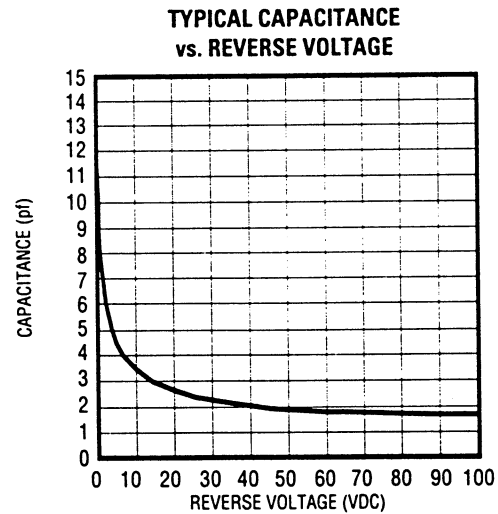
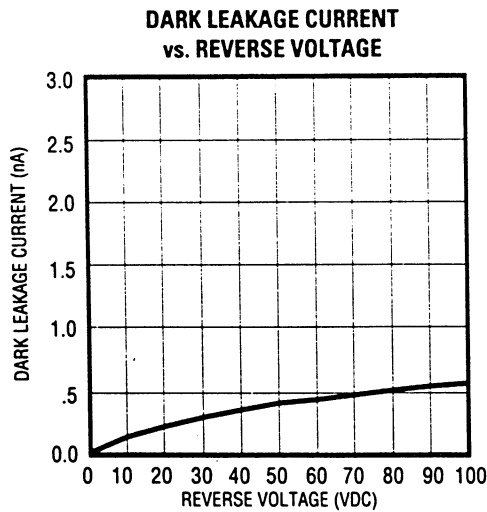
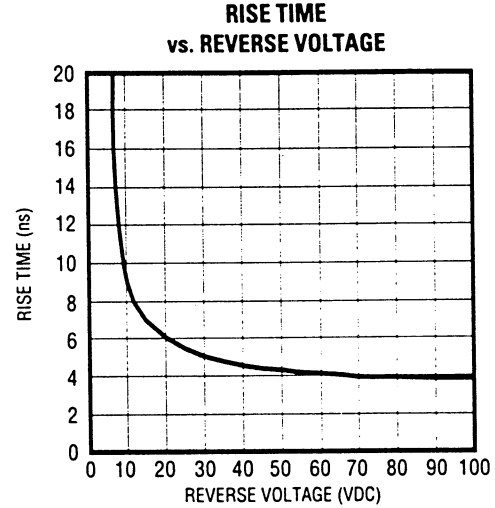
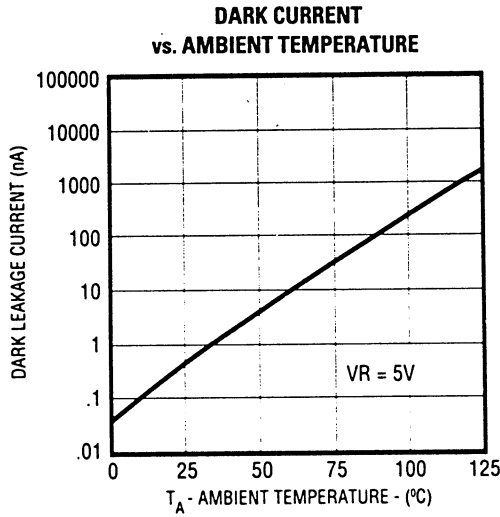

FIBER OPTIC
COMPONENTS

Optek reserves the right to make changes at any time in order to improve design and to supply the best product possible.

Optek Technology, Inc.

1215 W. Crosby Road

Carrollton, Texas 75006

(972)323-2200

Fax (972)323-2396