

# NTMSD2P102LR2

## FETKY™

### Power MOSFET and Schottky Diode Dual SO-8 Package

#### Features

- High Efficiency Components in a Single SO-8 Package
- High Density Power MOSFET with Low  $R_{DS(on)}$ , Schottky Diode with Low  $V_F$
- Logic Level Gate Drive
- Independent Pin-Outs for MOSFET and Schottky Die Allowing for Flexibility in Application Use
- Less Component Placement for Board Space Savings
- SO-8 Surface Mount Package, Mounting Information for SO-8 Package Provided
- Pb-Free Package is Available

#### Applications

- Power Management in Portable and Battery-Powered Products, i.e.: Computers, Printers, PCMCIA Cards, Cellular and Cordless Telephones

#### MOSFET MAXIMUM RATINGS ( $T_J = 25^\circ\text{C}$ unless otherwise noted)

| Rating  | Symbol          | Value       | Unit               |
|---|-----------------|-------------|--------------------|
| Drain-to-Source Voltage   | $V_{DSS}$       | -20         | V                  |
| Gate-to-Source Voltage – Continuous   | $V_{GS}$        | $\pm 10$    | V                  |
| Thermal Resistance, Junction-to-Ambient (Note 1)  | $R_{\theta JA}$ | 175         | $^\circ\text{C/W}$ |
| Total Power Dissipation @ $T_A = 25^\circ\text{C}$  | $P_D$           | 0.71        | W                  |
| Continuous Drain Current @ $T_A = 25^\circ\text{C}$   | $I_D$           | -2.3        | A                  |
| Continuous Drain Current @ $T_A = 100^\circ\text{C}$  | $I_D$           | -1.45       | A                  |
| Pulsed Drain Current (Note 4)   | $I_{DM}$        | -9.0        | A                  |
| Thermal Resistance, Junction-to-Ambient (Note 2)  | $R_{\theta JA}$ | 105         | $^\circ\text{C/W}$ |
| Total Power Dissipation @ $T_A = 25^\circ\text{C}$  | $P_D$           | 1.19        | W                  |
| Continuous Drain Current @ $T_A = 25^\circ\text{C}$   | $I_D$           | -2.97       | A                  |
| Continuous Drain Current @ $T_A = 100^\circ\text{C}$  | $I_D$           | -1.88       | A                  |
| Pulsed Drain Current (Note 4)   | $I_{DM}$        | -12         | A                  |
| Thermal Resistance, Junction-to-Ambient (Note 3)  | $R_{\theta JA}$ | 62.5        | $^\circ\text{C/W}$ |
| Total Power Dissipation @ $T_A = 25^\circ\text{C}$  | $P_D$           | 2.0         | W                  |
| Continuous Drain Current @ $T_A = 25^\circ\text{C}$   | $I_D$           | -3.85       | A                  |
| Continuous Drain Current @ $T_A = 100^\circ\text{C}$  | $I_D$           | -2.43       | A                  |
| Pulsed Drain Current (Note 4)   | $I_{DM}$        | -15         | A                  |
| Operating and Storage Temperature Range   | $T_J, T_{stg}$  | -55 to +150 | $^\circ\text{C}$   |
| Single Pulse Drain-to-Source Avalanche Energy – Starting $T_J = 25^\circ\text{C}$<br>( $V_{DD} = -20\text{ Vdc}$ , $V_{GS} = -4.5\text{ Vdc}$ ,<br>Peak $I_L = -5.0\text{ Apk}$ , $L = 28\text{ mH}$ , $R_G = 25\ \Omega$ ) | $E_{AS}$        | 350         | mJ                 |
| Maximum Lead Temperature for Soldering Purposes, 1/8" from Case for 10 Seconds  | $T_L$           | 260         | $^\circ\text{C}$   |

Stresses exceeding Maximum Ratings may damage the device. Maximum Ratings are stress ratings only. Functional operation above the Recommended Operating Conditions is not implied. Extended exposure to stresses above the Recommended Operating Conditions may affect device reliability.

1. Minimum FR-4 or G-10 PCB, Steady State.
2. Mounted onto a 2" square FR-4 Board (1" sq. 2 oz Cu 0.06" thick single sided), Steady State.
3. Mounted onto a 2" square FR-4 Board (1" sq. 2 oz Cu 0.06" thick single sided),  $t \leq 10$  seconds.
4. Pulse Test: Pulse Width = 300  $\mu\text{s}$ , Duty Cycle = 2%.



**ON Semiconductor®**

<http://onsemi.com>

#### MOSFET

**-2.3 AMPERES, -20 VOLTS**

**90 m $\Omega$  @  $V_{GS} = -4.5\text{ V}$**

#### SCHOTTKY DIODE

**2.0 AMPERES, 20 VOLTS**

**580 mV @  $I_F = 2.0\text{ A}$**



**SO-8  
CASE 751  
STYLE 18**

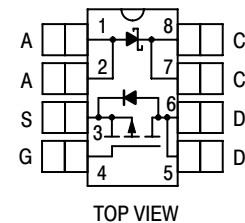

#### MARKING DIAGRAM & PIN ASSIGNMENTS

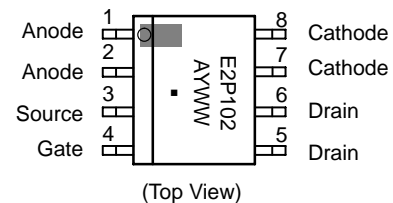

E2P102 = Device Code  
A = Assembly Location  
Y = Year  
WW = Work Week  
▪ = Pb-Free Package

#### ORDERING INFORMATION

| Device         | Package           | Shipping†        |
|----------------|-------------------|------------------|
| NTMSD2P102LR2  | SO-8              | 2500/Tape & Reel |
| NTMSD2P102LR2G | SO-8<br>(Pb-Free) | 2500/Tape & Reel |

†For information on tape and reel specifications, including part orientation and tape sizes, please refer to our Tape and Reel Packaging Specification Brochure, BRD8011/D.

# NTMSD2P102LR2

## SCHOTTKY MAXIMUM RATINGS (T<sub>J</sub> = 25°C unless otherwise noted)

| Rating   | Symbol                             | Value | Unit |
|--|------------------------------------|-------|------|
| Peak Repetitive Reverse Voltage<br>DC Blocking Voltage   | V <sub>RRM</sub><br>V <sub>R</sub> | 20    | V    |
| Average Forward Current (Note 5)<br>(Rated V <sub>R</sub> , T <sub>A</sub> = 100°C)                                    | I <sub>O</sub>                     | 1.0   | A    |
| Peak Repetitive Forward Current<br>(Note 5) (Rated V <sub>R</sub> , Square Wave, 20 kHz, T <sub>A</sub> = 105°C)       | I <sub>FRM</sub>                   | 2.0   | A    |
| Non-Repetitive Peak Surge Current (Note 5)<br>(Surge Applied at Rated Load Conditions, Half-Wave, Single Phase, 60 Hz) | I <sub>FSM</sub>                   | 20    | A    |

## ELECTRICAL CHARACTERISTICS (T<sub>J</sub> = 25°C unless otherwise noted) (Note 6)

| Characteristic | Symbol | Min | Typ | Max | Unit |
|----------------|--------|-----|-----|-----|------|
|----------------|--------|-----|-----|-----|------|

### OFF CHARACTERISTICS

|  |                      |          |            |             |              |
|--|----------------------|----------|------------|-------------|--------------|
| Drain-to-Source Breakdown Voltage<br>(V <sub>GS</sub> = 0 Vdc, I <sub>D</sub> = -250 μAdc)<br>Temperature Coefficient (Positive)   | V <sub>(BR)DSS</sub> | -20<br>- | -<br>-12.7 | -<br>-      | Vdc<br>mV/°C |
| Zero Gate Voltage Drain Current<br>(V <sub>DS</sub> = -16 Vdc, V <sub>GS</sub> = 0 Vdc, T <sub>J</sub> = 25°C)<br>(V <sub>DS</sub> = -16 Vdc, V <sub>GS</sub> = 0 Vdc, T <sub>J</sub> = 125°C) | I <sub>DSS</sub>     | -<br>-   | -<br>-     | -1.0<br>-25 | μAdc         |
| Zero Gate Voltage Drain Current<br>(V <sub>GS</sub> = 0 Vdc, V <sub>DS</sub> = -20 Vdc, T <sub>J</sub> = 25°C)   | I <sub>DSS</sub>     | -        | -          | -2.0        | μAdc         |
| Gate-Body Leakage Current<br>(V <sub>GS</sub> = -10 Vdc, V <sub>DS</sub> = 0 Vdc)  | I <sub>GSS</sub>     | -        | -          | -100        | nAdc         |
| Gate-Body Leakage Current<br>(V <sub>GS</sub> = +10 Vdc, V <sub>DS</sub> = 0 Vdc)  | I <sub>GSS</sub>     | -        | -          | 100         | nAdc         |

### ON CHARACTERISTICS

|   |                     |             |                         |                         |              |
|---|---------------------|-------------|-------------------------|-------------------------|--------------|
| Gate Threshold Voltage<br>(V <sub>DS</sub> = V <sub>GS</sub> , I <sub>D</sub> = -250 μAdc)<br>Temperature Coefficient (Negative)  | V <sub>GS(th)</sub> | -0.5<br>-   | -0.90<br>2.5            | -1.5<br>-               | Vdc<br>mV/°C |
| Static Drain-to-Source On-State Resistance<br>(V <sub>GS</sub> = -4.5 Vdc, I <sub>D</sub> = -2.4 Adc)<br>(V <sub>GS</sub> = -2.7 Vdc, I <sub>D</sub> = -1.2 Adc)<br>(V <sub>GS</sub> = -2.5 Vdc, I <sub>D</sub> = -1.2 Adc) | R <sub>DS(on)</sub> | -<br>-<br>- | 0.070<br>0.100<br>0.110 | 0.090<br>0.130<br>0.150 | Ω            |
| Forward Transconductance<br>(V <sub>DS</sub> = -10 Vdc, I <sub>D</sub> = -1.2 Adc)  | g <sub>FS</sub>     | -           | 4.2                     | -                       | Mhos         |

### DYNAMIC CHARACTERISTICS

|                              |   |                  |   |     |     |    |
|------------------------------|---|------------------|---|-----|-----|----|
| Input Capacitance            | (V <sub>DS</sub> = -16 Vdc, V <sub>GS</sub> = 0 Vdc, f = 1.0 MHz) | C <sub>iss</sub> | - | 550 | 750 | pF |
| Output Capacitance           |   | C <sub>oss</sub> | - | 200 | 300 |    |
| Reverse Transfer Capacitance |   | C <sub>rss</sub> | - | 100 | 175 |    |

5. Mounted onto a 2" square FR-4 Board (1" sq. 2 oz Cu 0.06" thick single sided), t ≤ 10 seconds.
6. Handling precautions to protect against electrostatic discharge is mandatory.

# NTMSD2P102LR2

## ELECTRICAL CHARACTERISTICS ( $T_J = 25^\circ\text{C}$ unless otherwise noted) (continued) (Note 7)

| Characteristic                                 | Symbol  | Min          | Typ | Max | Unit |    |
|--|---|--------------|-----|-----|------|----|
| <b>SWITCHING CHARACTERISTICS</b> (Notes 8 & 9) |   |              |     |     |      |    |
| Turn-On Delay Time                             | $(V_{DD} = -10\text{ Vdc}, I_D = -2.4\text{ Adc}, V_{GS} = -4.5\text{ Vdc}, R_G = 6.0\ \Omega)$ | $t_{d(on)}$  | –   | 10  | 20   | ns |
| Rise Time                                      |   | $t_r$        | –   | 35  | 65   |    |
| Turn-Off Delay Time                            |   | $t_{d(off)}$ | –   | 33  | 60   |    |
| Fall Time                                      |   | $t_f$        | –   | 29  | 55   |    |
| Turn-On Delay Time                             | $(V_{DD} = -10\text{ Vdc}, I_D = -1.2\text{ Adc}, V_{GS} = -2.7\text{ Vdc}, R_G = 6.0\ \Omega)$ | $t_{d(on)}$  | –   | 15  | –    | ns |
| Rise Time                                      |   | $t_r$        | –   | 40  | –    |    |
| Turn-Off Delay Time                            |   | $t_{d(off)}$ | –   | 35  | –    |    |
| Fall Time                                      |   | $t_f$        | –   | 35  | –    |    |
| Total Gate Charge                              | $(V_{DS} = -16\text{ Vdc}, V_{GS} = -4.5\text{ Vdc}, I_D = -2.4\text{ Adc})$                    | $Q_{tot}$    | –   | 10  | 18   | nC |
| Gate-Source Charge                             |   | $Q_{gs}$     | –   | 1.5 | –    |    |
| Gate-Drain Charge                              |   | $Q_{gd}$     | –   | 5.0 | –    |    |

## BODY-DRAIN DIODE RATINGS (Note 8)

|                                |   |          |   |                |           |               |
|--------------------------------|---|----------|---|----------------|-----------|---------------|
| Diode Forward On-Voltage       | $(I_S = -2.4\text{ Adc}, V_{GS} = 0\text{ Vdc})$<br>$(I_S = -2.4\text{ Adc}, V_{GS} = 0\text{ Vdc}, T_J = 125^\circ\text{C})$ | $V_{SD}$ | – | –0.88<br>–0.75 | –1.0<br>– | Vdc           |
| Reverse Recovery Time          | $(I_S = -2.4\text{ Adc}, V_{GS} = 0\text{ Vdc}, di_S/dt = 100\text{ A}/\mu\text{s})$  | $t_{rr}$ | – | 37             | –         | ns            |
|                                |   | $t_a$    | – | 16             | –         |               |
|                                |   | $t_b$    | – | 21             | –         |               |
| Reverse Recovery Stored Charge |   | $Q_{RR}$ | – | 0.025          | –         | $\mu\text{C}$ |

## SCHOTTKY RECTIFIER ELECTRICAL CHARACTERISTICS ( $T_J = 25^\circ\text{C}$ unless otherwise noted) (Note 8)

|                                       |  |         |  |   |                        |
|---------------------------------------|--|---------|--|---|------------------------|
| Maximum Instantaneous Forward Voltage | $I_F = 1.0\text{ Adc}$<br>$I_F = 2.0\text{ Adc}$ | $V_F$   | <b><math>T_J = 25^\circ\text{C}</math></b> | <b><math>T_J = 125^\circ\text{C}</math></b> | V                      |
|                                       |  |         | 0.47<br>0.58                               | 0.39<br>0.53                                |                        |
| Maximum Instantaneous Reverse Current | $V_R = 20\text{ Vdc}$                            | $I_R$   | <b><math>T_J = 25^\circ\text{C}</math></b> | <b><math>T_J = 125^\circ\text{C}</math></b> | mA                     |
|                                       |  |         | 0.05                                       | 10  |                        |
| Maximum Voltage Rate of Change        | $V_R = 20\text{ Vdc}$                            | $dV/dt$ | 10,000                                     |   | $\text{V}/\mu\text{s}$ |

7. Handling precautions to protect against electrostatic discharge is mandatory.
8. Indicates Pulse Test: Pulse Width = 300  $\mu\text{s}$  max, Duty Cycle = 2%.
9. Switching characteristics are independent of operating junction temperature.

# NTMSD2P102LR2

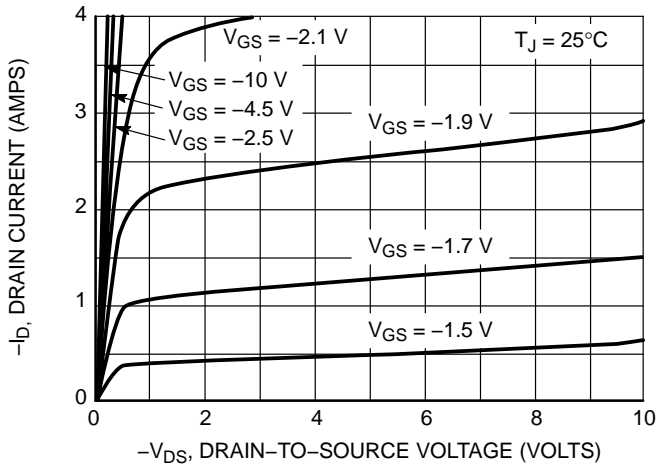

Figure 1. On-Region Characteristics.

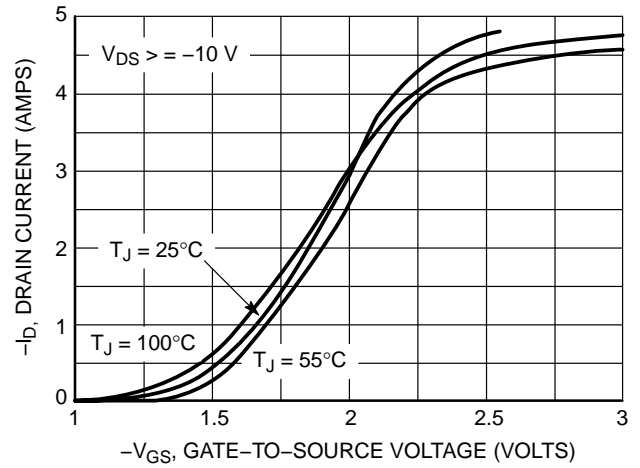

Figure 2. Transfer Characteristics.

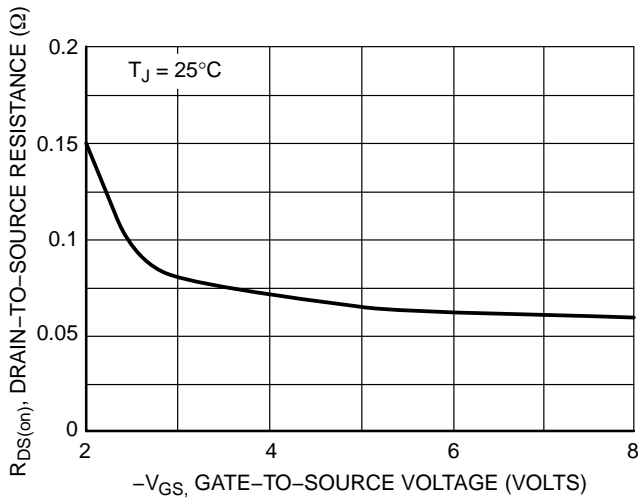

Figure 3. On-Resistance vs. Gate-to-Source Voltage.

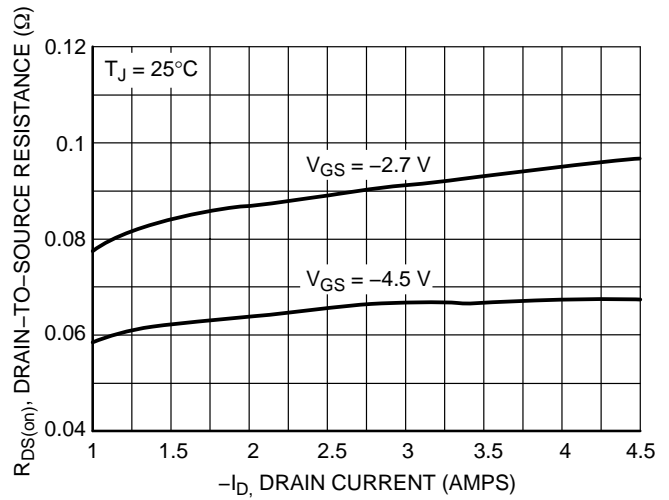

Figure 4. On-Resistance vs. Drain Current and Gate Voltage.

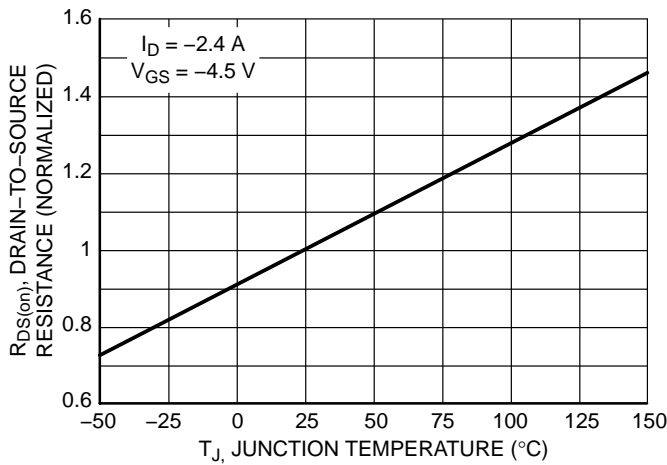

Figure 5. On-Resistance Variation with Temperature.

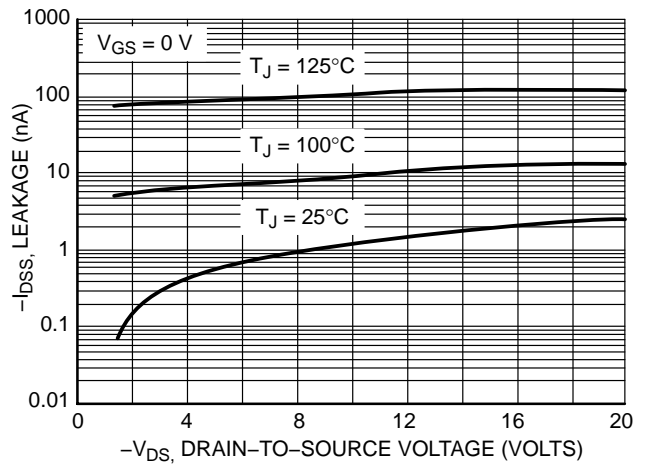

Figure 6. Drain-to-Source Leakage Current vs. Voltage.

# NTMSD2P102LR2

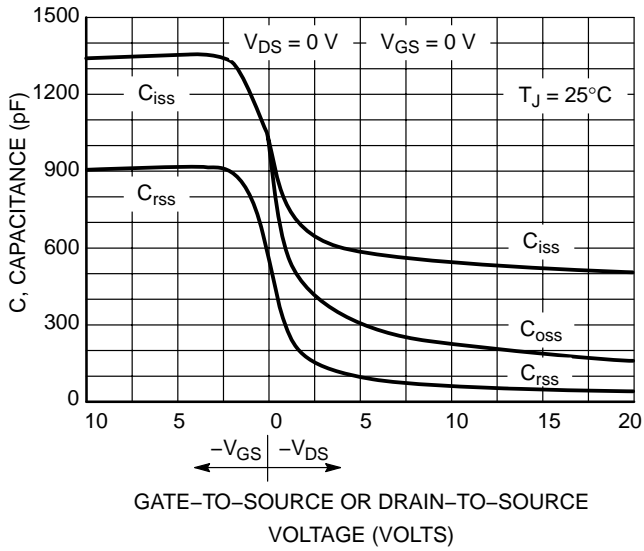

Figure 7. Capacitance Variation

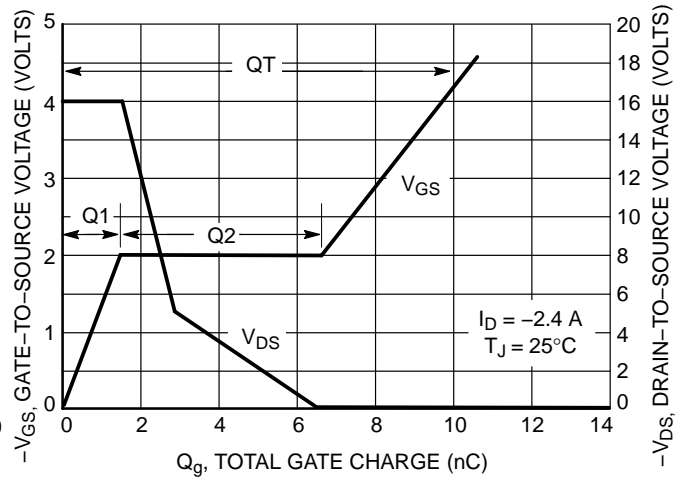

Figure 8. Gate-to-Source and Drain-to-Source Voltage versus Total Charge

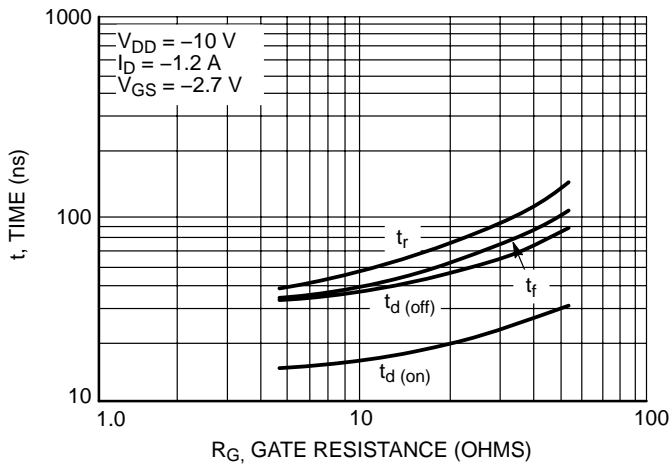

Figure 9. Resistive Switching Time Variation versus Gate Resistance

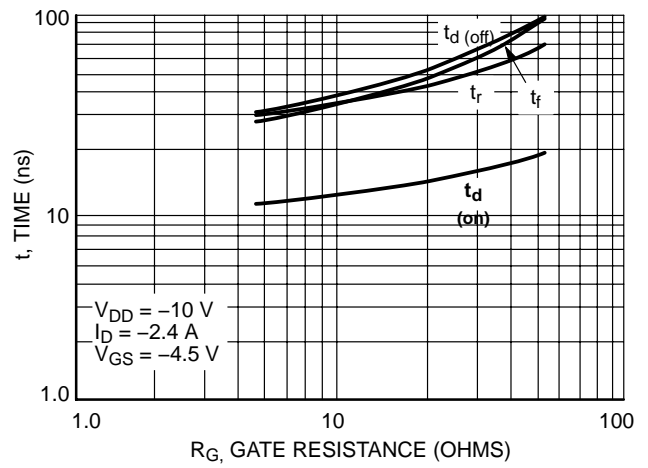

Figure 10. Resistive Switching Time Variation versus Gate Resistance

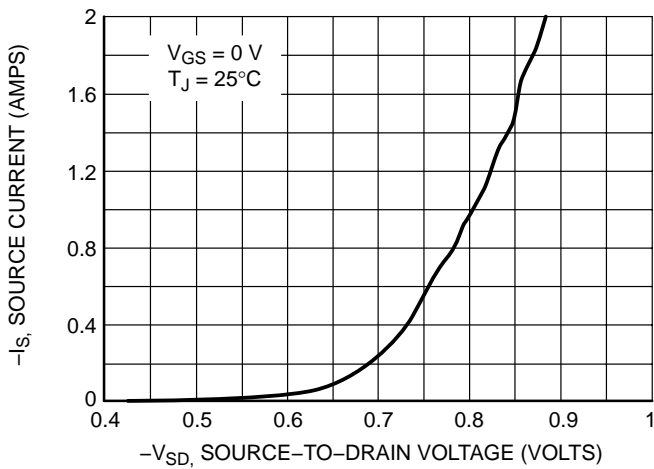

Figure 11. Diode Forward Voltage versus Current

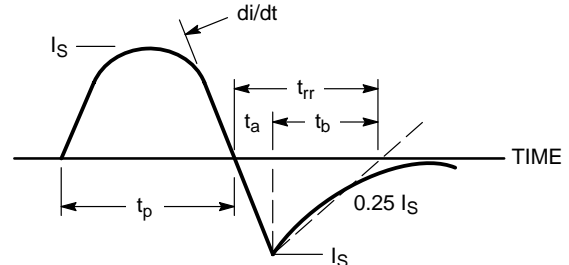

Figure 12. Diode Reverse Recovery Waveform

# NTMSD2P102LR2

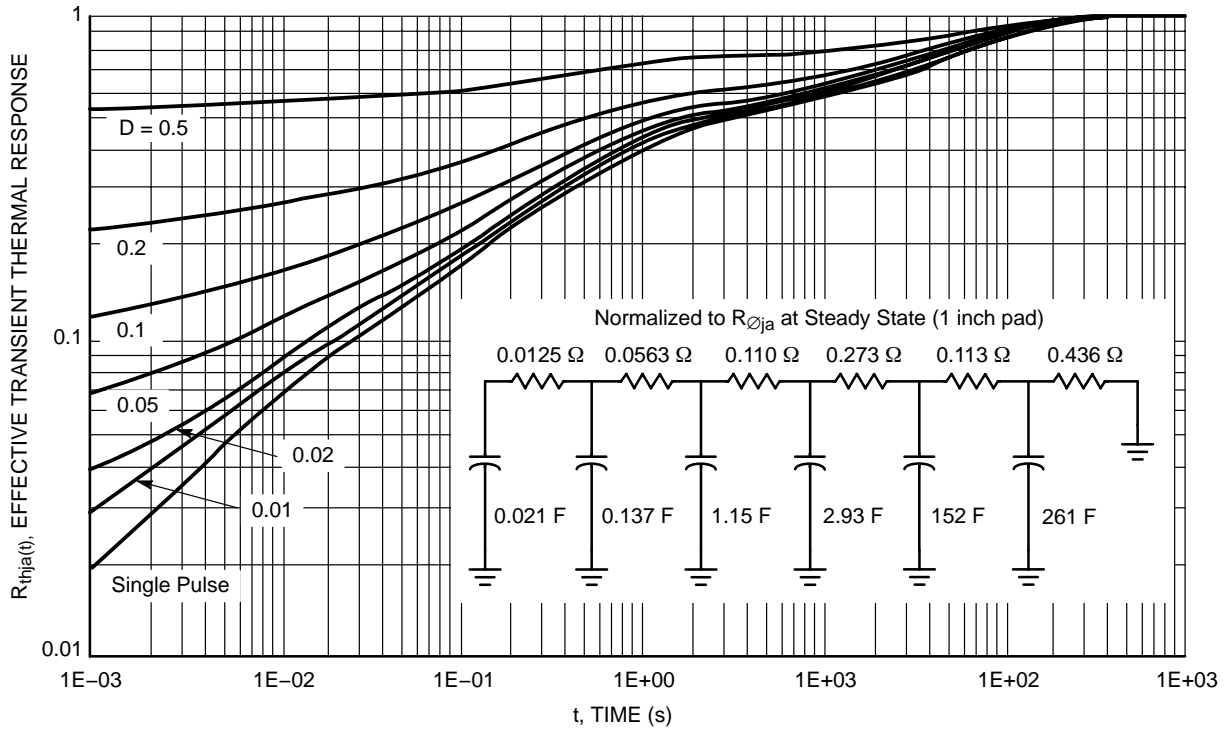

Figure 13. FET Thermal Response

## TYPICAL SCHOTTKY ELECTRICAL CHARACTERISTICS

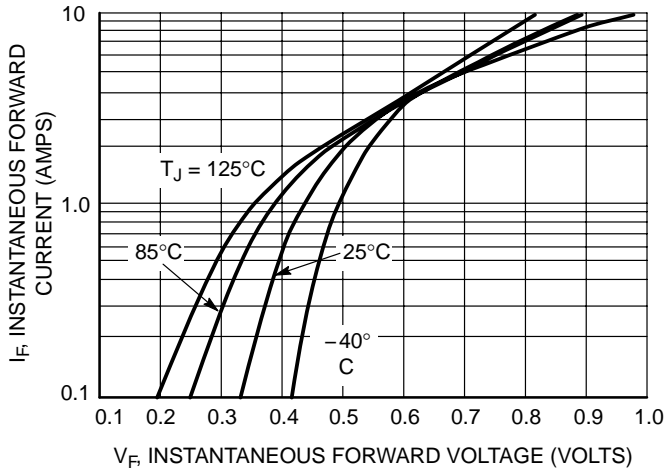

Figure 14. Typical Forward Voltage

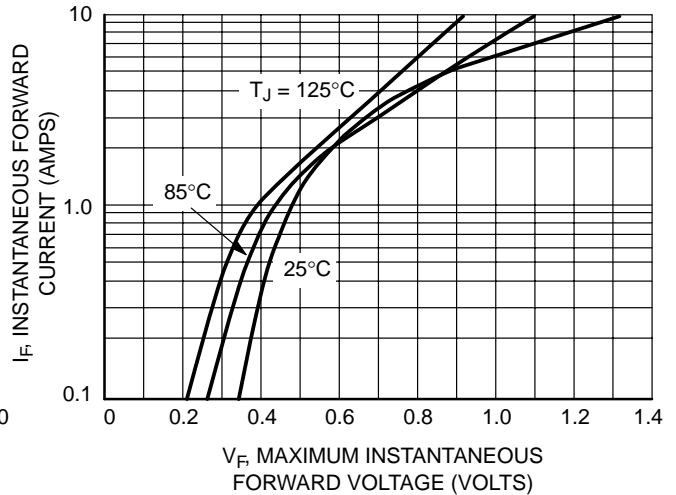

Figure 15. Maximum Forward Voltage

# NTMSD2P102LR2

## TYPICAL SCHOTTKY ELECTRICAL CHARACTERISTICS

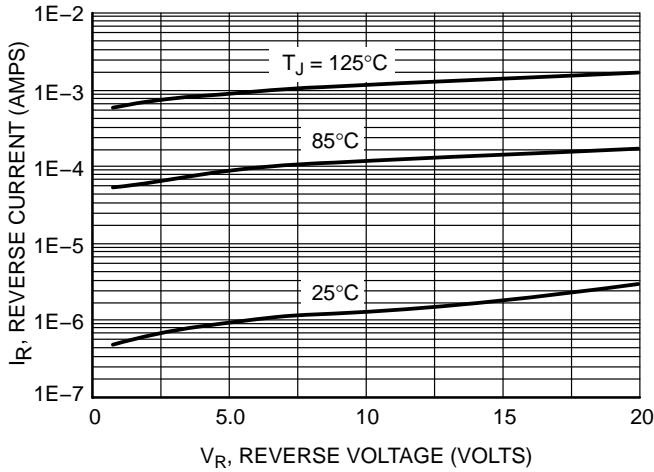

Figure 16. Typical Reverse Current

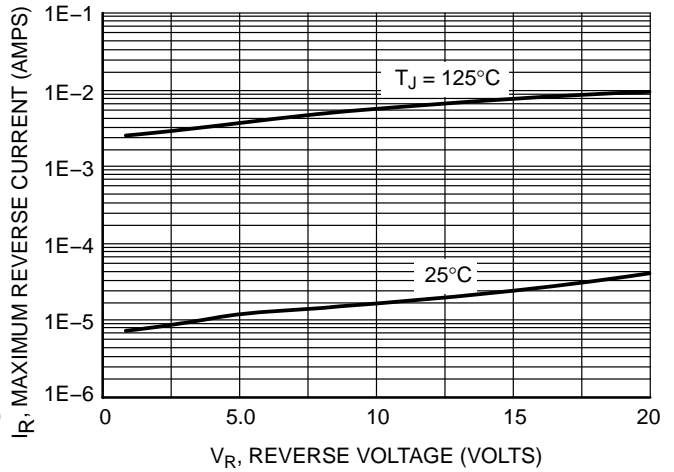

Figure 17. Maximum Reverse Current

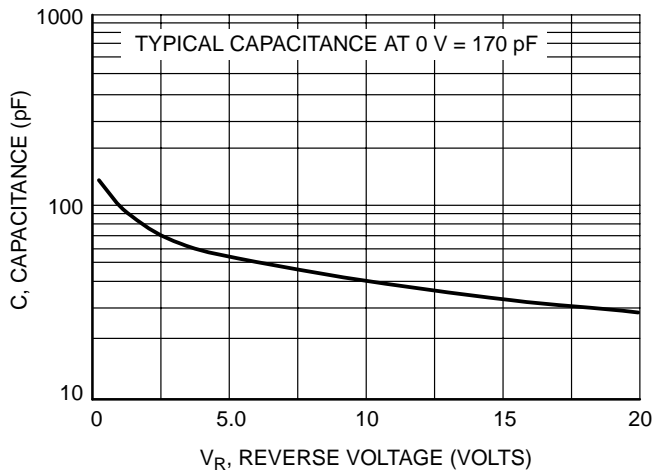

Figure 18. Typical Capacitance

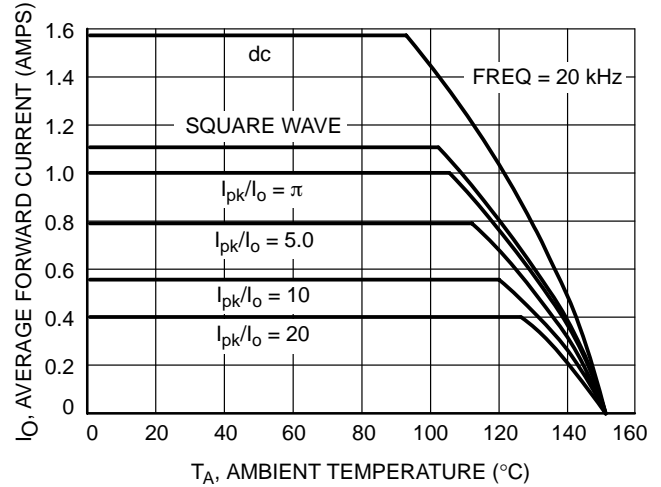

Figure 19. Current Derating

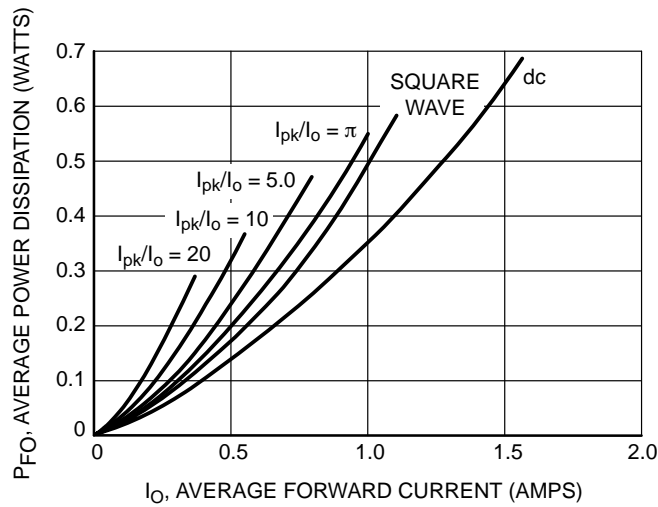

Figure 20. Forward Power Dissipation

# NTMSD2P102LR2

## TYPICAL SCHOTTKY ELECTRICAL CHARACTERISTICS

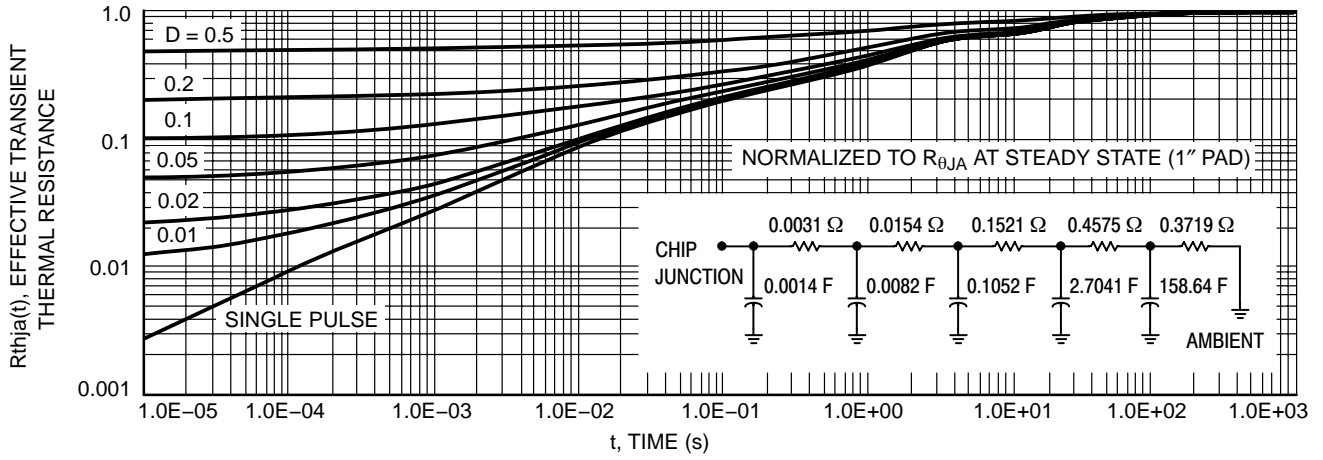

Figure 21. Schottky Thermal Response



# NTMSD2P102LR2

## PACKAGE DIMENSIONS

SOIC-8 NB  
CASE 751-07  
ISSUE AH

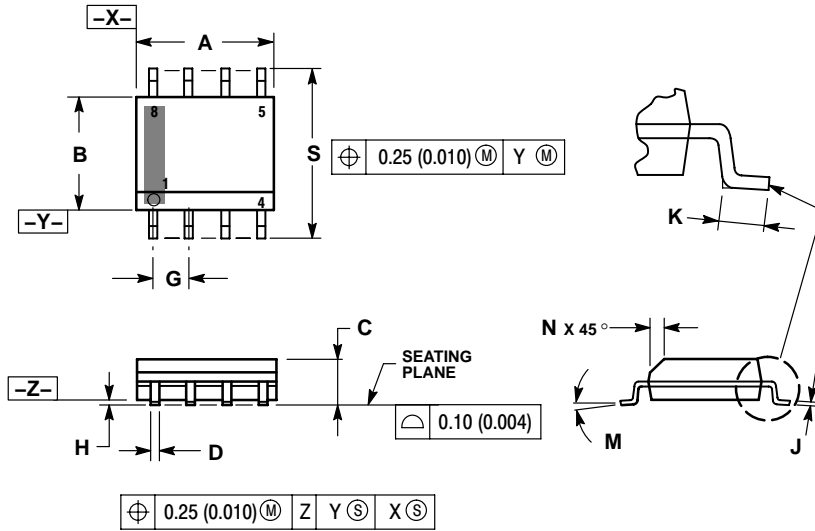

### NOTES:

1. DIMENSIONING AND TOLERANCING PER ANSI Y14.5M, 1982.
2. CONTROLLING DIMENSION: MILLIMETER.
3. DIMENSION A AND B DO NOT INCLUDE MOLD PROTRUSION.
4. MAXIMUM MOLD PROTRUSION 0.15 (0.006) PER SIDE.
5. DIMENSION D DOES NOT INCLUDE DAMBAR PROTRUSION. ALLOWABLE DAMBAR PROTRUSION SHALL BE 0.127 (0.005) TOTAL IN EXCESS OF THE D DIMENSION AT MAXIMUM MATERIAL CONDITION.
6. 751-01 THRU 751-06 ARE OBSOLETE. NEW STANDARD IS 751-07.

| DIM | MILLIMETERS |      | INCHES    |       |
|-----|-------------|------|-----------|-------|
|     | MIN         | MAX  | MIN       | MAX   |
| A   | 4.80        | 5.00 | 0.189     | 0.197 |
| B   | 3.80        | 4.00 | 0.150     | 0.157 |
| C   | 1.35        | 1.75 | 0.053     | 0.069 |
| D   | 0.33        | 0.51 | 0.013     | 0.020 |
| G   | 1.27 BSC    |      | 0.050 BSC |       |
| H   | 0.10        | 0.25 | 0.004     | 0.010 |
| J   | 0.19        | 0.25 | 0.007     | 0.010 |
| K   | 0.40        | 1.27 | 0.016     | 0.050 |
| M   | 0°          | 8°   | 0°        | 8°    |
| N   | 0.25        | 0.50 | 0.010     | 0.020 |
| S   | 5.80        | 6.20 | 0.228     | 0.244 |

### STYLE 18:

- PIN 1. ANODE
- 2. ANODE
- 3. SOURCE
- 4. GATE
- 5. DRAIN
- 6. DRAIN
- 7. CATHODE
- 8. CATHODE

### SOLDERING FOOTPRINT\*

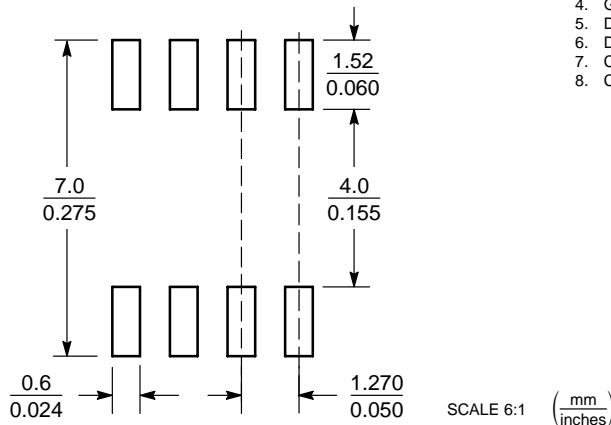

\*For additional information on our Pb-Free strategy and soldering details, please download the ON Semiconductor Soldering and Mounting Techniques Reference Manual, SOLDERRM/D.

FETKY is a trademark of International Rectifier Corporation.

ON Semiconductor and are registered trademarks of Semiconductor Components Industries, LLC (SCILLC). SCILLC reserves the right to make changes without further notice to any products herein. SCILLC makes no warranty, representation or guarantee regarding the suitability of its products for any particular purpose, nor does SCILLC assume any liability arising out of the application or use of any product or circuit, and specifically disclaims any and all liability, including without limitation special, consequential or incidental damages. "Typical" parameters which may be provided in SCILLC data sheets and/or specifications can and do vary in different applications and actual performance may vary over time. All operating parameters, including "Typicals" must be validated for each customer application by customer's technical experts. SCILLC does not convey any license under its patent rights nor the rights of others. SCILLC products are not designed, intended, or authorized for use as components in systems intended for surgical implant into the body, or other applications intended to support or sustain life, or for any other application in which the failure of the SCILLC product could create a situation where personal injury or death may occur. Should Buyer purchase or use SCILLC products for any such unintended or unauthorized application, Buyer shall indemnify and hold SCILLC and its officers, employees, subsidiaries, affiliates, and distributors harmless against all claims, costs, damages, and expenses, and reasonable attorney fees arising out of, directly or indirectly, any claim of personal injury or death associated with such unintended or unauthorized use, even if such claim alleges that SCILLC was negligent regarding the design or manufacture of the part. SCILLC is an Equal Opportunity/Affirmative Action Employer. This literature is subject to all applicable copyright laws and is not for resale in any manner.

### PUBLICATION ORDERING INFORMATION

**LITERATURE FULFILLMENT:**  
Literature Distribution Center for ON Semiconductor  
P.O. Box 5163, Denver, Colorado 80217 USA  
**Phone:** 303-675-2175 or 800-344-3860 Toll Free USA/Canada  
**Fax:** 303-675-2176 or 800-344-3867 Toll Free USA/Canada  
**Email:** orderlit@onsemi.com

**N. American Technical Support:** 800-282-9855 Toll Free USA/Canada  
**Europe, Middle East and Africa Technical Support:**  
Phone: 421 33 790 2910  
**Japan Customer Focus Center**  
Phone: 81-3-5773-3850

**ON Semiconductor Website:** [www.onsemi.com](http://www.onsemi.com)  
**Order Literature:** <http://www.onsemi.com/orderlit>  
For additional information, please contact your local Sales Representative