MSM9800/9836 EVA Board

Voice ROM Evaluation Board for MSM9802/9803/9805/9836

GENERAL DESCRIPTION

The MSM9800/36 Evaluation Board is designed to evaluate sound data, created by using OKI's Sound Analysis and Editing tool (AR762/203/204), for use with MSM9802/MSM9803/MSM9805/MSM9836.

FEATURES

- 512 Kbit/1 Mbit/2 Mbit/4 Mbit EPROM can be used for evaluation.
 - Power Supply: 4.75 to 5.25V
 - Clock Oscillation: 4.096 MHz Ceramic Oscillation
- The board is not functional with CR oscillation. Input to the XT/ $\overline{\text{CR}}$ pin is disabled.

NOTE

Some operations may not be identical to those with an actual target device. Further description is given later in this document after Page 9.

BOARD LAYOUT

Board Layout (Top View)

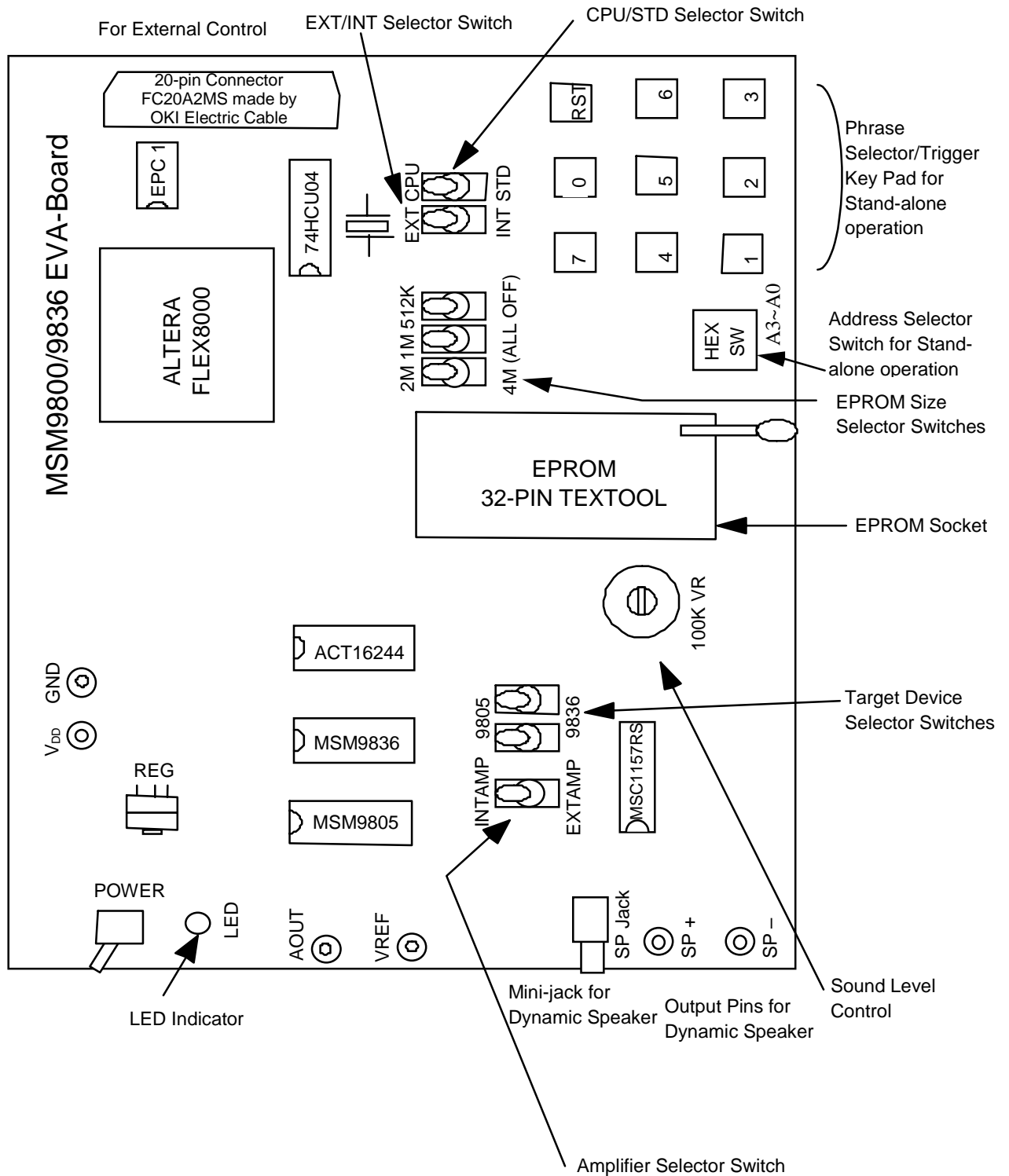

SETTING UP AND OPERATING THE BOARD

Power Supply and Power-On Switch

The following power supply options are available with the board. Be sure to select a right power supply option to your environment before ordering.

- On-board AC 100 V Power Unit
Hook up power cable from the unit to AC 100 V outlet. Push upward the switch on the unit to turn it ON, and push downward to turn it OFF.
- On-board AC 100 V to 240 V Power Unit
Hook up power cable from the unit to AC 100 to 240 V outlet. Push upward the on-board Power switch to turn the board ON, and push downward to turn it OFF.
- On-board Battery Box
Use 4 × AAA batteries. Push upward the on-board Power switch to turn the board ON, and push downward to turn it OFF.
Lower battery voltage may cause noise to be overlapped with voice. In that case, use new batteries.
- External Power Source
Input +5 V to the on-board V_{DD} pin and 0 V to the GND pin.

The board's LED indicator goes on when power is supplied properly to it, whichever power option you choose.

20-pin Connector

The connector provides an interface for an external MCU control.

You can input/output control signals via this 20-pin connector when you use an external MCU to control the board. The following table describes the pin connections.

M9800/9836 Connector Pin Layout

Pin No.	When evaluating MSM9802/03/05 (xxx) represents a physical pin name (Left: STD mode/Right: CPU mode)	When evaluating MSM9836 (xxx) represents a physical pin name
1	V _{CC}	V _{CC}
2	V _{CC}	V _{CC}
3	V _{CC}	V _{CC}
4	EXTCPUSTDB (CPU/ \overline{STD})	EXTCPUSTDB (Not applicable)
5	N.C.	BUSYBOUT (\overline{BUSY})
6	EXTI0 (SW0•I0)	EXTI0 (I0)
7	EXTI1 (SW2•I1)	EXTI1 (I1)
8	EXTI2 (SW3•I2)	EXTI2 (I2)
9	EXTI3 (A0•I3)	EXTI3 (I3)
10	EXTI4 (A1•I4)	EXTI4 (I4)
11	EXTI5 (A2•I5)	EXTI5 (I5)
12	N.C.	EXTI6 (I6)
13	N.C.	N.C.
14	EXTRESTB (\overline{RESET})	EXTRESTB (\overline{RESET})
15	EXTSTB (Not applicable• \overline{ST})	EXTSTB (\overline{ST})
16	N.C.	N.C.
17	NAROUT (\overline{BUSY} •NAR)	NAROUT (NAR)
18	GND	GND
19	GND	GND
20	GND	GND

Note 1: 1-3 pins of this connector output +5 V. Short circuit with power supply circuit of the external unit may cause damage of the power supply unit and/or the evaluation board. (The connector's 1 - 3 pins should be cut and isolated, as required.)

Note 2: Every input pin is either pulled-up or pulled-down with a resistor. Be aware that not every pin function identically to those on your target device, MSM9802/03/05/36.

Evaluation ROM Socket

Use this socket to mount an EPROM containing sound data for evaluation. When using a 512 Kbit EPROM, place the chip so that the pin 14 is inserted to the socket's pin 16 position, as shown in the figure below. Use EPROM Size Selector Switches to select a proper EPROM size.

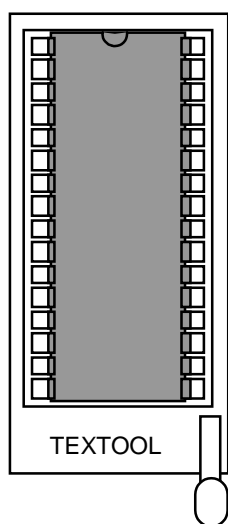

Mounting position for a 4 Mbit, 2 Mbit or 1 Mbit EPROM

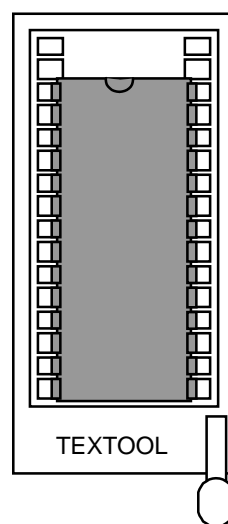

Mounting position for a 512 Kbit EPROM

EPROM Size Selector Switches

The following table shows the selector switch position for each EPROM size.

EPROM Size	2M/4M Selector	1M/4M Selector	512K/4M Selector
4 Mbit	4Mbit Side	4 Mbit Side	4 Mbit Side
2 Mbit	2 Mbit Side	4 Mbit Side	4 Mbit Side
1 Mbit	4 Mbit Side	1 Mbit Side	4 Mbit Side
512 Kbit	4 Mbit Side	4 Mbit Side	512 Kbit Side

* Use an EPROM of equal or larger size than the target device's on-chip ROM.

Control Selector Switches

Target Device Selector Switches

M9805 side: To evaluate sound data for use with MSM9802/03/05.

M9836 side: To evaluate sound data for use with MSM9836.

EXT/INT Selector Switch

EXT side: To control MCU IF/Stand-alone mode switching and phrase triggering from an external MCU via 20-pin connector.

INT side: To control MCU IF/Stand-alone mode switching and phrase triggering by using on-board CPU/STD Selector and Phrase Selector/Trigger Key Pad.

CPU/STD Selector Switch:

To select either CPU (MCU IF) mode or Stand-alone mode.

CPU side: The board operates in MCU IF mode.

STD side: The board operates in Stand-alone mode.

This switch is functional only when the EXT/INT switch is set to the INT side. (When being set to the EXT side, you can control this function via No. 4 pin of 20-pin connector.)

Amplifier Selector Switch**INTAMP/EXTAMP Selector Switch:**

To select either INTAMP (on-board amplifier) or EXTAMP (external amplifier)

INTAMP: Enables to use on-board amplifier (MSC1157) to drive a speaker. Use the on-board volume control to adjust sound level.

EXTAMP: Enables to use an external amplifier to drive a speaker. You can adjust sound level with variable voltage input to the on-board VREF check pin. When the VREF pin is left open, output is at the maximum level because of a pull-down resistor built in the physical device.

Address Selector Switch and Phrase Selector/Trigger Key Pad for Stand-alone Operation**Address Selector Switch for Stand-alone Operation:**

- For MSM9802/03/05
0h to 7h selected with this switch are equivalent to binary data input to the A2 to A0 pins when a target device is used in stand-alone mode.
- For MSM9836
0h to 7h selected with this switch are equivalent to binary data input to the I6 to I3 pins.

Phrase Selector/Trigger Key Pad for Stand-alone Operation:

- For MSM9802/03/05
Pushing a 0 to 7 key causes to start a phrase that corresponds to 0 to 7 of SW2 to SW0.
- For MSM9836
Pushing a 0 to 7 key causes to start a phrase that corresponds to 0 to 7 of I2 to I0.

RST Key:

Reset switch

The figure in the next page shows operation flow explaining how to start a phrase both in EXT mode and INT mode.

Sound Level Control

Volume control

Turn right to increase sound level and turn left to decrease the level.

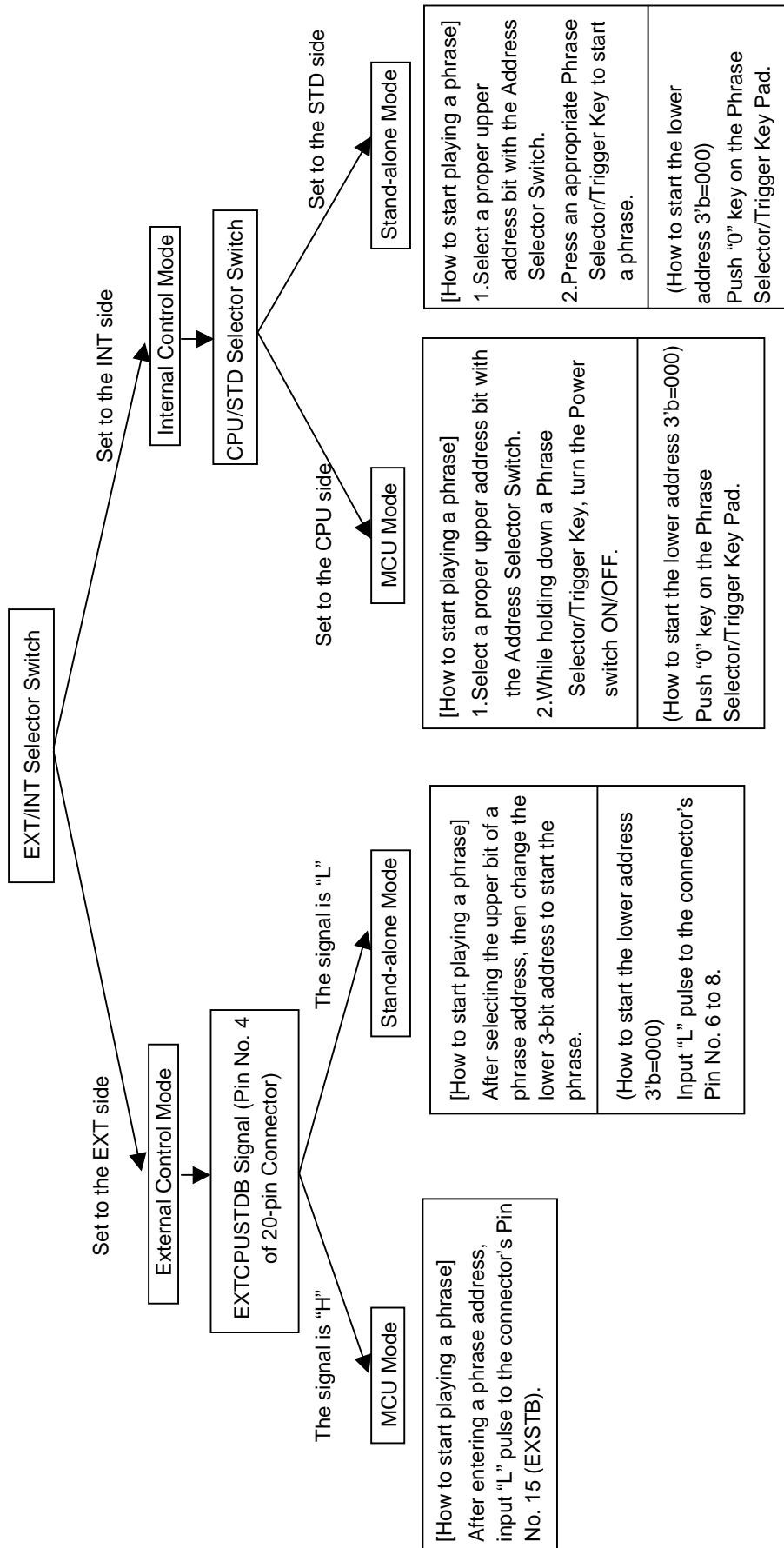

Operation Flow Explaining How To Start a Phrase

OPERATIONAL DIFFERENCES BETWEEN THE BOARD AND TARGET DEVICES (MSM9802/MSM9803/MSM9805/MSM9836)

Operating Ranges (Both in MCU IF mode and Stand-alone mode)

(GND = 0 V)

Parameter	Symbol	Conditions	Range	Unit
Power Supply Voltage	V_{DD}	—	+4.75 to +5.25	V
Operating Temperature	T_{OP}	—	0 to +50	°C
Clock Oscillation	f_{OSC}	Ceramic Oscillation	3.5 to 4.096 (Typ) to 4.5	MHz

DC Characteristics (Both in MCU IF mode and Stand-alone mode)

(Unless otherwise specified: $V_{DD} = 5.0$ V, GND = 0 V, $T_a = 0$ to +50°C)

Parameter	Symbol	Conditions	Min.	Typ.	Max.	Unit
"H" Input Current to Pulled-up Pin	I_{IH1}	$V_{IH} = V_{DD}$	—	—	10	μA
"H" Input Current to Pulled-down Pin	I_{IH2}	$V_{IH} = V_{DD}$	25	50	75	μA
"L" Input Current to Pulled-up Pin	I_{IL1}	$V_{IL} = GND$	-10	—	—	μA
"L" Input Current to Pulled-down Pin	I_{IL2}	$V_{IL} = GND$	-75	-50	-25	μA
Power Consumption	I_{DD}	—	Unavailable			mA
Standby Power Consumption	I_{DDS}	—	Unavailable			μA

Functions

The following list describes the board's functional differences from those on MSM9802/9803/9805. Use MSM98P05 to evaluate such functions as listed.

Functional Comparison List of M98xx/M9836 Old/New Evaluation Board

Type		M98xx Device	M9836 Device	(For reference only) M98P05 Device	New Eva. Board (With M98xx/M9836)	
					INT Mode	EXT Mode
Mode						
Stand-alone	Repeat Play (When holding down a Trigger key)	○		○	× (Single Phrase Only)	× (Single Phrase Only)
	Random Function	○		○	×	×
	When the next phrase triggered halfway of playback	○		○	○	○
MCU/IF	Contiguous Play (A function that enables the 2nd phrase to start after the 1st phrase ends.)	○	○	○	○	○

○ : Available
 × : Not Available

Status Signal

The following list describes status signal output of the board.

M98xx/M9836 Eva. Board Status Signal List

Type	New Eva. Board (With M98xx/M9836)			
	INT Mode		EXT Mode	
Interface	Stand-alone	MCU/IF	Stand-alone	MCU/IF
$\overline{\text{BUSY}}$ (Connector No. 5 Pin)	○	○	○	○
NAR (Connector No. 17 Pin)	M98xx outputs $\overline{\text{BUSY}}$ signal M9836 outputs NAR signal	Outputs NAR	M98xx outputs $\overline{\text{BUSY}}$ signal M9836 outputs NAR signal	Outputs NAR

○ :Available

CIRCUIT DIAGRAM

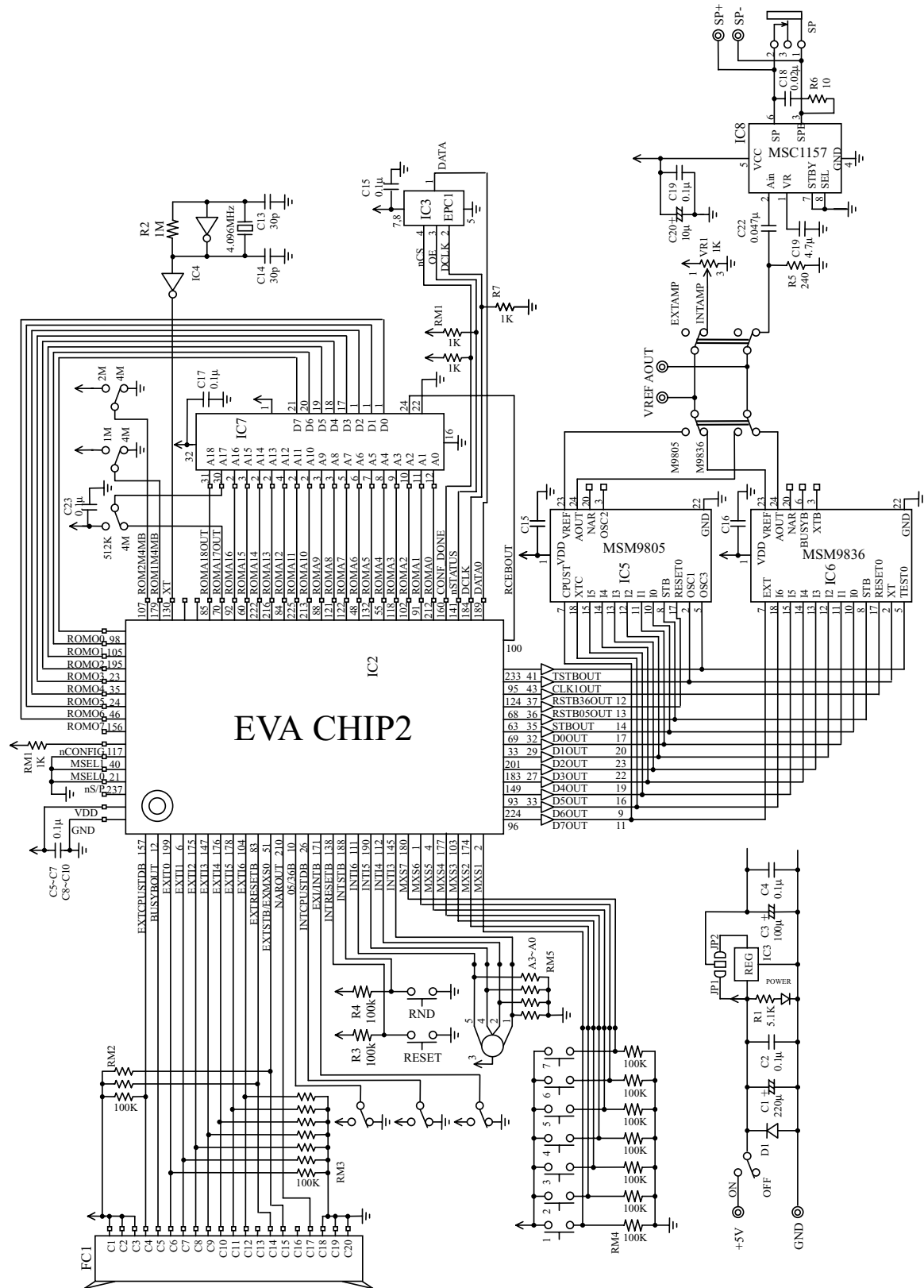

BOARD PCB AND LAYOUT

Silk-printed Side

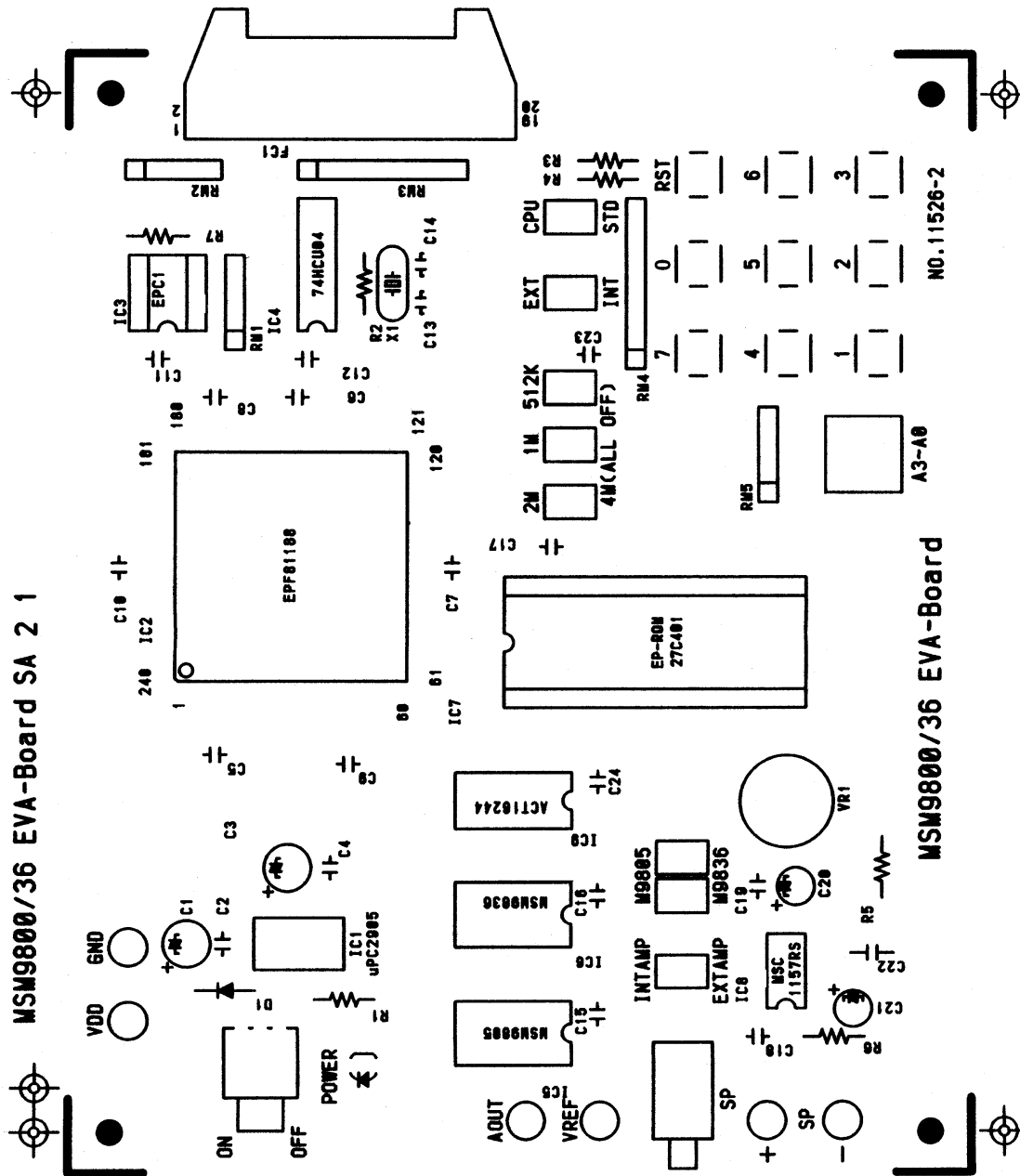

Parts Side

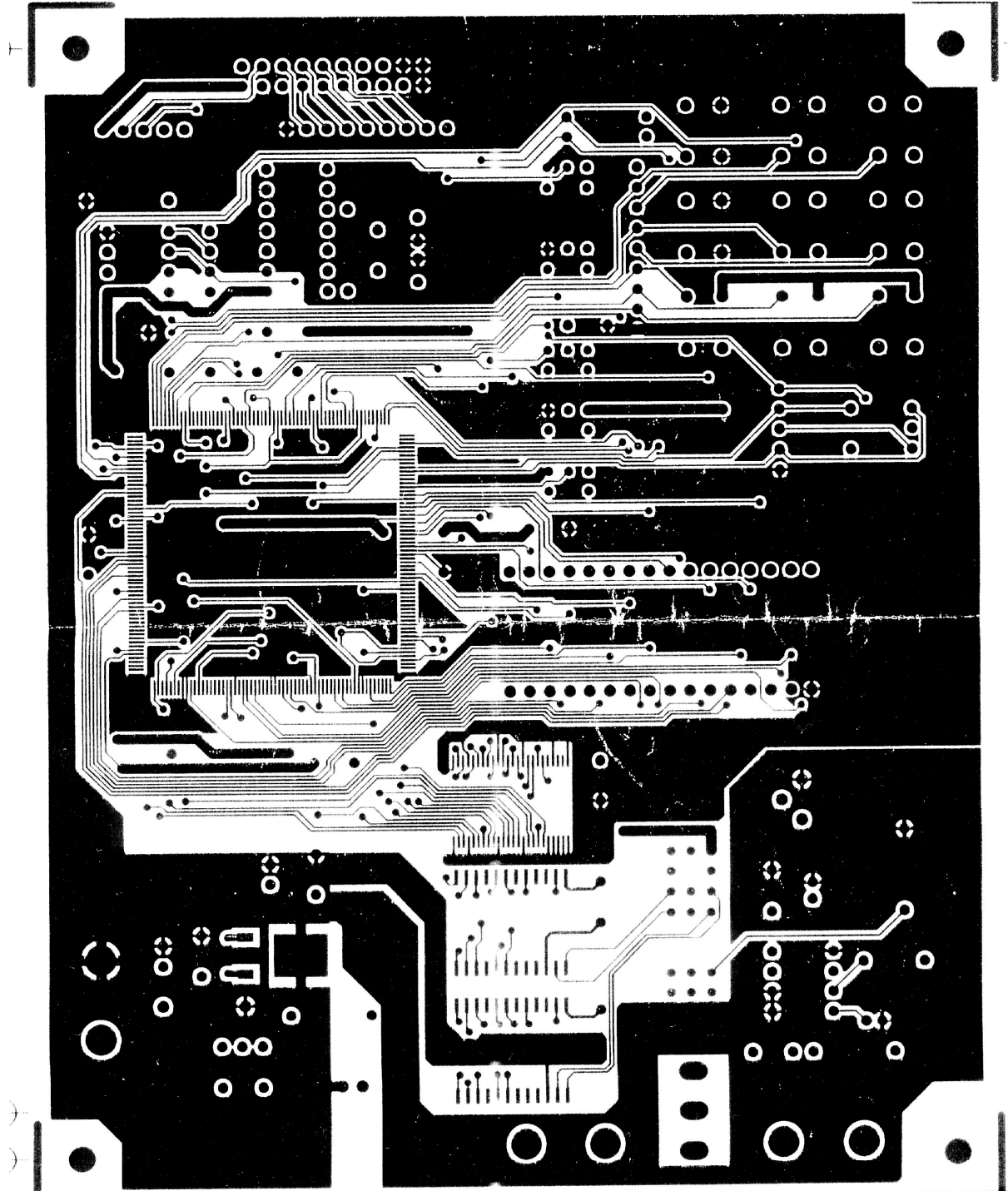

Soldering Side

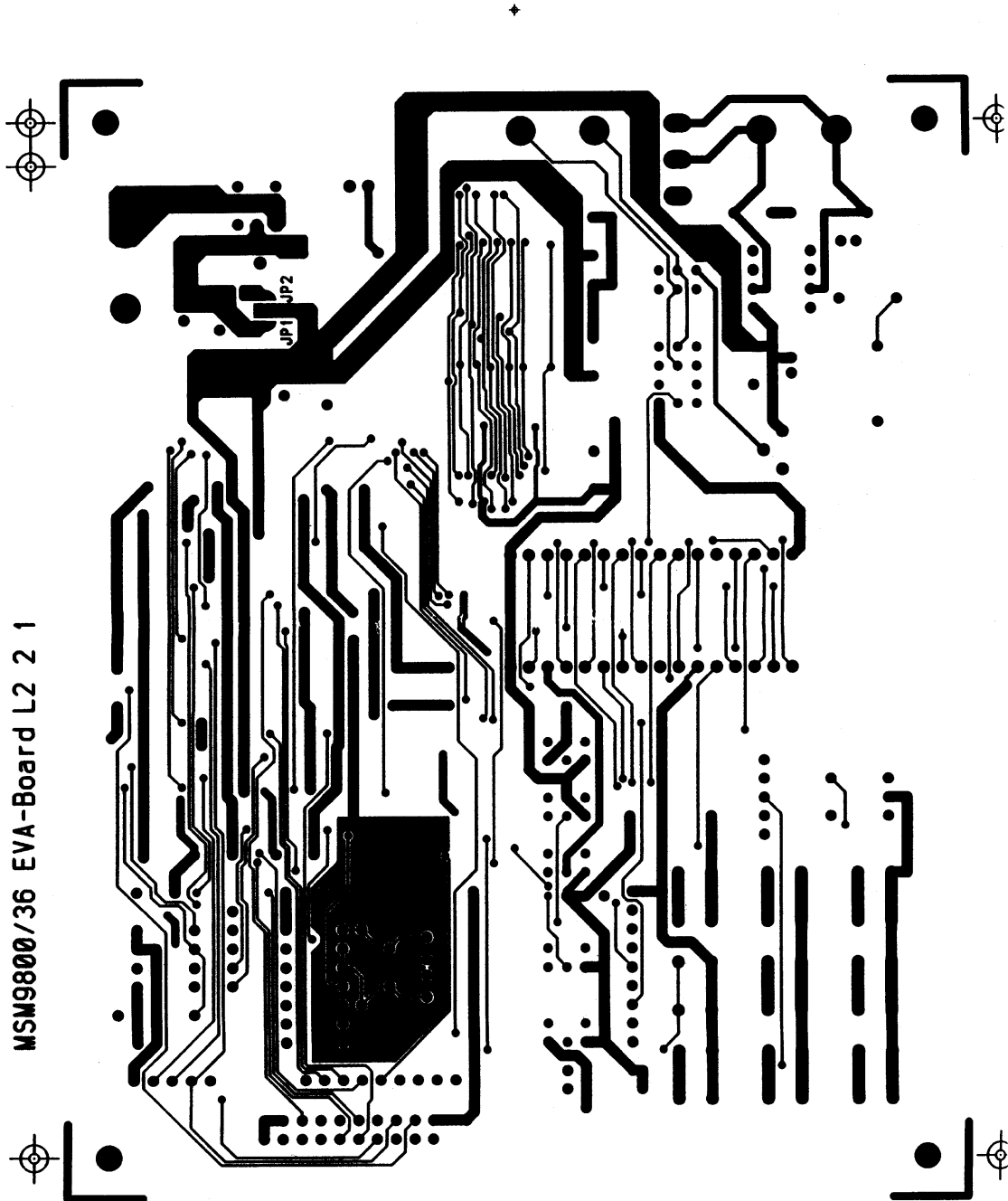

NOTICE

1. The information contained herein can change without notice owing to product and/or technical improvements. Before using the product, please make sure that the information being referred to is up-to-date.
2. The outline of action and examples for application circuits described herein have been chosen as an explanation for the standard action and performance of the product. When planning to use the product, please ensure that the external conditions are reflected in the actual circuit, assembly, and program designs.
3. When designing your product, please use our product below the specified maximum ratings and within the specified operating ranges including, but not limited to, operating voltage, power dissipation, and operating temperature.
4. Oki assumes no responsibility or liability whatsoever for any failure or unusual or unexpected operation resulting from misuse, neglect, improper installation, repair, alteration or accident, improper handling, or unusual physical or electrical stress including, but not limited to, exposure to parameters beyond the specified maximum ratings or operation outside the specified operating range.
5. Neither indemnity against nor license of a third party's industrial and intellectual property right, etc. is granted by us in connection with the use of the product and/or the information and drawings contained herein. No responsibility is assumed by us for any infringement of a third party's right which may result from the use thereof.
6. The products listed in this document are intended for use in general electronics equipment for commercial applications (e.g., office automation, communication equipment, measurement equipment, consumer electronics, etc.). These products are not authorized for use in any system or application that requires special or enhanced quality and reliability characteristics nor in any system or application where the failure of such system or application may result in the loss or damage of property, or death or injury to humans. Such applications include, but are not limited to, traffic and automotive equipment, safety devices, aerospace equipment, nuclear power control, medical equipment, and life-support systems.
7. Certain products in this document may need government approval before they can be exported to particular countries. The purchaser assumes the responsibility of determining the legality of export of these products and will take appropriate and necessary steps at their own expense for these.
8. No part of the contents contained herein may be reprinted or reproduced without our prior permission.

Copyright 2002 Oki Electric Industry Co., Ltd.