

**MSK**

M.S.KENNEDY CORP.

**20W  
DC-DC  
CONVERTERS****BBF2800S  
SERIES**

4707 Dey Road Liverpool, N.Y. 13088

(315) 701-6751

**FEATURES:**

- All Ceramic Capacitors
- Surface Mount Magnetics
- MIL STD 461C CR03 (DC-DC Converters)
- 80 Volt Input Transient Tolerant
- Wide Supply Range - 16V to 50V
- High Isolation - 500V
- High Power Density - 17W/in<sup>3</sup>
- Output Voltage Adjustment - Standard
- Remote Shutdown
- Operates to 14V Input at 10W
- Available with 3.3V, 5V, 12V and 15V Outputs
- Contact MSK for MIL-PRF-38534 Qualification Status

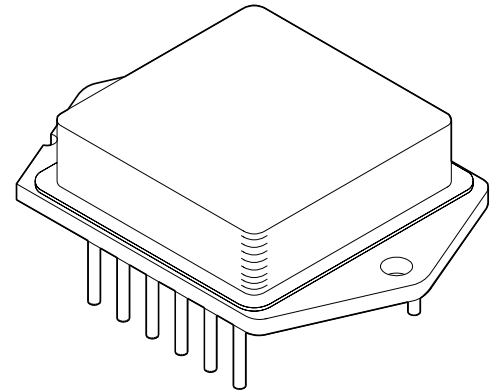
**DESCRIPTION:**

The BBF2800S series of DC-DC converters provides the ruggedness, reliability and features required to meet the advanced design challenges of today's hi-rel market. This has been accomplished using a package having very low thermal gradients, excellent hermeticity and high voltage isolation. The use of advanced substrate and reflow soldering techniques during construction results in a rugged, cost-effective pin solderable package.

The BBF2800S hybrid converter series utilizes all ceramic capacitors and surface mount magnetics to provide reliable operation at all operating temperatures while surviving very high G forces.

BBF2800S series standard features include kelvin sense, indefinite short circuit protection, remote shutdown, output fault monitoring, turn on voltage point adjustment, switching frequency synchronization of up to 3 units using no external components and pi-network input filtering. An output voltage adjustment/load compensation pin is also standard.

Fault tolerance design protects these converters from most external circuit faults. The output and output adjust pins will withstand +35V while the shutdown and all synchronization pins will withstand +50V protecting the converters from a variety of system or board faults, i.e. solder bridges, etc. Unique load fault protection circuitry allows this converter to pull up loads having difficult static load line characteristics and allows short term load excursions significantly beyond ratings in most applications.

The BBF2800 series is a current mode push-pull topology converter which operates at a switching frequency of 500KHz. Internal filtering of both input and output eliminates the need for external capacitors in many applications.

The 12-pin power dip package allows connection to a heatsink and is hermetically sealed and isolated from the internal circuits.

## EQUIVALENT SCHEMATIC

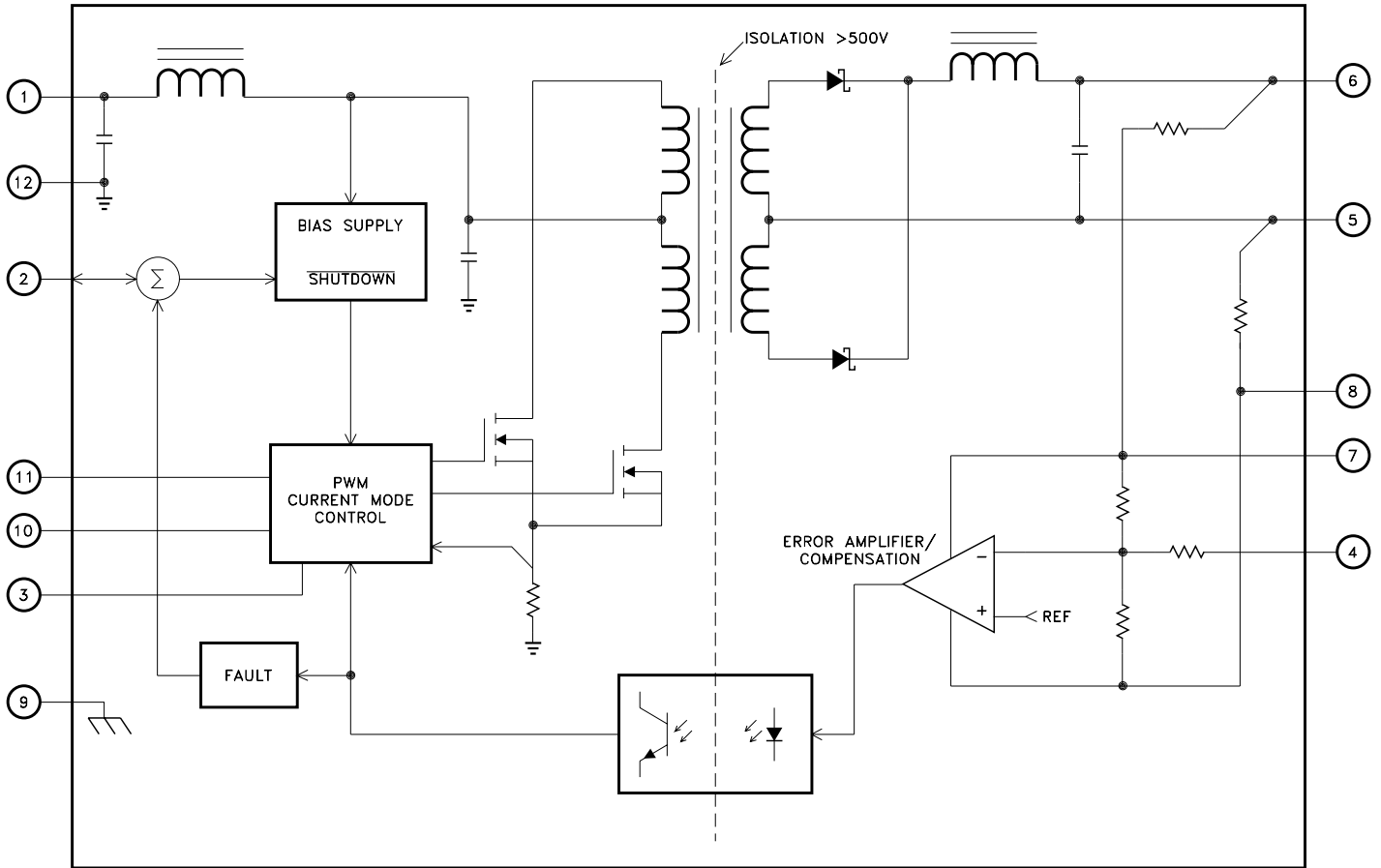

## TYPICAL APPLICATIONS

- Isolated Step Down Power Supply
- Microprocessor Power Source
- Low Voltage Subsystem Power Source

## PIN-OUT INFORMATION

1 + Input	12 -Input
2 Shutdown Plus	11 Timing 2
3 Clock	10 Timing 1
4 Adjust/Comp	9 Case
5 -Output	8 -Sense
6 + Output	7 +Sense

## ABSOLUTE MAXIMUM RATINGS

$V_{IN}$	Input Voltage (pin 7 to pin 6)	+50V
$V_{INT}$	Input Transient (pin 7 to pin 6 @ 50mS)	80V
$I_{OUT}$	Output Current ①	
	BBF2803S	5.5A
	BBF2805S	4.0A
	BBF2812S	1.9A
	BBF2815S	1.5A
$T_C$	Case Temperature Range	
	BBF2800S H/E	-55°C to +125°C
	BBF2800S	-40°C to +85°C

$T_{ST}$	Storage Temperature Range	-65°C to +150°C
$T_{LD}$	Lead Temperature Range	
	(10 Seconds)	300°C
$P_D$	Power Dissipation	See Efficiency Curve
$T_J$	Junction Temperature	150°C
$\theta_{JC}$	Thermal Resistance	
	(Switches)	6.5°C/W

### NOTES:

- ① Continuous operation above the absolute maximum ratings may adversely effect the device performance and/or life cycle.

# ELECTRICAL SPECIFICATIONS

## BBF2803S

Parameter	Test Conditions ①	Group A Subgroup	BBF2803S H/E			BBF2803S			Units
			Min.	Typ.	Max.	Min.	Typ.	Max.	
Output Voltage		1	3.20	3.30	3.40	3.18	3.30	3.42	VDC
		2,3	3.15	-	3.45	-	-	-	VDC
Output Current ② ⑧	16V ≤ VIN ≤ 40V	1	500	-	5500	500	-	5500	mA
		2,3	500	-	5500	-	-	-	mA
Output Voltage Ripple	BW = 10KHz to 2MHz	1	-	20	50	-	20	60	mVrms
		2,3	-	-	60	-	-	-	mVrms
Input Current Ripple ②	BW = 10KHz to 2MHz	1	-	20	50	-	20	60	mArms
		2,3	-	-	60	-	-	-	mArms
Line Regulation	VIN = 16V to 40V	1	-	±2	±20	-	±2	±25	mV
		2,3	-	-	±50	-	-	-	mV
Load Regulation	IOUT = 0.5A to 5.5A	1	-	±1	±15	-	±1	±20	mV
		2,3	-	-	±40	-	-	-	mV
Efficiency		1	61	66	-	61	66	-	%
		2,3	58	-	-	-	-	-	%
Step Load Response ②	IOUT = 2.75A to/from 5.50A Transition Time = 30μS	4	-	±400	±600	-	±400	±700	mV
		5,6	-	-	±800	-	-	-	mV
Step Load Recovery ②	IOUT = 2.75A to/from 5.50A Transition Time = 30μS	4	-	100	200	-	100	220	μS
		5,6	-	-	300	-	-	-	μS
Step Line Response ②	VIN = 16V to/from 40V Transition Time = 30μS	4	-	±500	±750	-	±500	±800	mV
		5,6	-	-	±1000	-	-	-	mV
Step Line Recovery ②	VIN = 16V to/from 40V Transition Time = 30μS	4	-	80	200	-	80	220	μS
		5,6	-	-	300	-	-	-	μS
Start Up Overshoot	IOUT = 5.5A	4	-	0	300	-	0	300	mV
		5,6	-	-	500	-	-	-	mV
Start Up Delay ②	IOUT = 5.5A	4	-	30	60	-	30	60	mS
		5,6	-	-	100	-	-	100	mS
Shutdown Delay ②		4	-	120	500	-	120	500	μS
		5,6	-	-	550	-	-	-	μS
Shutdown Recovery ②		-	-	20	60	-	20	60	mS
Input Voltage Range ②	POUT = 18W MAX.	1,2,3	16	-	40	16	-	40	V
Quiescent Current	Enabled, IOUT = 0mA	1	-	35	40	-	35	40	mA
		2,3	-	-	50	-	-	-	mA
	Disabled IOUT = 0mA	1,2,3	-	1.25	2.5	-	1.25	2.5	mA
Capacitive Load ②	No Effect on DC Performance	1,2,3	-	-	300	-	-	300	μF
Isolation	Input to output or any pin to case @ 500V	1	100	-	-	100	-	-	MΩ
Short Circuit Current Limit ⑦		1	5.5	7.8	8.5	5.5	7.8	8.5	A
Switching Frequency		4	475	500	525	475	500	525	KHz
VOUT Adjustment Range	RPOT = 50KΩ	1	±10	-	-	±10	-	-	%

### NOTES:

- ① +VIN = 28V, IOUT = 5.5A, TA = TC = 25°C unless otherwise specified.
- ② Guaranteed by design but not tested. Typical parameters are representative of actual device performance but are for reference only.
- ③ Industrial grade and "E" suffix devices shall be tested to subgroups 1 and 4 unless otherwise specified.
- ④ Military grade devices ("H" suffix) shall be 100% tested to subgroups 1, 2, 3 and 4.
- ⑤ Subgroups 5 and 6 testing available upon request.
- ⑥ Subgroup 1, 4 TA = TC = +25°C  
2, 5 TA = TC = +125°C  
3, 6 TA = TC = -55°C
- ⑦ Device has internal shutdown feature that pulses the output with a low duty cycle during faults.
- ⑧ At case temperatures above 90°C, the BBF2803 requires VIN > 16V to support a 5.5A load. At 125°C, 18V input is required to support 5.5A output; 16V will support 4A output at 125°C.

# ELECTRICAL SPECIFICATIONS

## BBF2805S

Parameter	Test Conditions ①	Group A Subgroup	BBF2805S H/E			BBF2805S			Units
			Min.	Typ.	Max.	Min.	Typ.	Max.	
Output Voltage		1	5.00	5.05	5.10	4.95	5.05	5.15	VDC
		2,3	4.90	-	5.20	-	-	-	VDC
Output Current ②	16V ≤ VIN ≤ 40V	1	400	-	4000	400	-	4000	mA
		2,3	400	-	4000	-	-	-	mA
Output Voltage Ripple	BW = 10KHz to 2MHz	1	-	20	50	-	20	60	mVrms
		2,3	-	-	60	-	-	-	mVrms
Input Current Ripple ②	BW = 10KHz to 2MHz	1	-	20	50	-	20	60	mArms
		2,3	-	-	60	-	-	-	mArms
Line Regulation	VIN = 16V to 40V	1	-	±5	±25	-	±5	±50	mV
		2,3	-	-	±50	-	-	-	mV
Load Regulation	IOUT = 0.4A to 4.0A	1	-	±2	±25	-	±2	±50	mV
		2,3	-	-	±50	-	-	-	mV
Efficiency		1	65	72	-	65	72	-	%
		2,3	61	-	-	-	-	-	%
Step Load Response ②	IOUT = 2A to/from 4A Transition Time = 30μS	4	-	±700	±1000	-	±700	±1200	mV
		5,6	-	-	±1500	-	-	-	mV
Step Load Recovery ②	IOUT = 2A to/from 4A Transition Time = 30μS	4	-	100	200	-	100	220	μS
		5,6	-	-	300	-	-	-	μS
Step Line Response ②	VIN = 16V to/from 40V Transition Time = 30μS	4	-	±500	±800	-	±500	±900	mV
		5,6	-	-	±1100	-	-	-	mV
Step Line Recovery ②	VIN = 16V to/from 40V Transition Time = 30μS	4	-	80	200	-	80	220	μS
		5,6	-	-	300	-	-	-	μS
Start Up Overshoot	IOUT = 4.0A	4	-	0	400	-	0	400	mV
		5,6	-	-	800	-	-	-	mV
Start Up Delay ②	IOUT = 4.0A	4	-	30	60	-	30	60	mS
		5,6	-	-	100	-	-	100	mS
Shutdown Delay ②		4	-	120	500	-	120	500	μS
		5,6	-	-	550	-	-	-	μS
Shutdown Recovery ②		-	-	20	60	-	20	60	mS
Input Voltage Range ②	POUT = 20W MAX.	1,2,3	16	-	40	16	-	40	V
Quiescent Current	Enabled, IOUT = 0mA	1	-	35	40	-	35	40	mA
		2,3	-	-	50	-	-	-	mA
	Disabled IOUT = 0mA	1,2,3	-	1.25	2.5	-	1.25	2.5	mA
Capacitive Load ②	No Effect on DC Performance	1,2,3	-	-	300	-	-	300	μF
Isolation	Input to output or any pin to case @ 500V	1	100	-	-	100	-	-	MΩ
Short Circuit Current Limit ⑦		1	4.0	6.0	7.0	4.0	6.0	7.0	A
Switching Frequency		4	475	500	525	475	500	525	KHz
VOUT Adjustment Range	RPOT = 50KΩ	1	±10	-	-	±10	-	-	%

### NOTES:

- ① +VIN = 28V, IOUT = 4.0A, TA = TC = 25°C unless otherwise specified.
- ② Guaranteed by design but not tested. Typical parameters are representative of actual device performance but are for reference only.
- ③ Industrial grade and "E" suffix devices shall be tested to subgroups 1 and 4 unless otherwise specified.
- ④ Military grade devices ("H" suffix) shall be 100% tested to subgroups 1, 2, 3 and 4.
- ⑤ Subgroups 5 and 6 testing available upon request.
- ⑥ Subgroup 1, 4 TA = TC = +25°C  
2, 5 TA = TC = +125°C  
3, 6 TA = TC = -55°C
- ⑦ Device has internal shutdown feature that pulses the output with a low duty cycle during faults.

# ELECTRICAL SPECIFICATIONS

## BBF2812S

Parameter	Test Conditions ①	Group A Subgroup	BBF2812S H/E			BBF2812S			Units
			Min.	Typ.	Max.	Min.	Typ.	Max.	
Output Voltage		1	12.00	12.05	12.10	11.95	12.05	12.15	VDC
		2,3	11.80	-	12.30	-	-	-	VDC
Output Current ②	16V ≤ VIN ≤ 40V	1	190	-	1900	190	-	1900	mA
		2,3	190	-	1800	-	-	-	mA
Output Voltage Ripple	BW = 10KHz to 2MHz	1	-	25	50	-	25	60	mVrms
		2,3	-	-	60	-	-	-	mVrms
Input Current Ripple ②	BW = 10KHz to 2MHz	1	-	20	40	-	20	40	mArms
		2,3	-	-	50	-	-	-	mArms
Line Regulation	VIN = 16V to 40V	1	-	±5	±50	-	±5	±60	mV
		2,3	-	-	±100	-	-	-	mV
Load Regulation	IOUT = 0.19A to 1.9A	1	-	±5	±50	-	±5	±60	mV
		2,3	-	-	±100	-	-	-	mV
Efficiency		1	67	74	-	67	74	-	%
		2,3	60	-	-	-	-	-	%
Step Load Response ②	IOUT = 0.95A to/from 1.9A Transition Time = 30μS	4	-	±700	±1200	-	±700	±1400	mV
		5,6	-	-	±1600	-	-	-	mV
Step Load Recovery ②	IOUT = 0.95A to/from 1.9A Transition Time = 30μS	4	-	100	200	-	100	220	μS
		5,6	-	-	300	-	-	-	μS
Step Line Response ②	VIN = 16V to/from 40V Transition Time = 30μS	4	-	±300	±500	-	±300	±550	mV
		5,6	-	-	±800	-	-	-	mV
Step Line Recovery ②	VIN = 16V to/from 40V Transition Time = 30μS	4	-	70	200	-	70	220	μS
		5,6	-	-	300	-	-	-	μS
Start Up Overshoot	IOUT = 1.9A	4	-	0	400	-	0	500	mV
		5,6	-	-	800	-	-	-	mV
Start Up Delay ②	IOUT = 1.9A	4	-	20	60	-	20	60	mS
		5,6	-	-	100	-	-	-	mS
Shutdown Delay ②		4	-	120	500	-	120	500	μS
		5,6	-	-	550	-	-	-	μS
Shutdown Recovery ②		-	-	20	60	-	20	60	mS
Input Voltage Range ②	POUT = 22.8W MAX.	1,2,3	16	-	40	16	-	40	V
Quiescent Current	Enabled, IOUT = 0mA	1	-	35	40	-	35	40	mA
		2,3	-	-	50	-	-	-	mA
	Disabled IOUT = 0mA	1,2,3	-	1.25	2.5	-	1.25	2.5	mA
Capacitive Load ②	No Effect on DC Performance	1,2,3	-	-	300	-	-	300	μF
Isolation	Input to output or any pin to case @ 500V	1	100	-	-	100	-	-	MΩ
Short Circuit Current Limit ⑦		1	1.9	2.8	3.4	1.9	2.8	3.4	A
Switching Frequency		4	475	500	525	475	500	525	KHz
VOUT Adjustment Range	RPOT = 50KΩ	1	±10	-	-	±10	-	-	%

### NOTES:

- ① +VIN = 28V, IOUT = 1.9A, TA = TC = 25°C unless otherwise specified.
- ② Guaranteed by design but not tested. Typical parameters are representative of actual device performance but are for reference only.
- ③ Industrial grade and "E" suffix devices shall be tested to subgroups 1 and 4 unless otherwise specified.
- ④ Military grade devices ("H" suffix) shall be 100% tested to subgroups 1, 2, 3 and 4.
- ⑤ Subgroups 5 and 6 testing available upon request.
- ⑥ Subgroup 1, 4 TA = TC = +25°C  
2, 5 TA = TC = +125°C  
3, 6 TA = TC = -55°C
- ⑦ Device has internal shutdown feature that pulses the output with a low duty cycle during faults.

# ELECTRICAL SPECIFICATIONS

## BBF2815S

Parameter	Test Conditions ①	Group A Subgroup	BBF2815S H/E			BBF2815S			Units
			Min.	Typ.	Max.	Min.	Typ.	Max.	
Output Voltage		1	15.00	15.10	15.20	14.95	15.10	15.25	VDC
		2,3	14.80	-	15.40	-	-	-	VDC
Output Current ②	16V ≤ VIN ≤ 40V	1	150	-	1500	150	-	1500	mA
		2,3	150	-	1400	-	-	-	mA
Output Voltage Ripple	BW = 10KHz to 2MHz	1	-	25	50	-	25	60	mVrms
		2,3	-	-	60	-	-	-	mVrms
Input Current Ripple ②	BW = 10KHz to 2MHz	1	-	20	40	-	20	40	mArms
		2,3	-	-	50	-	-	-	mArms
Line Regulation	VIN = 16V to 40V	1	-	±10	±50	-	±10	±60	mV
		2,3	-	-	±125	-	-	-	mV
Load Regulation	IOUT = 0.15A to 1.5A	1	-	±20	±50	-	±20	±60	mV
		2,3	-	-	±125	-	-	-	mV
Efficiency		1	68	73	-	68	73	-	%
		2,3	66	-	-	-	-	-	%
Step Load Response ②	IOUT = 0.75A to/from 1.50A Transition Time = 30μS	4	-	±800	±1200	-	±800	±1400	mV
		5,6	-	-	±1700	-	-	-	mV
Step Load Recovery ②	IOUT = 0.75A to/from 1.50A Transition Time = 30μS	4	-	100	200	-	40	220	μS
		5,6	-	-	300	-	-	-	μS
Step Line Response ②	VIN = 16V to/from 40V Transition Time = 30μS	4	-	±300	±500	-	±300	±550	mV
		5,6	-	-	±800	-	-	-	mV
Step Line Recovery ②	VIN = 16V to/from 40V Transition Time = 30μS	4	-	80	200	-	80	220	μS
		5,6	-	-	300	-	-	-	μS
Start Up Overshoot	IOUT = 1.5A	4	-	0	400	-	0	500	mV
		5,6	-	-	800	-	-	-	mV
Start Up Delay ②	IOUT = 1.5A	4	-	20	60	-	20	60	mS
		5,6	-	-	100	-	-	-	mS
Shutdown Delay ②		4	-	120	500	-	120	500	μS
		5,6	-	-	550	-	-	-	μS
Shutdown Recovery ②		-	-	20	60	-	30	60	mS
Input Voltage Range ②	POUT = 22.5W MAX.	1,2,3	16	-	40	16	-	40	V
Quiescent Current	Enabled, IOUT = 0mA	1	-	35	40	-	35	40	mA
		2,3	-	-	50	-	-	-	mA
	Disabled IOUT = 0mA	1,2,3	-	1.25	2.5	-	1.25	2.5	mA
Capacitive Load ②	No Effect on DC Performance	1,2,3	-	-	300	-	-	300	μF
Isolation	Input to output or any pin to case @ 500V	1	100	-	-	100	-	-	MΩ
Short Circuit Current Limit ⑦		1	1.5	2.4	3.0	1.5	2.4	3.0	A
Switching Frequency		4	475	500	525	475	500	525	KHz
VOOUT Adjustment Range	RPOT = 50KΩ	1	±10	-	-	±10	-	-	%

### NOTES:

- ① +VIN = 28V, IOUT = 1.5A, TA = TC = 25°C unless otherwise specified.
- ② Guaranteed by design but not tested. Typical parameters are representative of actual device performance but are for reference only.
- ③ Industrial grade and "E" suffix devices shall be tested to subgroups 1 and 4 unless otherwise specified.
- ④ Military grade devices ("H" suffix) shall be 100% tested to subgroups 1, 2, 3 and 4.
- ⑤ Subgroups 5 and 6 testing available upon request.
- ⑥ Subgroup 1, 4 TA = TC = +25°C  
2, 5 TA = TC = +125°C  
3, 6 TA = TC = -55°C
- ⑦ Device has internal shutdown feature that pulses the output with a low duty cycle during faults.

## APPLICATION NOTES

### POWER SUPPLIES

The output voltage of the BBF2800S may be adjusted from 90% to 110% of nominal value by the use of a 50K $\Omega$  potentiometer as shown. Adjustment beyond this range is possible however certain characteristics of the converter such as but not limited to input voltage range, efficiency, ripple and temperature performance will change. Characterization by the user is recommended in such applications.

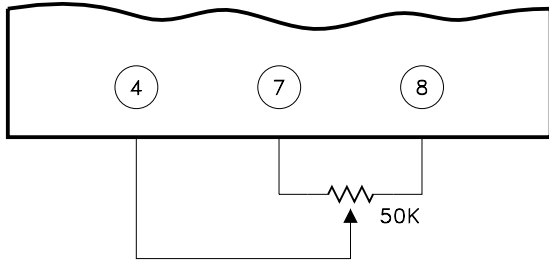

Adjust/comp (pin 4) may be driven by external circuitry referenced to pin 8 (-output sense) if desired. Grounding pin 4 causes output voltage to increase (25% typically) while driving pin 4 above 1.3V causes output voltage to decrease. Pin 4 may be driven through 10K $\Omega$  or more if connection of the comp function is also required.

The comp function of pin 4 allows transient response and phase margin to be tailored to suit a specific application. This feature may be utilized by connecting a small (1-500nF) capacitor between pins 4 and 6 or 7. This is generally recommended when very large low ESR load capacitances are used.

### SHUTDOWN PLUS

Pin 2 is used for remote shutdown, output fault detection, and/or setting the input voltage point at which the converter will turn on as shown in the typical application diagram. No connection to pin 2 is necessary for normal operation of the converter. Pin 2 is referenced to pin 12 (-input).

Shutdown may be implemented by simply connecting pin 2 to an open collector logic output or switch rated at 2.5mA, 25Vdc or higher.

Input voltage turn on point is programmed with a single resistor from pin 2 to 12. An input turn on/off hysteresis (typically 3.5% of  $V_{in}$ ) will be observed. This should be considered when making or verifying set point adjustment. The value of the setpoint resistor may be determined by the following:

$$R = \frac{210 \cdot 10^3}{E_{TO} - 9.5} \quad (\pm 10\% \text{ accuracy at } 25^\circ\text{C})$$

Set point temperature coefficient is typically +400ppm/ $^\circ\text{C}$ . Output fault monitoring is accomplished by observing pin 2 with a high impedance monitoring circuit. Pin 2 voltage drops from over 10V to below 1V when a load fault causes the converters fault protection circuitry to activate. It will remain low for at least 100mS and return high. If the load fault is still present pin 2 will return low and the cycle will repeat. If there is no input setpoint programming resistor already in place a resistor >400K $\Omega$  from pin 2 to 12 will provide pin 2 pull down.

### MULTIPLE CONVERTER SYNCHRONIZATION

Synchronized operation of up to three BBF2800S series converters may be accomplished without external components. One unit selected to be the master is connected normally with pin 10 grounded. The clock output pin 3 will provide the sync signal for up to two slave units. The slave units have pin 10 not connected and receive the clock signal into pin 11. The clock signal lines may be shielded to prevent radiation. A separate 50 ohm coax to each slave unit is recommended in order to preserve signal integrity. Shield ends should be connected to pin 12 of the nearest converter.

BBF2800S converters may also be synchronized to an external 500 KHz (+/- 5%) frequency source driving pin 11 of the converters. Pin 10 is not connected. The converters synchronize to the positive edge of the frequency source allowing a variety of wave forms (pulse, square, spike) to be used. Pin 11 is internally capacitively coupled allowing unipolar or bipolar frequency sources to be used. The source should have a waveform rise time of 20 ns or less and be capable of driving at least 4 volts peak into each 50 ohm pin 11 input (50 volts peak max).

An externally synchronized unit may be used to synchronize other (slave) units. The slave units may be used in turn to synchronize other slave units from their pin 3 outputs. Each "generation" of slave units has a delay (100-200ns typical) from the unit that it is synchronizing to.

# TYPICAL APPLICATION CIRCUIT

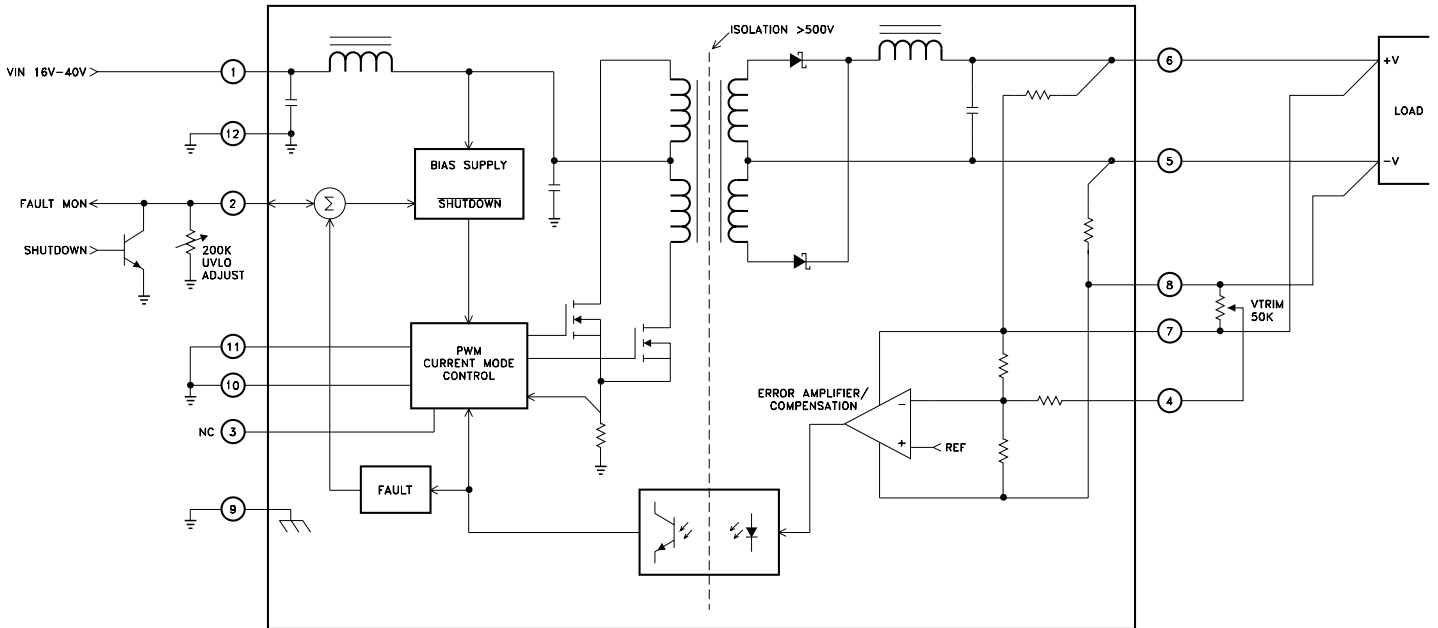

The above diagram shows the remote sense feature which reduces  $V_o$  errors due to the resistance of the conductors feeding the load. This diagram also shows the connections for non-synchronized operation (TIMING 1 and 2) as well as output voltage trim, remote shutdown, fault monitoring, and input voltage turn on point adjustment.



# TYPICAL PERFORMANCE CURVES

BBF2803S

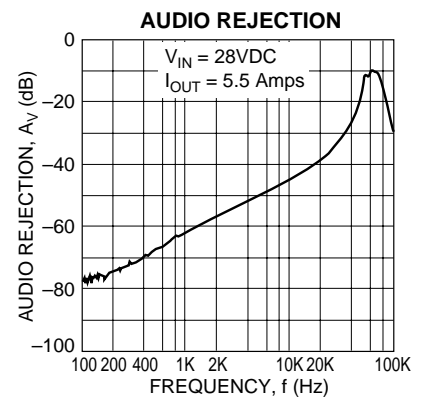
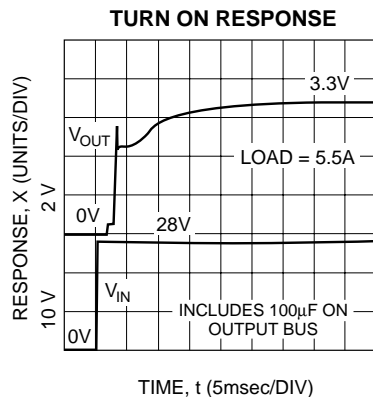
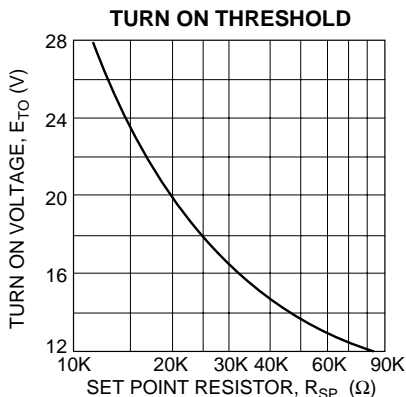
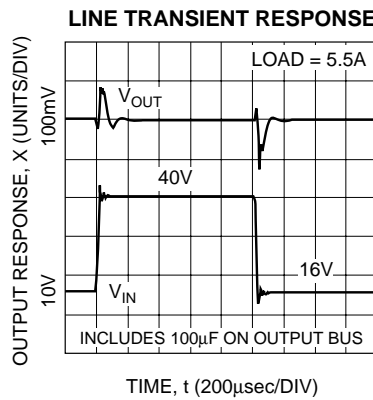
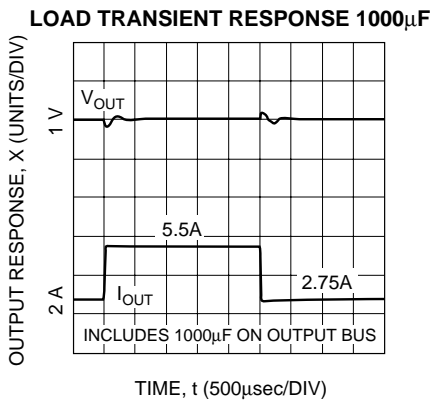
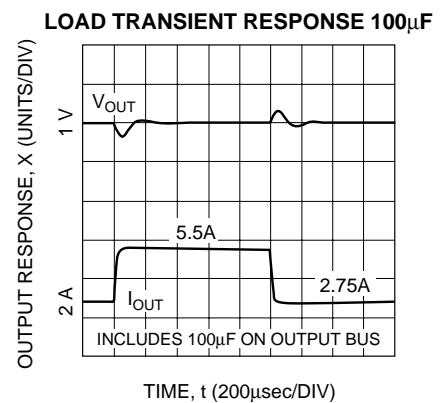
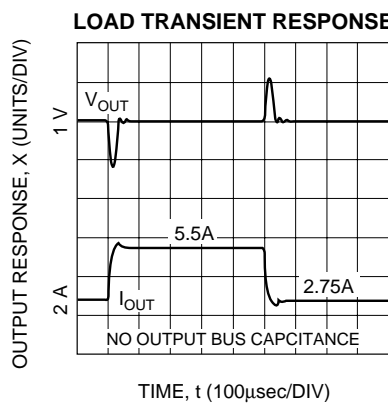
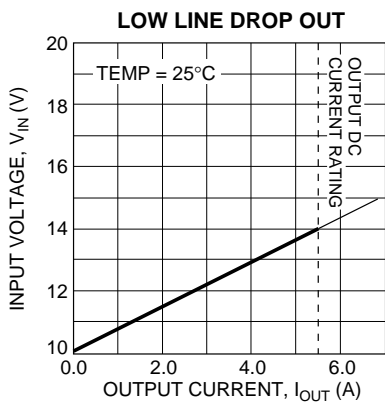
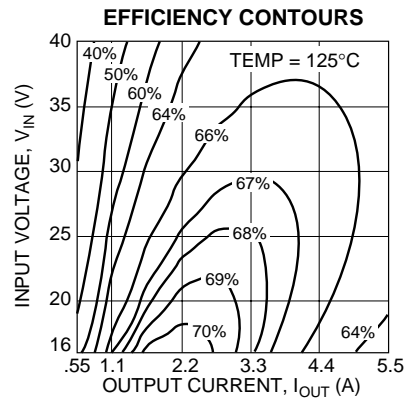
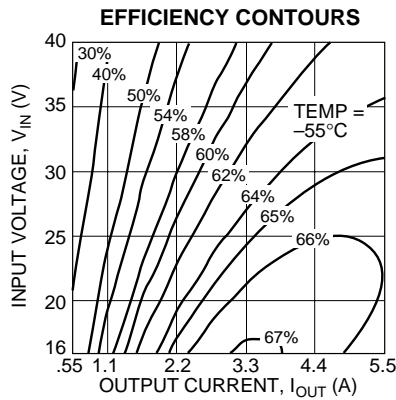
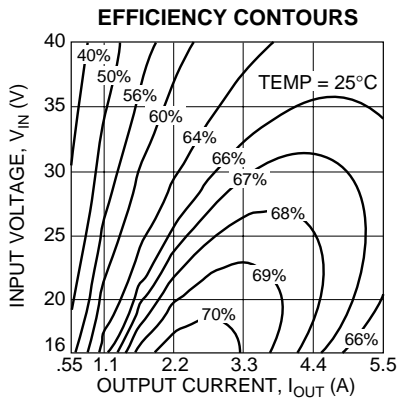

# TYPICAL PERFORMANCE CURVES

BBF2805S

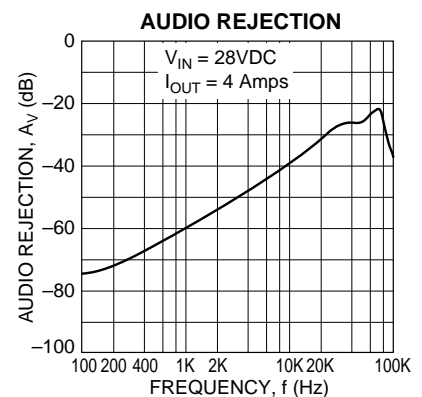
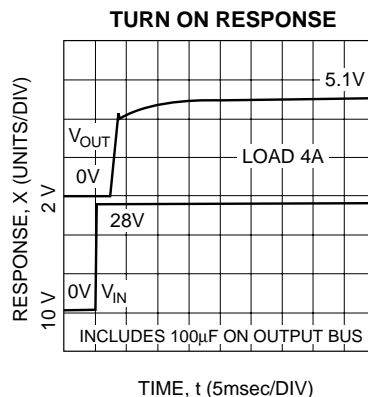
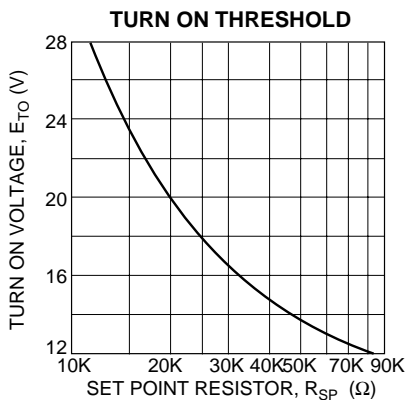
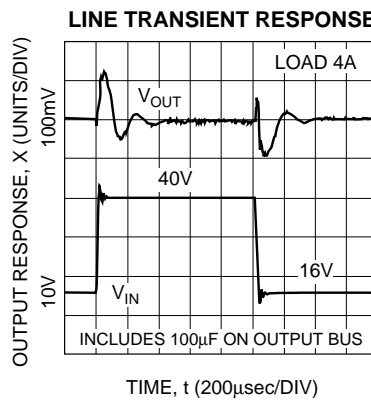
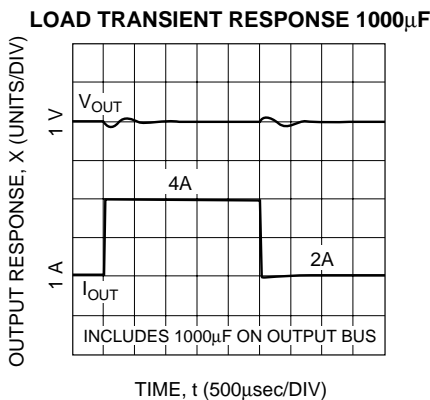
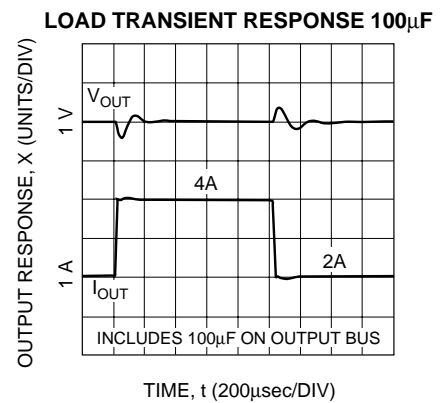
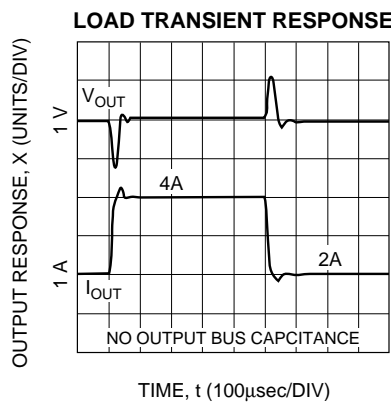
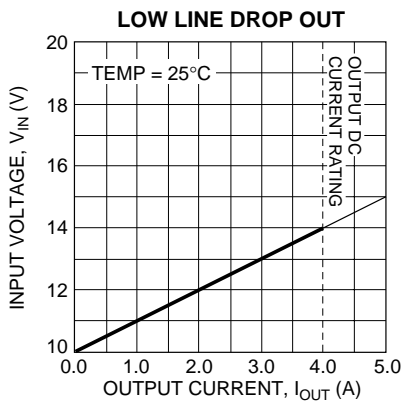
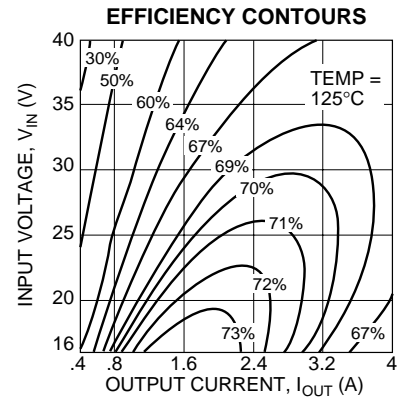
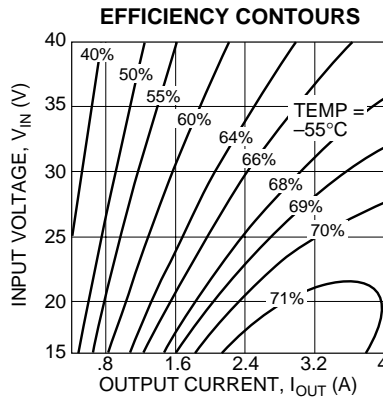
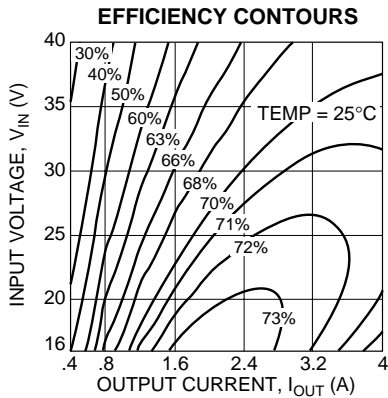

## MECHANICAL SPECIFICATIONS

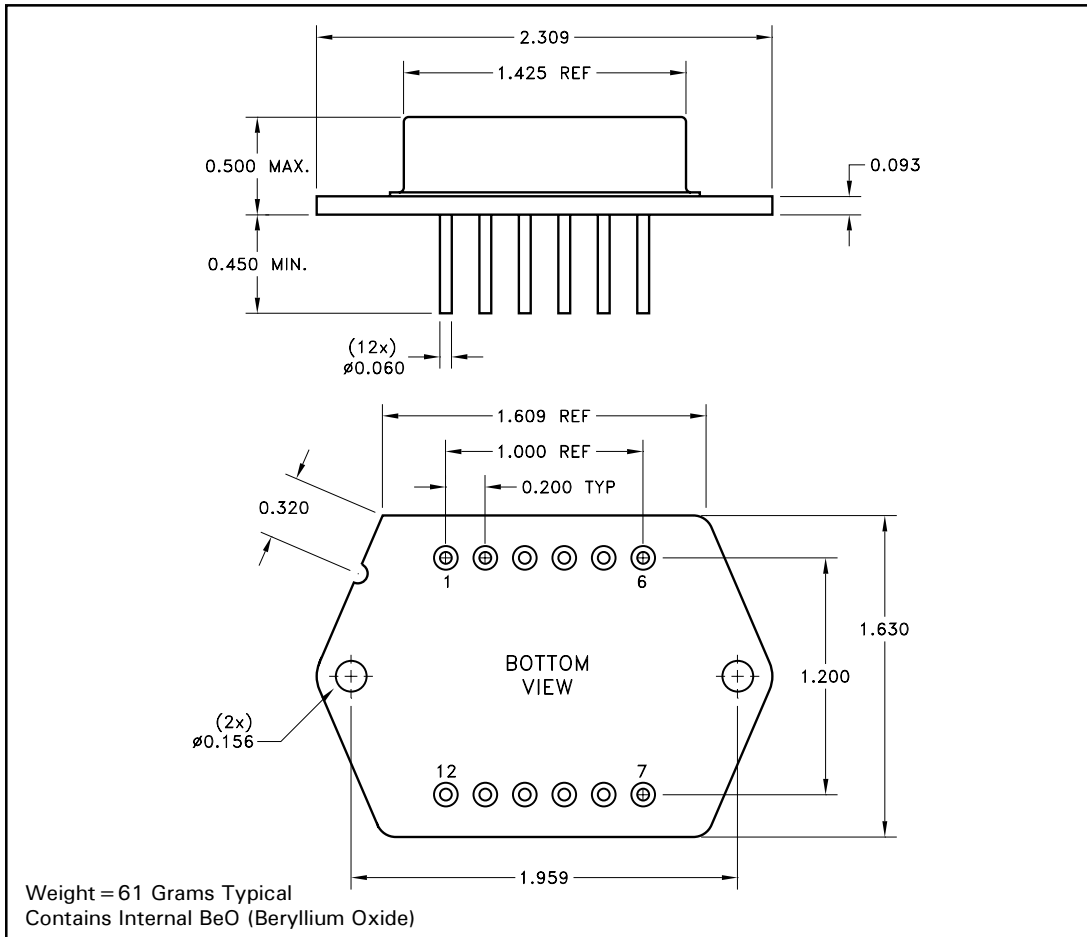

NOTE: ALL DIMENSIONS ARE  $\pm 0.010$  INCHES UNLESS OTHERWISE LABELED.  
ESD Triangle indicates Pin 1.

## ORDERING INFORMATION

**BBF2812S**

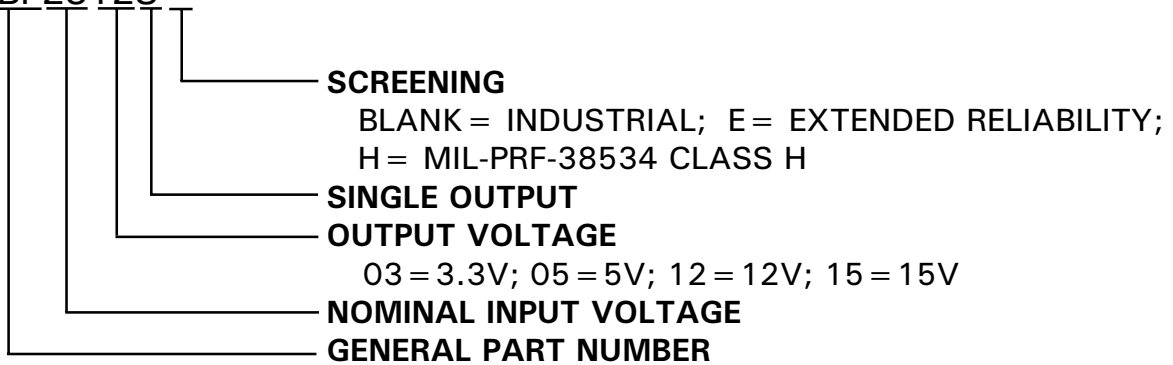

The above example is an industrial grade 12V single output converter

M.S. Kennedy Corp.  
4707 Dey Road, Liverpool, New York 13088  
Phone (315) 701-6751  
FAX (315) 701-6572  
[www.mskennedy.com](http://www.mskennedy.com)

The information contained herein is believed to be accurate at the time of printing. MSK reserves the right to make changes to its products or specifications without notice, however, and assumes no liability for the use of its products. Please visit our website for the most recent revision of this datasheet. Contact MSK for MIL-PRF-38534 qualification status.