

# GCU04AA-130

HIGH POWER INVERTER USE  
PRESS PACK TYPE

GCU04AA-130

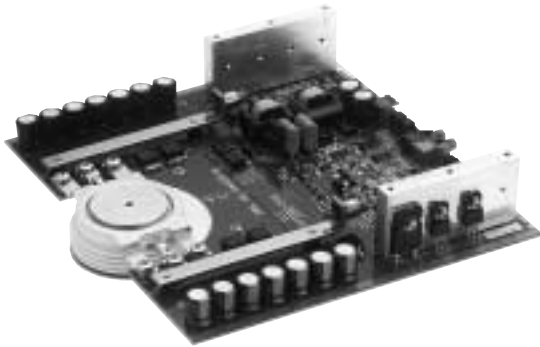

- Symmetrical GCT unit
- GCT and gate driver are connected
- IT(QRM): Repetitive controllable on-state current ..... 400A
- IT(AV): Average on-state current ..... 180A
- VDRM: Repetitive peak off-state voltage ..... 6500V
- VRRM: Repetitive peak reverse voltage ..... 6500V
- T<sub>j</sub>: Operation junction temperature ..... 125°C

## APPLICATION

Current source inverters, DC choppers, Induction heaters, DC to DC converter

## OUTLINE DRAWING

Dimensions in mm

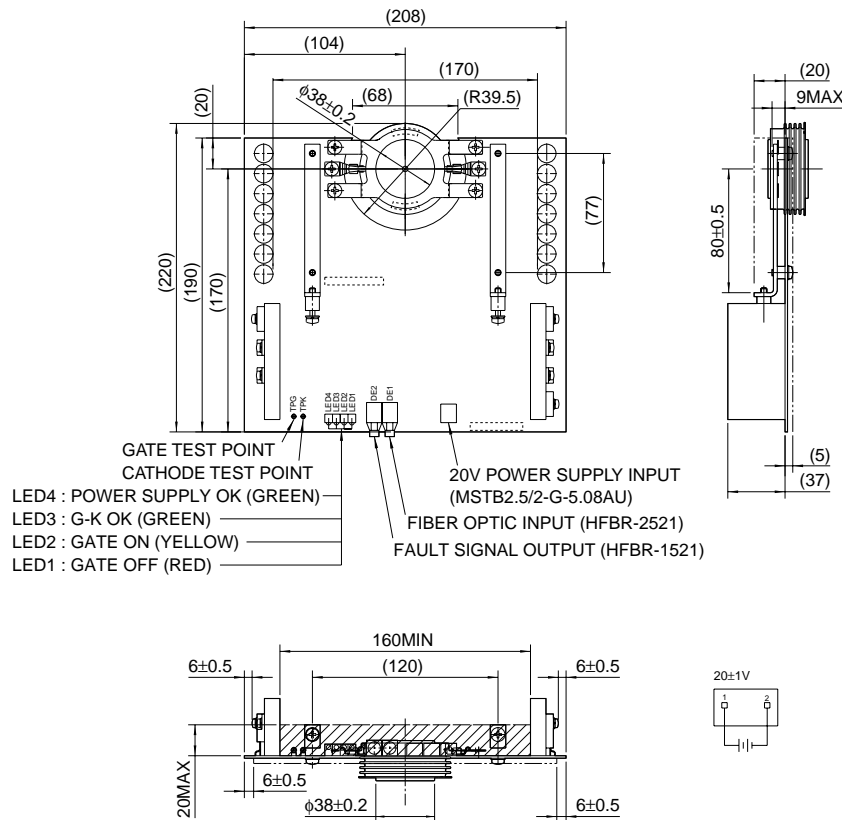

**GCU04AA-130**

HIGH POWER INVERTER USE  
PRESS PACK TYPE

**GCT PART**

**MAXIMUM RATINGS**

Symbol	Parameter	Conditions	Voltage class	Unit
VRRM	Repetitive peak reverse voltage	—	6500	V
VRSM	Non-repetitive peak reverse voltage	—	6500	V
VDRM	Repetitive peak off-state voltage	Gate driver energized	6500	V
VDSM	Non-repetitive peak off-state voltage	Gate driver energized	6500	V
V(LTDS)	Long term DC stability voltage	Gate driver energized, $\lambda = 100$ Fit	3600	V

Symbol	Parameter	Conditions	Ratings	Unit
IT(RMS)	RMS on-state current	Applied for all condition angles	280	A
IT(AV)	Average on-state current	$f = 60\text{Hz}$ , sinewave $\theta = 180^\circ$ , $T_f = 55^\circ\text{C}$	180	A
ITQRM	Repetitive controllable on-state current	$V_{DM} = 4000\text{V}$ , $V_D = 3000\text{V}$ , $L_c = 0.3\mu\text{H}$ $T_j = 25/125^\circ\text{C}$ (See Fig. 1, 3)	400	A
ITSM	Surge on-state current	One half cycle at 60Hz, $T_j = 125^\circ\text{C}$ start	2.8	kA
$I^2t$	Current-squared, time integration		$3.3 \times 10^4$	$\text{A}^2\text{s}$
$di_T/dt$	Critical rate of rise of on-state current	$V_D = 3000\text{V}$ , $I_T = 400\text{A}$ , $C_s = 0.06\mu\text{F}$ , $R_s = 15\Omega$ $T_j = 25/125^\circ\text{C}$ , $f = 60\text{Hz}$ (See Fig. 1, 2)	1000	$\text{A}/\mu\text{s}$
$di_R/dt$	Critical rate of rise of reverse recovery current	$I_T = 400\text{A}$ , $V_R = 3000\text{V}$ , $T_j = 25/125^\circ\text{C}$ $C_s = 0.06\mu\text{F}$ , $R_s = 15\Omega$ (See Fig. 4, 5)	1000	$\text{A}/\mu\text{s}$
PFGM	Peak forward gate power dissipation		3	kW
PRGM	Peak reverse gate power dissipation		9	kW
PFG(AV)	Average forward gate power dissipation		50	W
PRG(AV)	Average reverse gate power dissipation		60	W
VFGM	Peak forward gate voltage		10	V
VRGM	Peak reverse gate voltage		21	V
IFGM	Peak forward gate current		250	A
IRGM	Peak reverse gate current		400	A

**ELECTRICAL CHARACTERISTICS**

Symbol	Parameter	Conditions	Limits			Unit
			Min	Typ	Max	
V <sub>TM</sub>	On-state voltage	$I_T = 400\text{A}$ , $T_j = 125^\circ\text{C}$	—	—	7.5	V
I <sub>RRM</sub>	Repetitive peak reverse current	$V_{RM} = 6500\text{V}$ , $T_j = 125^\circ\text{C}$	—	—	150	mA
I <sub>DRM</sub>	Repetitive peak off-state current	$V_{DM} = 6500\text{V}$ , $T_j = 125^\circ\text{C}$ , Gata driver energized	—	—	100	mA
I <sub>GRM</sub>	Reverse gate current	$V_{RG} = 21\text{V}$ , $T_j = 125^\circ\text{C}$	—	—	50	mA
$dv/dt$	Critical rate of rise of off-state voltage	$V_D = 3000\text{V}$ , $T_j = 125^\circ\text{C}$ Gate driver energized (Expo. wave)	3000	—	—	$\text{V}/\mu\text{s}$
t <sub>gt</sub>	Turn-on time	$I_T = 400\text{A}$ , $V_D = 3000\text{V}$ , $di/dt = 1000\text{A}/\mu\text{s}$ $C_s = 0.06\mu\text{F}$ , $R_s = 15\Omega$ , $T_j = 125^\circ\text{C}$	—	—	5	$\mu\text{s}$
t <sub>d</sub>	Turn-on delay time		—	—	1	$\mu\text{s}$
E <sub>on</sub>	Turn-on switching energy	(See Fig. 1, 2)	—	—	0.7	J/P
t <sub>s</sub>	Storage time	$I_T = 400\text{A}$ , $V_{DM} = 4000\text{V}$ , $V_D = 3000\text{V}$	—	—	3	$\mu\text{s}$
E <sub>off</sub>	Turn-off switching energy	$C_s = 0.06\mu\text{F}$ , $R_s = 15\Omega$ , $T_j = 125^\circ\text{C}$ (See Fig. 1, 5)	—	—	2.9	J/P
Q <sub>RR</sub>	Reverse recovery charge	$V_R = 3000\text{V}$ , $I_T = 400\text{A}$ , $di/dt = 1000\text{A}/\mu\text{s}$	—	—	1600	$\mu\text{C}$
E <sub>rec</sub>	Reverse recovery energy	$C_s = 0.06\mu\text{F}$ , $R_s = 15\Omega$ , $T_j = 125^\circ\text{C}$ (See Fig. 4, 5)	—	—	4.1	J/P
I <sub>GT</sub>	Gate trigger current	$V_D = 24\text{V}$ , $R_L = 0.1\Omega$ , $T_j = 25^\circ\text{C}$	—	—	0.35	A
V <sub>GT</sub>	Gate trigger voltage	DC method	—	—	1.5	V

# GCU04AA-130

HIGH POWER INVERTER USE  
PRESS PACK TYPE

## GATE DRIVER PART

Symbol	Parameter	Conditions	Limits			Unit
			Min	Typ	Max	
V <sub>GIN</sub>	Power supply voltage	DC power supply	19	20	21	V
P <sub>GIN</sub>	Gate power consumption	I <sub>T</sub> = 230Arms, f = 780Hz, duty = 0.33	—	—	20	W
t <sub>fd</sub>	Delay time of on gate current	T <sub>a</sub> = 25°C	—	—	3.0	μs
t <sub>rd</sub>	Delay time of off gate current	T <sub>a</sub> = 25°C	—	—	3.0	μs
—	Control signal	Optical fiber data link Transmitter : HFBR-1521 : Agilent Receiver : HFBR-2521 : Agilent	—	—	—	—
—	Power supply connector	Phoenix contact Type name : MSTB25/2-G-508AU	—	—	—	—
—	Status signal	— (Note 1)	—	—	—	—

## MECHANICAL DATA

Symbol	Parameter	Conditions	Limits			Unit
			Min	Typ	Max	
F <sub>M</sub>	Mounting force	—	7.3	8.6	11	kN
—	Weight	—	—	700	—	g
—	Pole piece diameter (GTC device)	±0.2mm	—	38	—	mm
—	Housing thickness (GTC device)	±0.5mm	—	26	—	mm

## THERMAL DATA

Symbol	Parameter	Conditions	Limits			Unit
			Min	Typ	Max	
T <sub>j</sub>	Junction operating temperature	—	-10	—	125	°C
T <sub>stg</sub>	Storage temperature	—	-10	—	60	°C
T <sub>a</sub>	Ambient operation temperature	Recommend : ≤ 40°C	-10	—	60	°C
R <sub>t(j-f)</sub>	Thermal resistance	Junction to Fin	—	—	0.04	K/W

**GCU04AA-130**

HIGH POWER INVERTER USE  
PRESS PACK TYPE

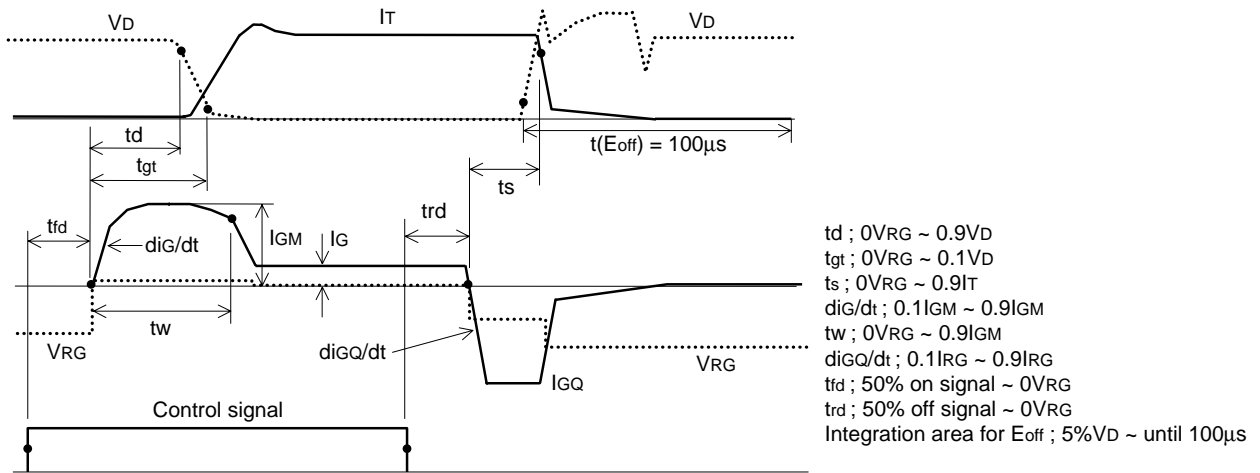

Fig. 1 Turn-on and Turn-off waveform

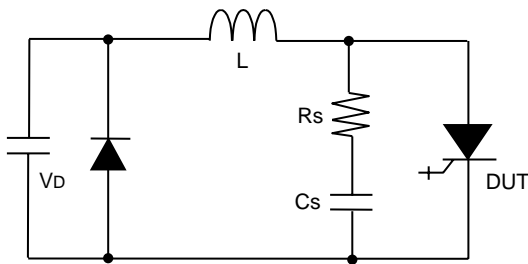

Fig. 2 Turn-on test circuit

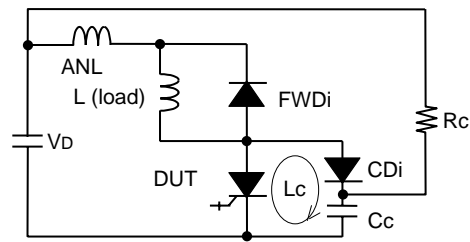

Fig. 3 Turn-off test circuit  
(With clamp circuit)

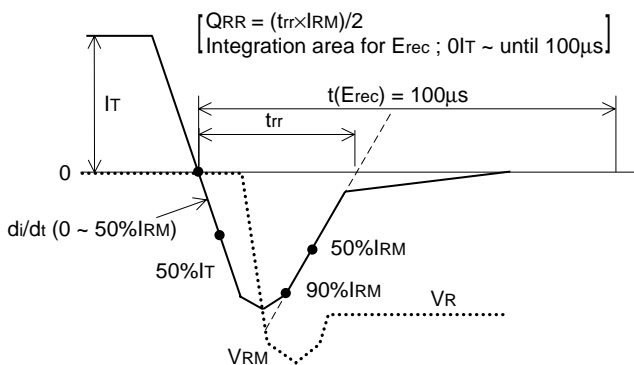

Fig. 4 Reverse recovery waveform

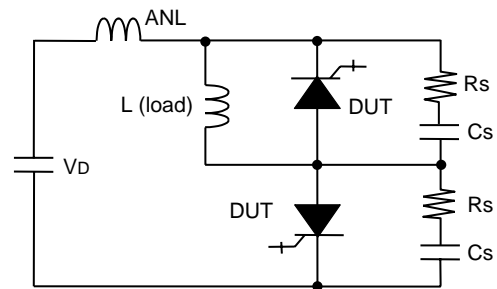

Fig. 5 Turn-off and Reverse recovery test circuit

# GCU04AA-130

HIGH POWER INVERTER USE  
PRESS PACK TYPE

Note 1. Status signal

## 1. Status signal from LED

### (1) Status signal

Status of GCT	LED 1 (Red)	LED 2 (Yellow)
On state	OFF	ON
Off state	ON	OFF

### (2) Fault signal

Status	G-K	Power Supply	G-K LED (LED 3) (Green)	PS LED (LED 4) (Green)
Normal	Normal	20±1V	On	On
Fault	Normal	Voltage down	Off	Off
Fault	G-K short	20±1V	Off	On
Fault	G-K short	Voltage down	Off	Off

## 2. Status signal from Transmitter

(L : Light NL : No light)

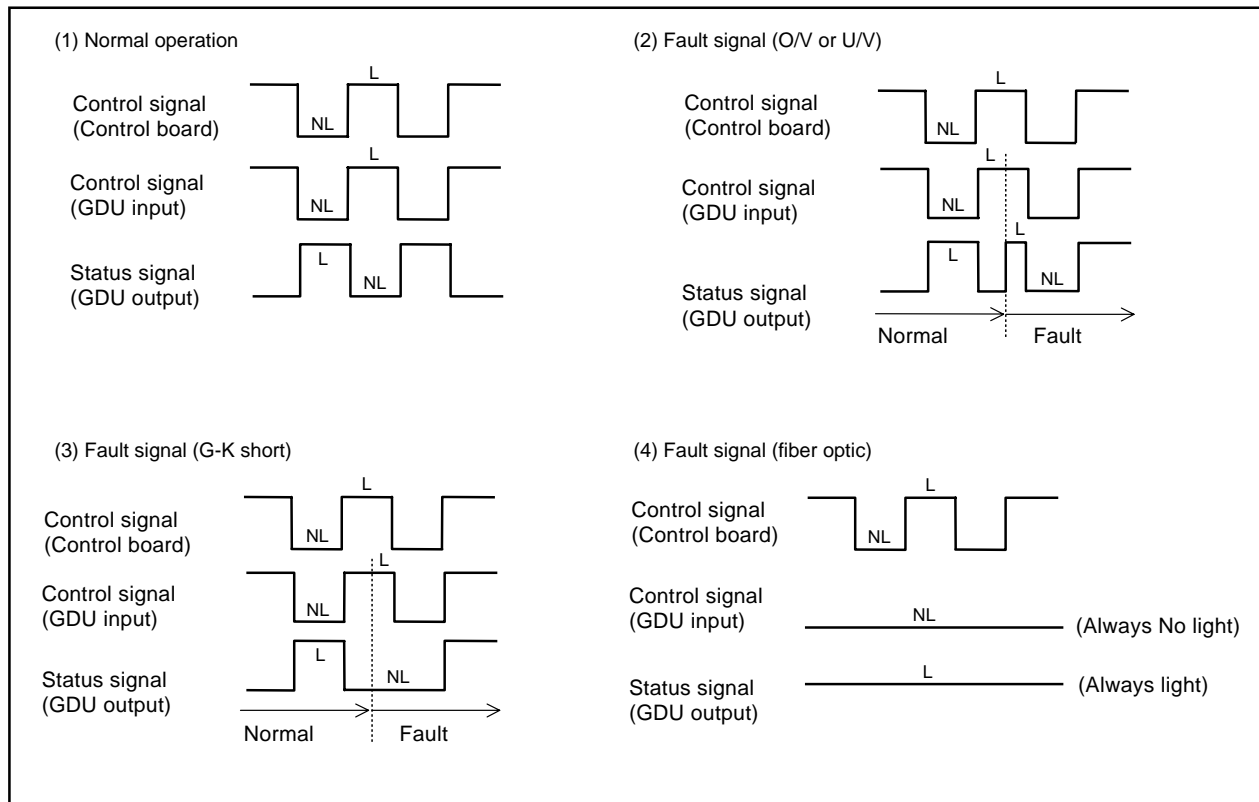

# GCU04AA-130

HIGH POWER INVERTER USE  
PRESS PACK TYPE

## PERFORMANCE CURVES

**MAXIMUM ON-STATE CHARACTERISTIC**

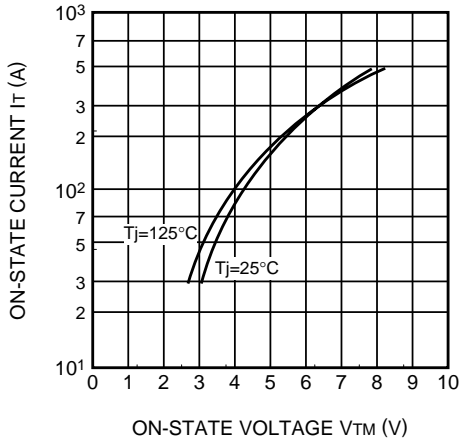

**$E_{on}$  VS  $I_T$  (Max)**

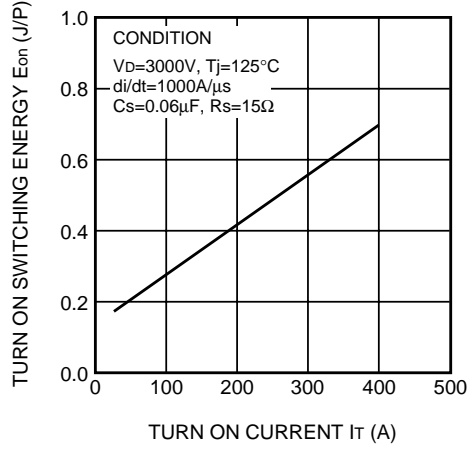

**$E_{off}$  VS  $I_T$  (Max)**

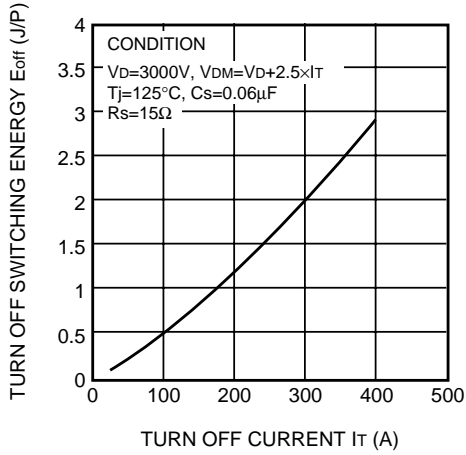

**$E_{rec}$  VS  $I_T$  (Max)**

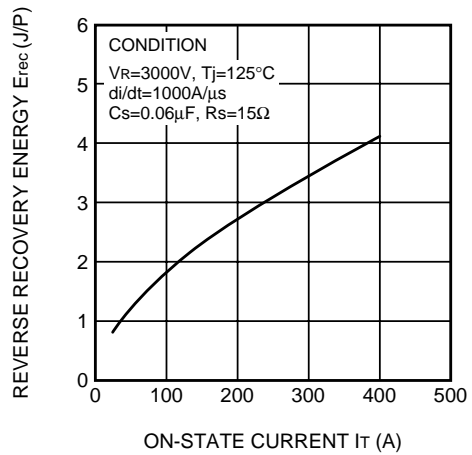

**MAXIMUM THERMAL IMPEDANCE CHARACTERISTIC (JUNCTION TO FIN)**

