

FK10UM-9

HIGH-SPEED SWITCHING USE

FK10UM-9



- V_{DSS} 450V
- $r_{DS(ON)}$ (MAX) 0.92Ω
- I_D 10A
- Integrated Fast Recovery Diode (MAX.) 150ns

OUTLINE DRAWING

Dimensions in mm

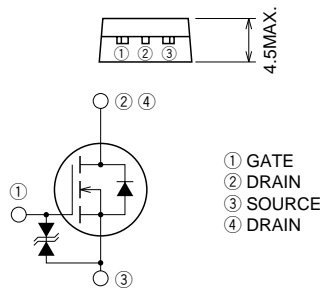
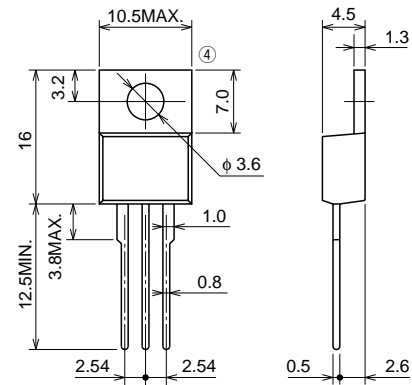

TO-220

APPLICATION

Servo motor drive, Robot, UPS, Inverter Fluorecent lamp, etc.

MAXIMUM RATINGS (Tc = 25°C)

Symbol	Parameter	Conditions	Ratings	Unit
V_{DSS}	Drain-source voltage	$V_{GS} = 0V$	450	V
V_{GSS}	Gate-source voltage	$V_{DS} = 0V$	± 30	V
I_D	Drain current		10	A
I_{DM}	Drain current (Pulsed)		30	A
I_S	Source current		10	A
I_{SM}	Source current (Pulsed)		30	A
P_D	Maximum power dissipation		125	W
T_{ch}	Channel temperature		-55 ~ +150	°C
T_{stg}	Storage temperature		-55 ~ +150	°C
—	Weight	Typical value	2.0	g

ELECTRICAL CHARACTERISTICS (T_{ch} = 25°C)

Symbol	Parameter	Test conditions	Limits			Unit
			Min.	Typ.	Max.	
V (BR) DSS	Drain-source breakdown voltage	I _D = 1mA, V _{GS} = 0V	450	—	—	V
V (BR) GSS	Gate-source breakdown voltage	I _G = ±100μA, V _{DS} = 0V	±30	—	—	V
I _{GSS}	Gate-source leakage current	V _{GS} = ±25V, V _{DS} = 0V	—	—	±10	μA
I _{DSS}	Drain-source leakage current	V _{DS} = 450V, V _{GS} = 0V	—	—	1	mA
V _{GS} (th)	Gate-source threshold voltage	I _D = 1mA, V _{DS} = 10V	2	3	4	V
r _{DS} (ON)	Drain-source on-state resistance	I _D = 5A, V _{GS} = 10V	—	0.70	0.92	Ω
V _{DS} (ON)	Drain-source on-state voltage	I _D = 5A, V _{GS} = 10V	—	3.50	4.60	V
y _{fs}	Forward transfer admittance	I _D = 5A, V _{DS} = 10V	3.3	5.5	—	S
C _{iss}	Input capacitance	V _{DS} = 25V, V _{GS} = 0V, f = 1MHz	—	1100	—	pF
C _{oss}	Output capacitance		—	130	—	pF
C _{rss}	Reverse transfer capacitance		—	20	—	pF
t _d (on)	Turn-on delay time	V _{DD} = 200V, I _D = 5A, V _{GS} = 10V, R _{GEN} = R _{GS} = 50Ω	—	20	—	ns
t _r	Rise time		—	30	—	ns
t _d (off)	Turn-off delay time		—	95	—	ns
t _f	Fall time		—	35	—	ns
V _{SD}	Source-drain voltage	I _S = 5A, V _{GS} = 0V	—	1.5	2.0	V
R _{th} (ch-c)	Thermal resistance	Channel to case	—	—	1.0	°C/W
t _{rr}	Reverse recovery time	I _S = 10A, di _s /dt = -100A/μs	—	—	150	ns

PERFORMANCE CURVES

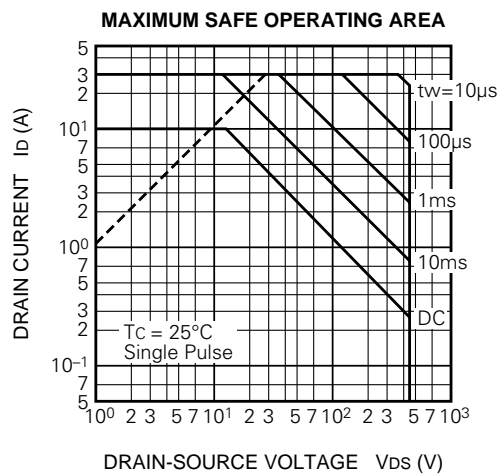
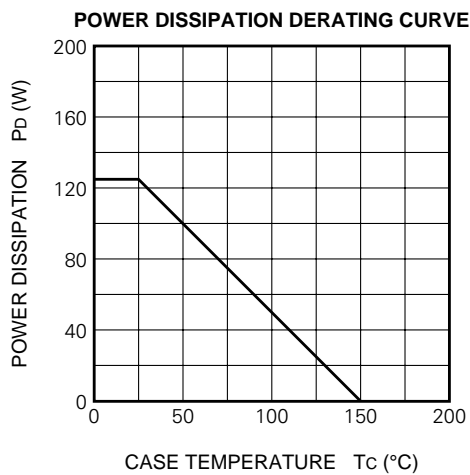

OUTPUT CHARACTERISTICS (TYPICAL)

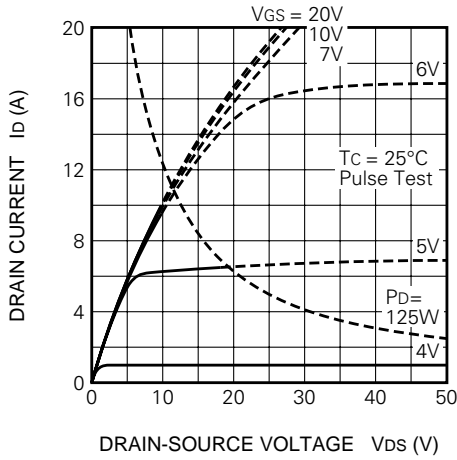

OUTPUT CHARACTERISTICS (TYPICAL)

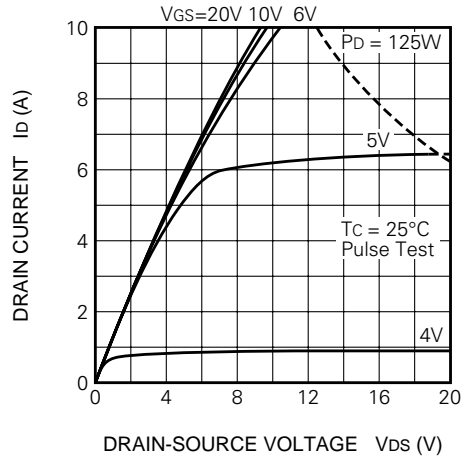

ON-STATE VOLTAGE VS. GATE-SOURCE VOLTAGE (TYPICAL)

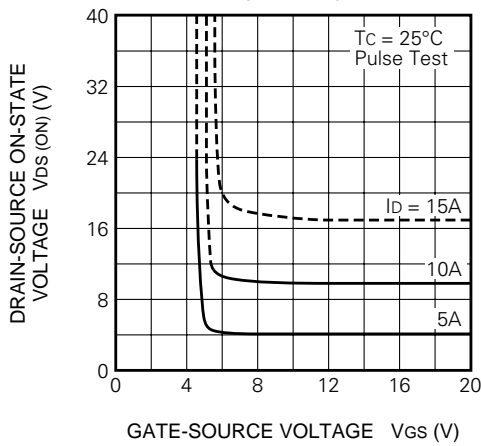

ON-STATE RESISTANCE VS. DRAIN CURRENT (TYPICAL)

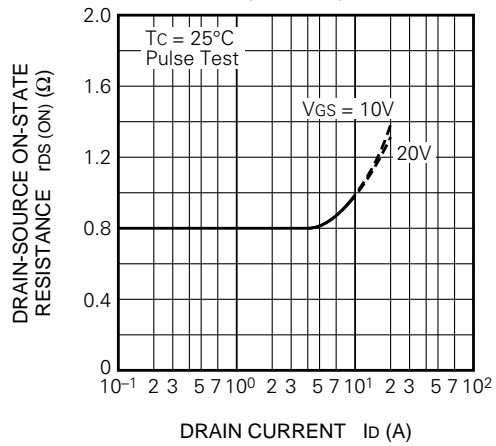

TRANSFER CHARACTERISTICS (TYPICAL)

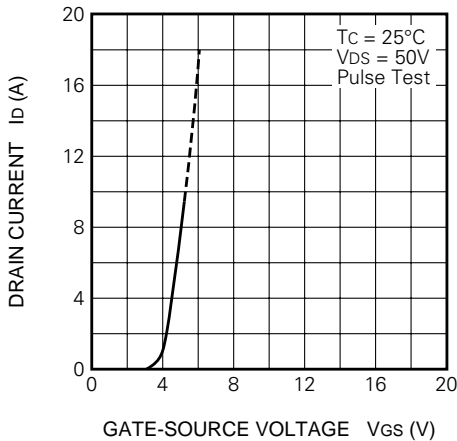

FORWARD TRANSFER ADMITTANCE VS. DRAIN CURRENT (TYPICAL)

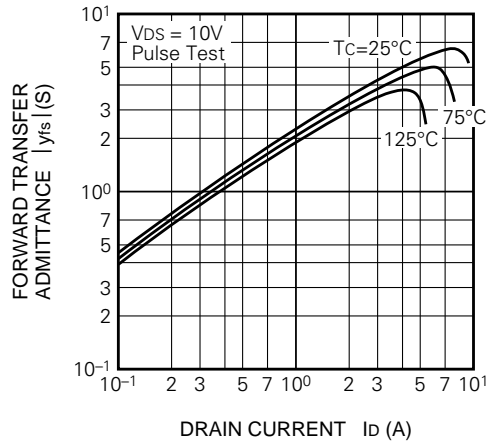

CAPACITANCE VS. DRAIN-SOURCE VOLTAGE (TYPICAL)

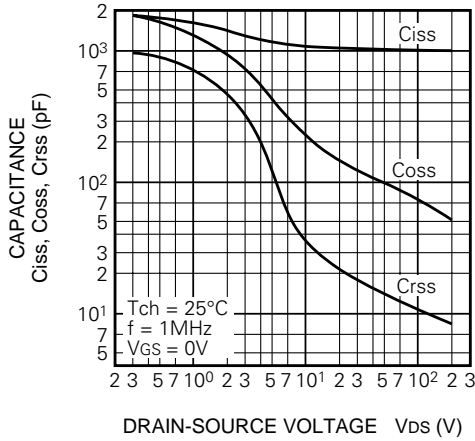

SWITCHING CHARACTERISTICS (TYPICAL)

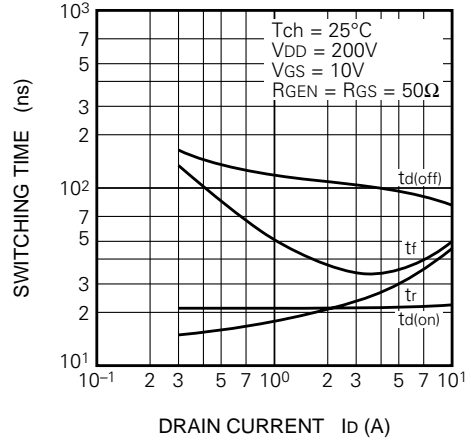

GATE-SOURCE VOLTAGE VS. GATE CHARGE (TYPICAL)

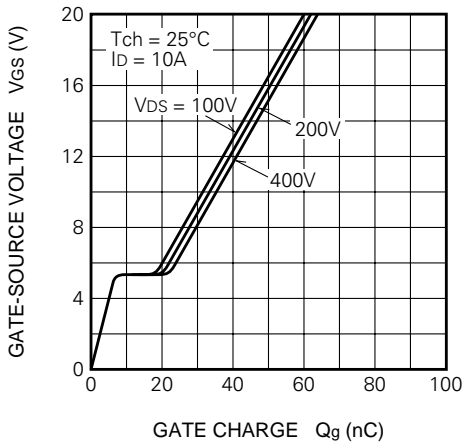

SOURCE-DRAIN DIODE FORWARD CHARACTERISTICS (TYPICAL)

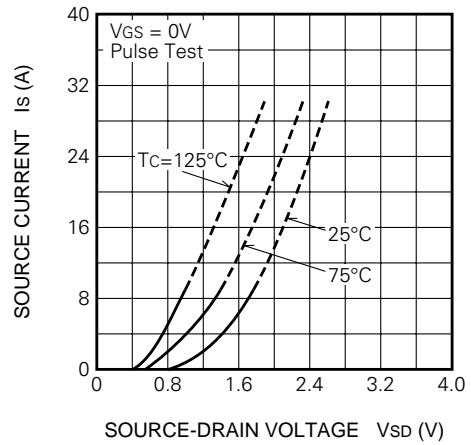

ON-STATE RESISTANCE VS. CHANNEL TEMPERATURE (TYPICAL)

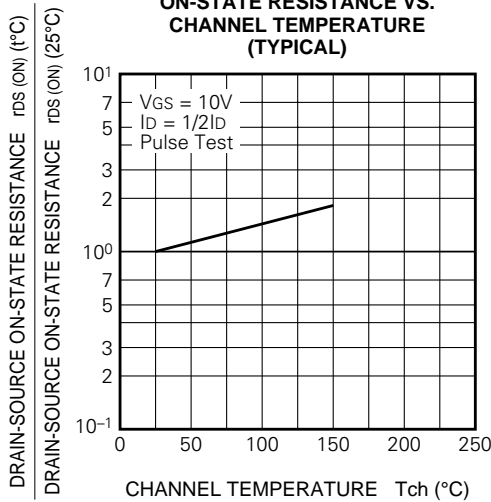

THRESHOLD VOLTAGE VS. CHANNEL TEMPERATURE (TYPICAL)

