



400mA CMOS LDO Regulator (Preliminary)

CYT6167

Description

The CYT6167 is an efficient linear voltage regulator. It has extra low dropout voltage. At light loads the typical dropout voltage is 15mV, at full load the typical dropout voltage is 600mV. The output voltage accuracy is better than 2%.

The CYT6167 has low ground current at 65uA, so it can help prolong battery life. The CYT6167 is specially designed for hand-held, battery-powered devices.

Features

- Typical 175mV dropout voltage at 150mA.
- Low Ground current at 65uA. (Typ.)
- Guaranteed 400mA output over the full operating temperature range.
- Extremely tight load and line regulation.
- Low temperature coefficient.
- Current and thermal limiting.
- No-load stability.
- Available in SOT-23-3L and TO-92 Packages.

Applications

- CD/DVD-ROM, CD/RW
- Wireless LAN card, Keyboard, Mouse
- Battery Powered Equipments
- PCMCIA Card

Ordering/Marking Information

Package	Ordering Information		Marking Information	
<p>TO-92 N-Pinout (Top View)</p>	3.3V	CYT6167AHN	CYT6167AHN YYWW	YY: year code WW: week code.
	2.8V	CYT6167BHN	CYT6167BHN YYWW	
	2.5V	CYT6167CHN	CYT6167CHN YYWW	
	1.8V	CYT6167DHN	CYT6167DHN YYWW	
	1.5V	CYT6167EHN	CYT6167EHN YYWW	
	3.0V	CYT6167FHN	CYT6167FHN YYWW	
<p>TO-92 G-Pinout (Top View)</p>	3.3V	CYT6167AHG	CYT6167AHG YYWW	
	2.8V	CYT6167BHG	CYT6167BHG YYWW	
	2.5V	CYT6167CHG	CYT6167CHG YYWW	
	1.8V	CYT6167DHG	CYT6167DHG YYWW	
	1.5V	CYT6167EHG	CYT6167EHG YYWW	
	3.0V	CYT6167FHG	CYT6167FHG YYWW	



400mA CMOS LDO Regulator (Preliminary)

CYT6167

Ordering/Marking Information (Continued)

Package	Ordering Information		Marking Information	
<p>SOT-23-3L N-Pinout (Top View)</p>	3.3V	CYT6167ALN	167AN_	<p>Starting with 1, a bar on top of 1 is for production year 2001, and underlined 1 is for year 2002. The next character is marked on top for 2003, and underlined for 2004. The naming pattern continues with consecutive characters for later years.</p> <p>The last character is the week code. (A-Z: 1-26, a-z: 27-52)</p>
	2.8V	CYT6167BLN	167BN_	
	2.5V	CYT6167CLN	_167CN_	
	1.8V	CYT6167DLN	_167DN_	
	1.5V	CYT6167ELN	_167EN_	
	3.0V	CYT6167FLN	_167FN_	
<p>SOT-23-3L G-Pinout (Top View)</p>	3.3V	CYT6167ALG	_167AG_	
	2.8V	CYT6167BLG	_167BG_	
	2.5V	CYT6167CLG	_167CG_	
	1.8V	CYT6167DLG	_167DG_	
	1.5V	CYT6167ELG	_167EG_	
	3.0V	CYT6167FLG	_167FG_	



400mA CMOS LDO Regulator (Preliminary)

CYT6167

Absolute Maximum Ratings⁽¹⁾

Supply Input Voltage (VIN) -0.7V to +6V
 Power Dissipation (PD) Internally Limited ⁽³⁾
 Junction Temperature (TJ) 0°C to +125°C
 Lead Temperature (soldering, 5 sec.) 260°C
 Storage Temperature (TS) -40°C to +150°C

Operating Ratings⁽²⁾

Supply Input Voltage (VIN) +2.8V to +6V
 Junction Temperature (TJ) 0°C to +125°C
 Package Thermal Resistance
 160°C/W (TO-92)
 250°C/W (SOT-23-3L)

Electrical Characteristics

V_{IN} = V_{OUT} + 1.0V; C_{IN} = 2.2μF; C_{OUT} = 2.2μF; I_{OUT} = 10mA; T_J = 25°C, unless otherwise specified.

Symbol	Parameter	Conditions	Min	Typ	Max	Units
V _{OUT}	Output Voltage Accuracy	CYT6167-1.5V	1.470	1.5	1.530	V
		CYT6167-1.8V	1.764	1.8	1.836	
		CYT6167-2.5V	2.450	2.5	2.550	
		CYT6167-2.8V	2.744	2.8	2.856	
		CYT6167-3.0V	2.940	3.0	3.060	
		CYT6167-3.3V	3.234	3.3	3.366	
ΔV _{OUT} / ΔT	Output Voltage Temperature Coefficient	Note 4	--	0.025	--	mV/°C
ΔV _{OUT} / V _{OUT}	Line Regulation	V _{IN} = 4.3V to 6V, I _{OUT} = 10mA (V _{OUT} = 3.3V)	--	1.0	--	%/V
ΔV _{OUT} / V _{OUT}	Load Regulation ⁽⁵⁾	V _{IN} = 5V, I _{OUT} = 10mA to 400mA (V _{OUT} = 3.3V)	--	1.0	--	%
V _{IN} - V _{OUT}	Dropout Voltage ⁽⁶⁾	I _{OUT} = 10mA	--	15	--	mV
		I _{OUT} = 150mA	--	175	--	
		I _{OUT} = 300mA	--	380	--	
		I _{OUT} = 400mA	--	600	--	
T _{PROTECTION}	Thermal Protection	Thermal Protection Temperature	--	150	--	°C
		Protection Hysteresis	--	20	--	°C
PSRR	Ripple Rejection	f = 120Hz	--	59	--	dB
I _{GROUND}	Ground Current	I _{OUT} = 10mA	--	65	--	uA
I _{LIMIT}	Current Limit	V _{OUT} = 0V	--	600	--	mA



400mA CMOS LDO Regulator (Preliminary)

CYT6167

Note 1: Exceeding the absolute maximum rating may damage the device.

Note 2: The device is not guaranteed to function outside its operating rating.

Note 3: The maximum allowable power dissipation at any TA (ambient temperature) is calculated using: $P_{D(MAX)} = (T_{J(MAX)} - T_A)/\theta_{JA}$. Exceeding the maximum allowable power dissipation will result in excessive die temperature, and the regulator will go into thermal shutdown. See Table 1 and the “Thermal Considerations” section for details.

Note 4: Output voltage temperature coefficient is the worst-case voltage change divided by the total temperature range.

Note 5: Regulation is measured at constant junction temperature using low duty cycle pulse testing. Parts are tested for load regulation in the load range from 100 μ A to 400mA. Changes in output voltage due to heating effects are covered by the thermal regulation specification.

Note 6: Dropout voltage is defined as the input to output differential at which the output voltage drops 2% below its nominal value measured at 1V differential.

Typical Application

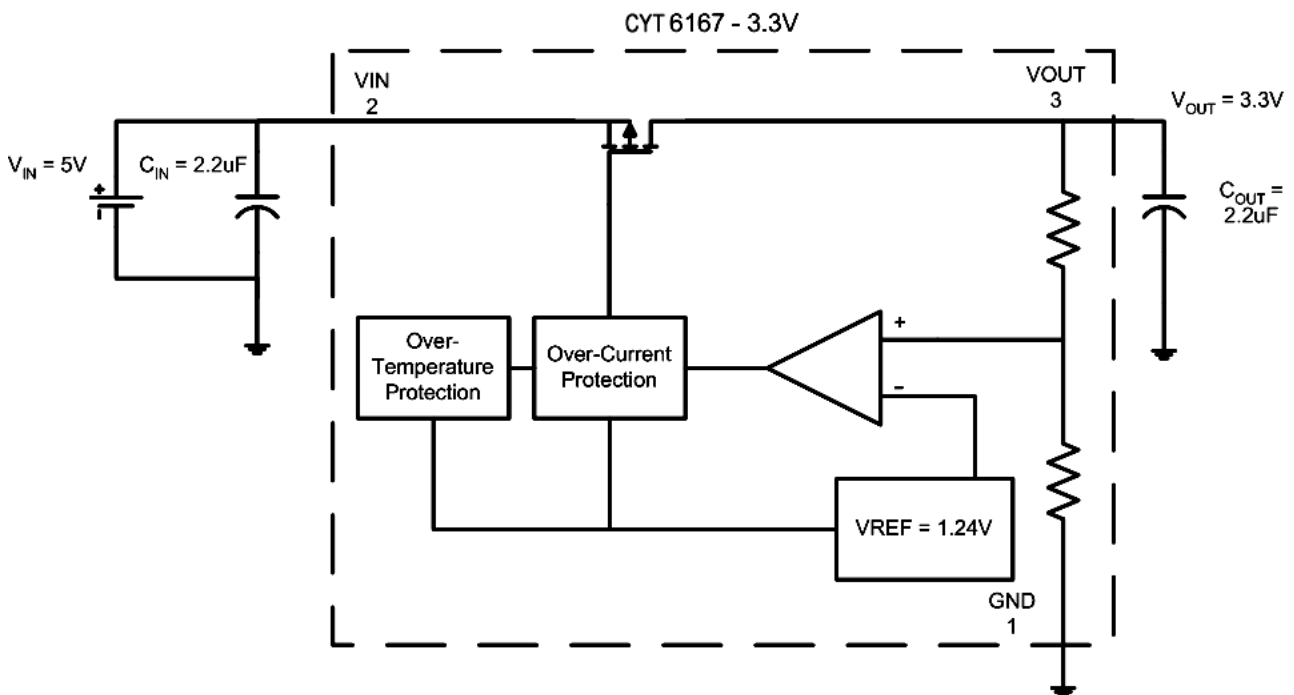



400mA CMOS LDO Regulator (Preliminary)

CYT6167

Line Regulation (VOUT = 3.3V)

(VIN = 4.3V to 6V, IOU = 10mA)

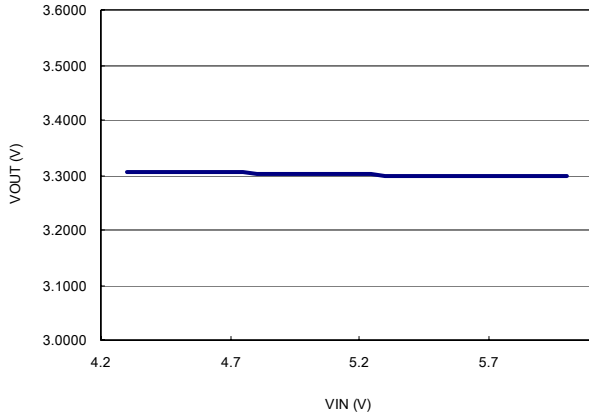

Load Regulation (VOUT = 3.3V)

(VIN = 5V, IOU = 10mA to 500mA)

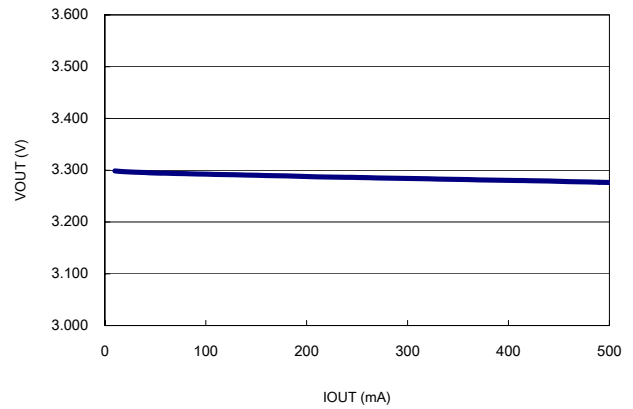

Output Voltage vs Temperature

(VIN = 5V, IOU = 10mA)

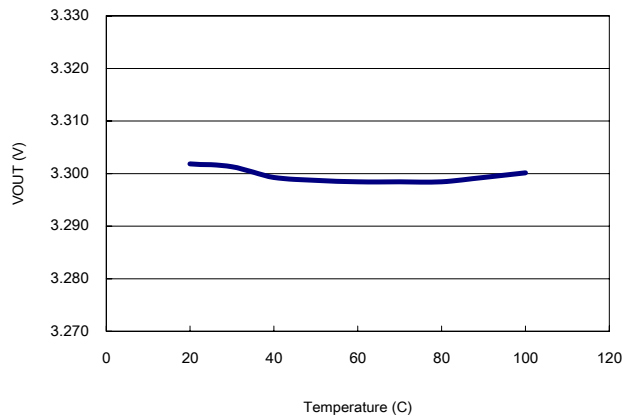

IQ vs IOU (VOUT = 3.3V)

(VIN = 5V, IOU = 10mA to 500mA)

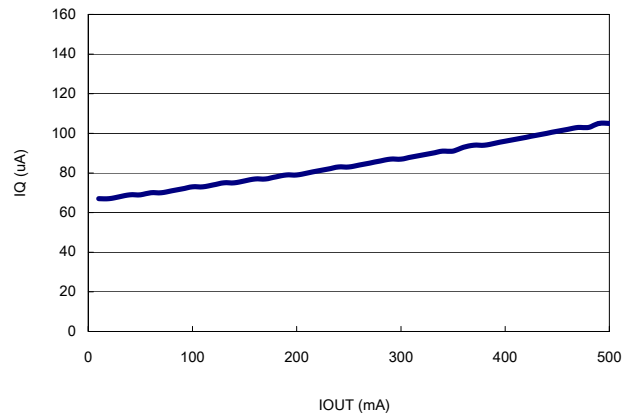

PSRR (VOUT = 3.3)

(VIN = 5V, VPP = 1V)

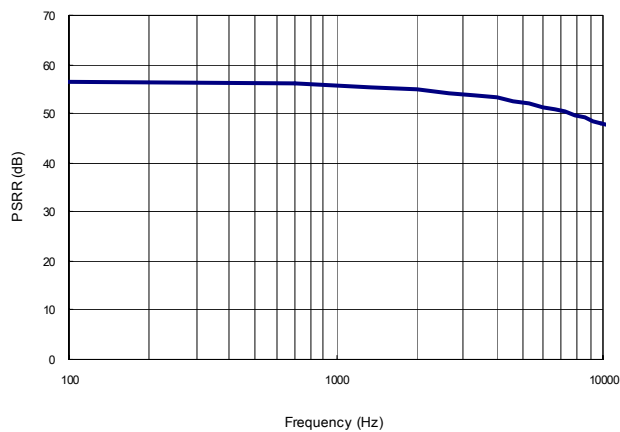

Transient Response (VOUT = 3.3V)

(IOU = 10mA to 40mA)

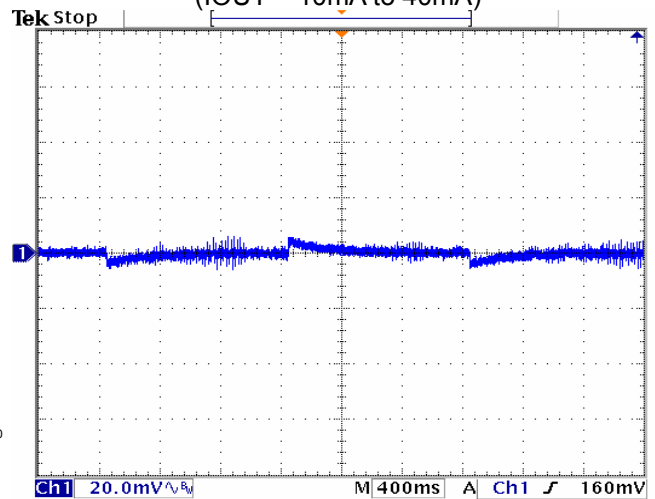



Application Hints

Like any Low dropout regulator, CYT6167 requires external capacitors to ensure stability. The external capacitors must be carefully selected to ensure the performances.

Input Capacitor:

An Input Capacitor of at least 2.2uF is required. Ceramic or Tantalum can be used. The value can be increased without upper limit.

Output Capacitor:

An Output Capacitor is required for look stability. It must be located no more than 1cm away from the V_{OUT} pin, and connected directly between V_{OUT} and GND pins. The minimum value is 2.2uF but once again its value can be increased without limit.

Thermal Consideration

It is important that the thermal limit of the package should not be exceeded. The CYT6167 has built-in thermal protection. When the thermal limit is exceeded, the IC will enter protection, and the V_{OUT} will be reset to zero. The power dissipation for a given application can be calculated as follows:

The Power Dissipation (P_D) is

$$P_D = I_{OUT} * [V_{IN} - V_{OUT}]$$

The thermal limit of the package is then limited to $P_{D(MAX)} = [T_J - T_A]/\theta_{JA}$ where T_J is the junction temperature, T_A is ambient temperature, and θ_{JA} is around 250°C/W for CYT6167. CYT6167 is designed to enter thermal protection at 150°C. For example, if T_A is 25°C then the max P_D is limited to about 0.5W. In other words, if $I_{OUT(MAX)} = 400mA$, then $[V_{IN} - V_{OUT}]$ can not exceed 1.25V.



**400mA CMOS LDO
Regulator
(Preliminary)**

CYT6167

OUTLINE DRAWING SOT-23-3L (SC-59)

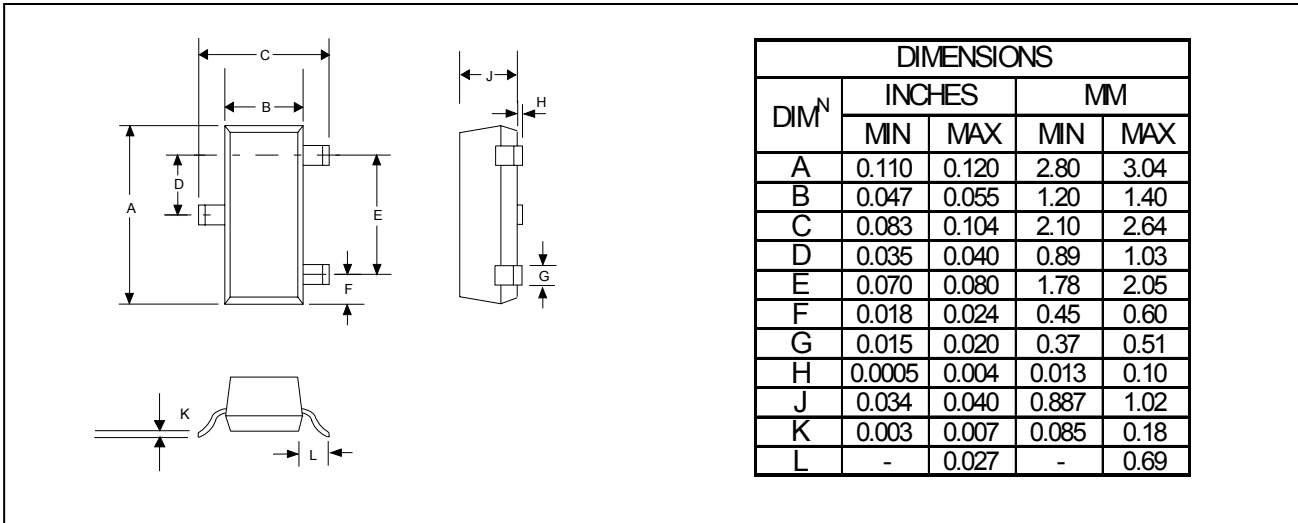

OUTLINE DRAWING TO-92

