

## GENERAL DESCRIPTION

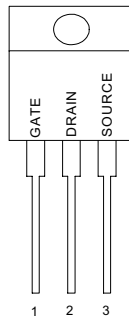
This Power MOSFET is designed to withstand high energy in avalanche and commutation modes. The new energy efficient design also offers a drain-to-source diode with a fast recovery time. Designed for high voltage, high speed switching applications in power supplies, converters and PWM motor controls, these devices are particularly well suited for bridge circuits where diode speed and commutating safe operating areas are critical and offer additional and safety margin against unexpected voltage transients.

## FEATURES

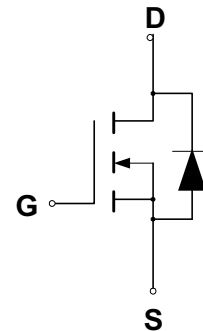
- ◆ Avalanche Energy Specified
- ◆ Source-to-Drain Diode Recovery Time Comparable to a Discrete Fast Recovery Diode
- ◆ Diode is Characterized for Use in Bridge Circuits
- ◆  $I_{DSS}$  and  $V_{DS(on)}$  Specified at Elevated Temperature

## PIN CONFIGURATION

TO-220  
Top View



## SYMBOL



N-Channel MOSFET

## ABSOLUTE MAXIMUM RATINGS

Rating	Symbol	Value	Unit
Drain to Current — Continuous	$I_D$	16	A
— Pulsed	$I_{DM}$	56	
Gate-to-Source Voltage — Continue	$V_{GS}$	$\pm 20$	V
— Non-repetitive	$V_{GSM}$	$\pm 32$	V
Total Power Dissipation	$P_D$	125	W
Derate above 25°C		1.0	W/°C
Operating and Storage Temperature Range	$T_J, T_{STG}$	-55 to 150	°C
Single Pulse Drain-to-Source Avalanche Energy — $T_J = 25^\circ\text{C}$ ( $V_{DD} = 100\text{V}, V_{GS} = 10\text{V}, I_L = 20\text{A}, L = 10\text{mH}, R_G = 25\Omega$ )	$E_{AS}$	384	mJ
Thermal Resistance — Junction to Case	$\theta_{JC}$	1.0	°C/W
— Junction to Ambient	$\theta_{JA}$	62.5	
Maximum Lead Temperature for Soldering Purposes, 1/8" from case for 10 seconds	$T_L$	260	°C

## ELECTRICAL CHARACTERISTICS

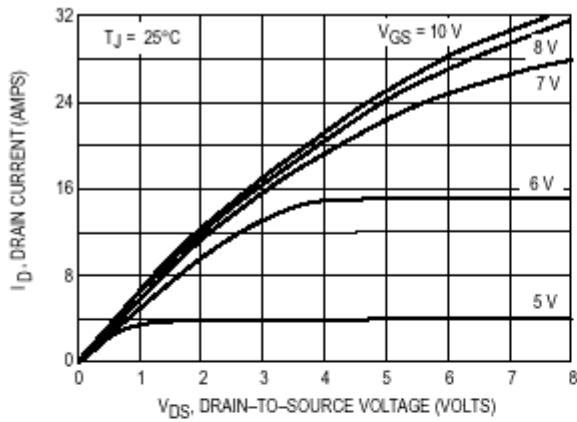
Unless otherwise specified,  $T_J = 25^\circ\text{C}$ .

Characteristic	Symbol	Min	Typ	Max	Units	
Drain-Source Breakdown Voltage ( $V_{GS} = 0\text{ V}$ , $I_D = 250\ \mu\text{A}$ )	$V_{(BR)DSS}$	250			V	
Drain-Source Leakage Current ( $V_{DS} = 250\text{ V}$ , $V_{GS} = 0\text{ V}$ ) ( $V_{DS} = 250\text{ V}$ , $V_{GS} = 0\text{ V}$ , $T_J = 125^\circ\text{C}$ )	$I_{DSS}$			10 100	$\mu\text{A}$	
Gate-Source Leakage Current-Forward ( $V_{gsf} = 20\text{ V}$ , $V_{DS} = 0\text{ V}$ )	$I_{GSSF}$			100	nA	
Gate-Source Leakage Current-Reverse ( $V_{gsr} = 20\text{ V}$ , $V_{DS} = 0\text{ V}$ )	$I_{GSSR}$			100	nA	
Gate Threshold Voltage ( $V_{DS} = V_{GS}$ , $I_D = 250\ \mu\text{A}$ )	$V_{GS(th)}$	2.0	3.0	4.0	V	
Static Drain-Source On-Resistance ( $V_{GS} = 10\text{ V}$ , $I_D = 8.0\text{A}$ ) *	$R_{DS(on)}$		0.17	0.25	$\Omega$	
Drain-Source On-Voltage ( $V_{GS} = 10\text{ V}$ ) ( $I_D = 16.0\text{ A}$ )	$V_{DS(on)}$		3.6	4.8	V	
Forward Transconductance ( $V_{DS} = 15\text{ V}$ , $I_D = 8.0\text{A}$ ) *	$g_{FS}$	3.0	7.0		S	
Input Capacitance	$(V_{DS} = 25\text{ V}$ , $V_{GS} = 0\text{ V}$ , $f = 1.0\text{ MHz}$ )	$C_{iss}$	1558	2180	pF	
Output Capacitance		$C_{oss}$	281	390	pF	
Reverse Transfer Capacitance		$C_{rss}$	130	260	pF	
Turn-On Delay Time	$(V_{DD} = 125\text{ V}$ , $I_D = 16\text{ A}$ , $V_{GS} = 10\text{ V}$ , $R_G = 9.1\Omega$ ) *	$t_{d(on)}$	15	30	ns	
Rise Time		$t_r$	64	130	ns	
Turn-Off Delay Time		$t_{d(off)}$	56	110	ns	
Fall Time		$t_f$	44	90	ns	
Total Gate Charge	$(V_{DS} = 200\text{ V}$ , $I_D = 16\text{ A}$ , $V_{GS} = 10\text{ V}$ ) *	$Q_g$	53.4	70	nC	
Gate-Source Charge		$Q_{gs}$	9.3		nC	
Gate-Drain Charge		$Q_{gd}$	27.5		nC	
Internal Drain Inductance (Measured from the drain lead 0.25" from package to center of die)	$L_D$		4.5		nH	
Internal Drain Inductance (Measured from the source lead 0.25" from package to source bond pad)	$L_S$		7.5		nH	
<b>SOURCE-DRAIN DIODE CHARACTERISTICS</b>						
Forward On-Voltage(1)	$(I_S = 16\text{ A}$ , $V_{GS} = 0\text{ V}$ , $d_i/d_t = 100\text{A}/\mu\text{s}$ )	$V_{SD}$		0.915	1.5	V
Forward Turn-On Time		$t_{on}$		**		ns
Reverse Recovery Time		$t_{rr}$		234		ns

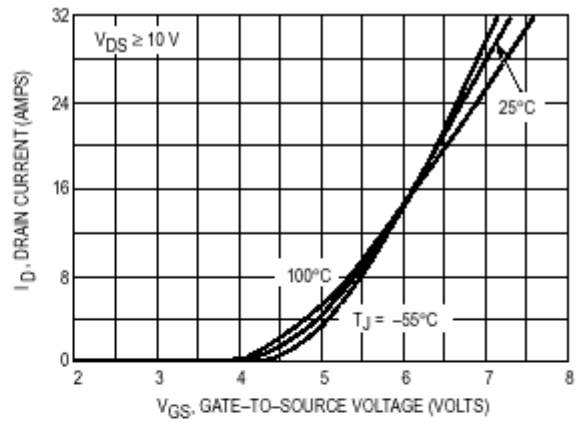
\* Pulse Test: Pulse Width  $\leq 300\mu\text{s}$ , Duty Cycle  $\leq 2\%$

\*\* Negligible, Dominated by circuit inductance

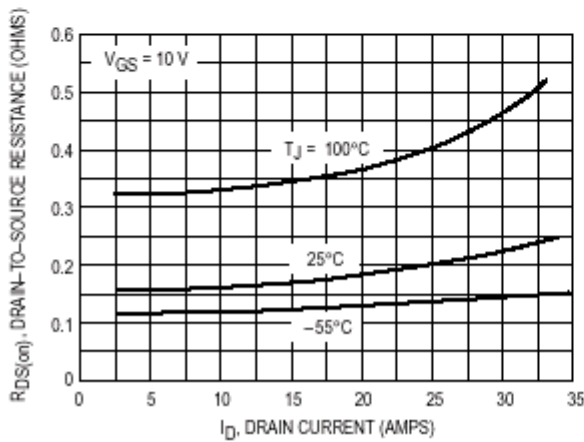
**TYPICAL ELECTRICAL CHARACTERISTICS**



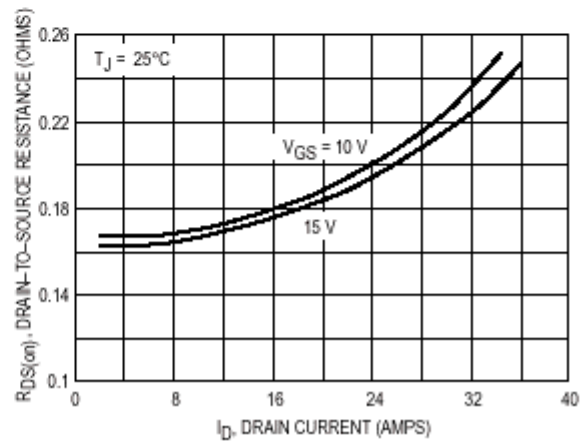
**Figure 1. On-Region Characteristics**



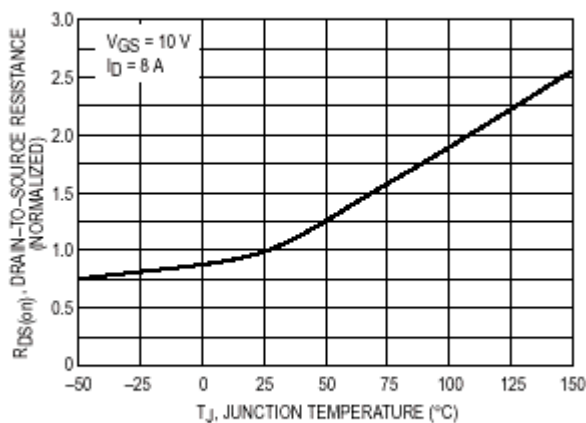
**Figure 2. Transfer Characteristics**



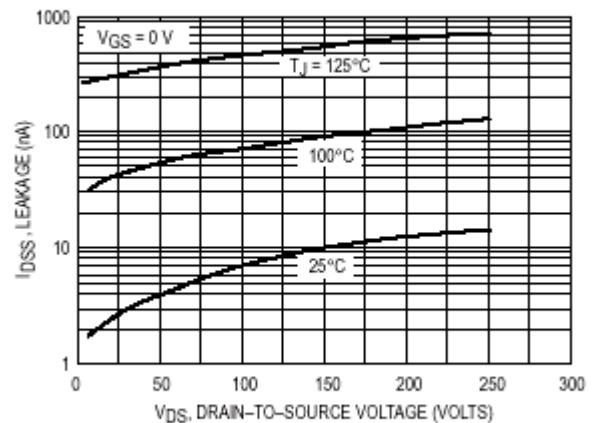
**Figure 3. On-Resistance versus Drain Current and Temperature**



**Figure 4. On-Resistance versus Drain Current and Gate Voltage**

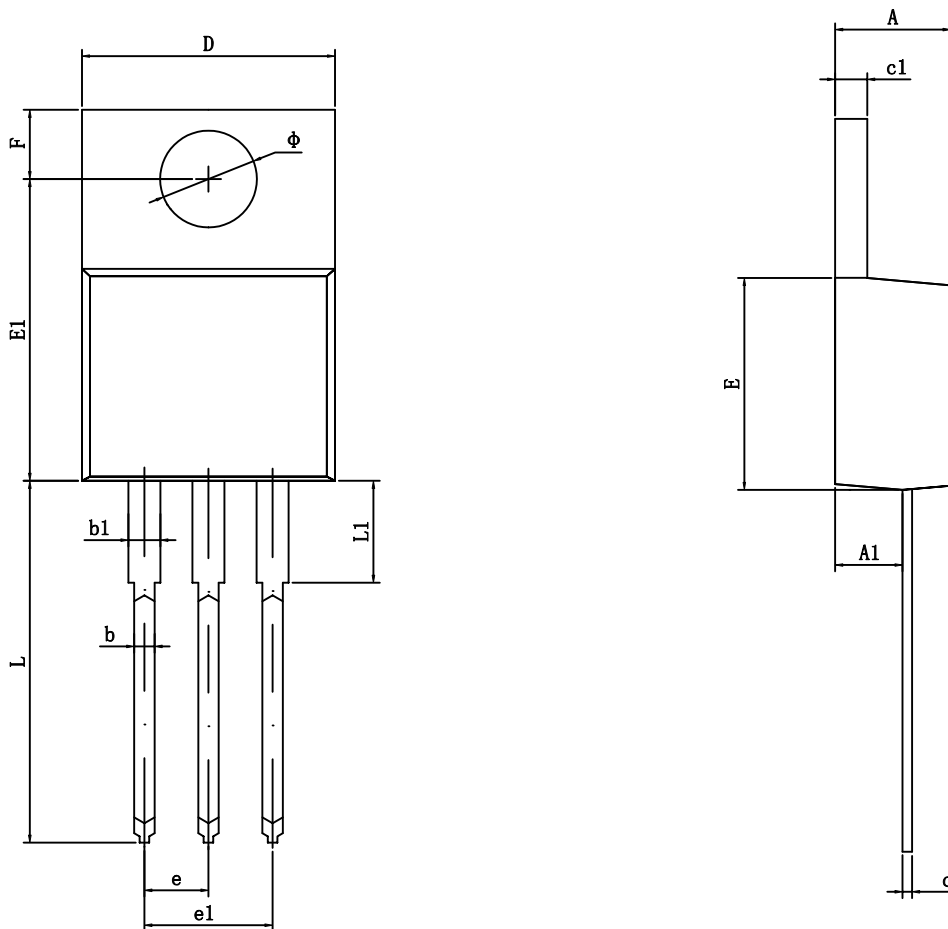


**Figure 5. On-Resistance Variation with Temperature**



**Figure 6. Drain-To-Source Leakage Current versus Voltage**

**TO-220 PACKAGE OUTLINE DIMENSIONS**



Symbol	Dimensions In Millimeters		Dimensions In Inches	
	Min	Max	Min	Max
A	4.470	4.670	0.176	0.184
A1	2.520	2.820	0.099	0.111
b	0.710	0.910	0.028	0.036
b1	1.170	1.370	0.046	0.054
c	0.310	0.530	0.012	0.021
c1	1.170	1.370	0.046	0.054
D	10.010	10.310	0.394	0.406
E	8.500	8.900	0.335	0.350
E1	12.060	12.460	0.475	0.491
e	2.540TYP		0.100TYP	
e1	4.980	5.180	0.196	0.204
F	2.590	2.890	0.102	0.114
L	13.400	13.800	0.528	0.543
L1	3.560	3.960	0.140	0.156
Φ	3.790	3.890	0.149	0.153