

Silicon NPN High Voltage Switching Transistor

Features

- Simple-sWitch-Off Transistor (SWOT)
- HIGH SPEED technology
- Planar passivation
- 100 kHz switching rate
- Very low switching losses
- Very low dynamic saturation
- Very low operating temperature
- Optimized RBSOA
- High reverse voltage

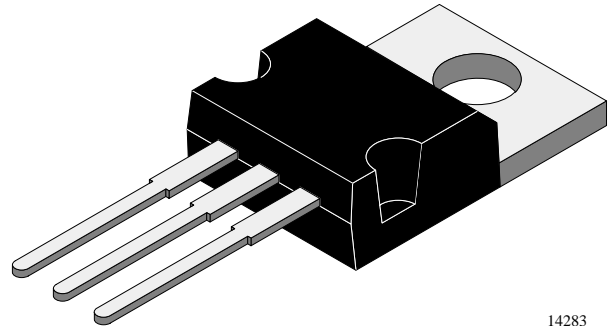

14283

Applications

Electronic lamp ballast circuits
Switch-mode power supplies

Absolute Maximum Ratings

$T_{\text{case}} = 25^{\circ}\text{C}$, unless otherwise specified

Parameter	Test Conditions	Symbol	Value	Unit
Collector-emitter voltage		V_{CEO}	400	V
		V_{CEW}	500	V
		V_{CES}	700	V
Emitter-base voltage		V_{EBO}	9	V
Collector current		I_{C}	4	A
Collector peak current		I_{CM}	6	A
Base current		I_{B}	2	A
Base peak current		I_{BM}	3	A
Total power dissipation	$T_{\text{case}} \leq 25^{\circ}\text{C}$	P_{tot}	40	W
Junction temperature		T_{j}	150	$^{\circ}\text{C}$
Storage temperature range		T_{stg}	-65 to +150	$^{\circ}\text{C}$

Maximum Thermal Resistance

$T_{\text{case}} = 25^{\circ}\text{C}$, unless otherwise specified

Parameter	Test Conditions	Symbol	Value	Unit
Junction case		R_{thJC}	3.12	K/W

Electrical Characteristics

$T_{\text{case}} = 25^{\circ}\text{C}$, unless otherwise specified

Parameter	Test Conditions	Symbol	Min	Typ	Max	Unit
Collector cut-off current	$V_{\text{CE}} = 700 \text{ V}$	I_{CES}			50	μA
	$V_{\text{CE}} = 700 \text{ V}; T_{\text{case}} = 150^{\circ}\text{C}$	I_{CES}			0.5	mA
Collector-emitter breakdown voltage (figure 1)	$I_{\text{C}} = 300 \text{ mA}; L = 125 \text{ mH}; I_{\text{measure}} = 100 \text{ mA}$	$V_{(\text{BR})\text{CEO}}$	400			V
Emitter-base breakdown voltage	$I_{\text{E}} = 1 \text{ mA}$	$V_{(\text{BR})\text{EBO}}$	9			V
Collector-emitter saturation voltage	$I_{\text{C}} = 0.6 \text{ A}; I_{\text{B}} = 0.15 \text{ A}$	V_{CEsat}		0.1	0.2	V
	$I_{\text{C}} = 2 \text{ A}; I_{\text{B}} = 0.7 \text{ A}$	V_{CEsat}		0.2	0.3	V
Base-emitter saturation voltage	$I_{\text{C}} = 0.6 \text{ A}; I_{\text{B}} = 0.15 \text{ A}$	V_{BEsat}		0.9	1.1	V
	$I_{\text{C}} = 2 \text{ A}; I_{\text{B}} = 0.7 \text{ A}$	V_{BEsat}		1	1.2	V
DC forward current transfer ratio	$V_{\text{CE}} = 2 \text{ V}; I_{\text{C}} = 10 \text{ mA}$	h_{FE}	15			
	$V_{\text{CE}} = 2 \text{ V}; I_{\text{C}} = 0.6 \text{ A}$	h_{FE}	15			
	$V_{\text{CE}} = 2 \text{ V}; I_{\text{C}} = 2 \text{ A}$	h_{FE}	7			
	$V_{\text{CE}} = 5 \text{ V}; I_{\text{C}} = 4 \text{ A}$	h_{FE}	4			
Collector-emitter working voltage	$V_{\text{S}} = 50 \text{ V}; L = 1 \text{ mH}; I_{\text{C}} = 4 \text{ A}; I_{\text{B}1} = 1.4 \text{ A}; -I_{\text{B}2} = 0.4 \text{ A}; -V_{\text{BB}} = 5 \text{ V}$	V_{CEW}	500			V
Dynamic saturation voltage	$I_{\text{C}} = 2 \text{ A}; I_{\text{B}} = 0.4 \text{ A}; t = 1 \mu\text{s}$	V_{CEsatdyn}		10	15	V
	$I_{\text{C}} = 2 \text{ A}; I_{\text{B}} = 0.4 \text{ A}; t = 3 \mu\text{s}$	V_{CEsatdyn}		2	4	V
Gain bandwidth product	$I_{\text{C}} = 500 \text{ mA}; V_{\text{CE}} = 10 \text{ V}; f = 1 \text{ MHz}$	f_{T}		8		MHz

Switching Characteristics

$T_{\text{case}} = 25^{\circ}\text{C}$, unless otherwise specified

Parameter	Test Conditions	Symbol	Min	Typ	Max	Unit
Resistive load (figure 2)						
Turn on time	$I_C = 0.6 \text{ A}; I_{B1} = 0.15 \text{ A};$ $-I_{B2} = 0.3 \text{ A}; V_S = 250 \text{ V}$	t_{on}		0.15	0.25	μs
Storage time		t_s		2.1	3	μs
Fall time		t_f		0.2	0.4	μs
Turn on time	$I_C = 2 \text{ A}; I_{B1} = 0.4 \text{ A};$ $-I_{B2} = 1 \text{ A}; V_S = 250 \text{ V}$	t_{on}		0.4	0.6	μs
Storage time		t_s		1	1.2	μs
Fall time		t_f		0.1	0.15	μs
Inductive load (figure 3)						
Storage time	$I_C = 0.6 \text{ A}; I_{B1} = 0.15 \text{ A}; -I_{B2} = 0.3 \text{ A};$ $V_{\text{clamp}} = 300 \text{ V}; L = 200 \mu\text{H}$	t_s		2.2	3	μs
Fall time		t_f		0.2	0.3	μs
Storage time	$I_C = 2 \text{ A}; I_{B1} = 0.4 \text{ A}; -I_{B2} = 1 \text{ A};$ $V_{\text{clamp}} = 300 \text{ V}; L = 200 \mu\text{H}$	t_s		1	1.3	μs
Fall time		t_f		0.1	0.15	μs

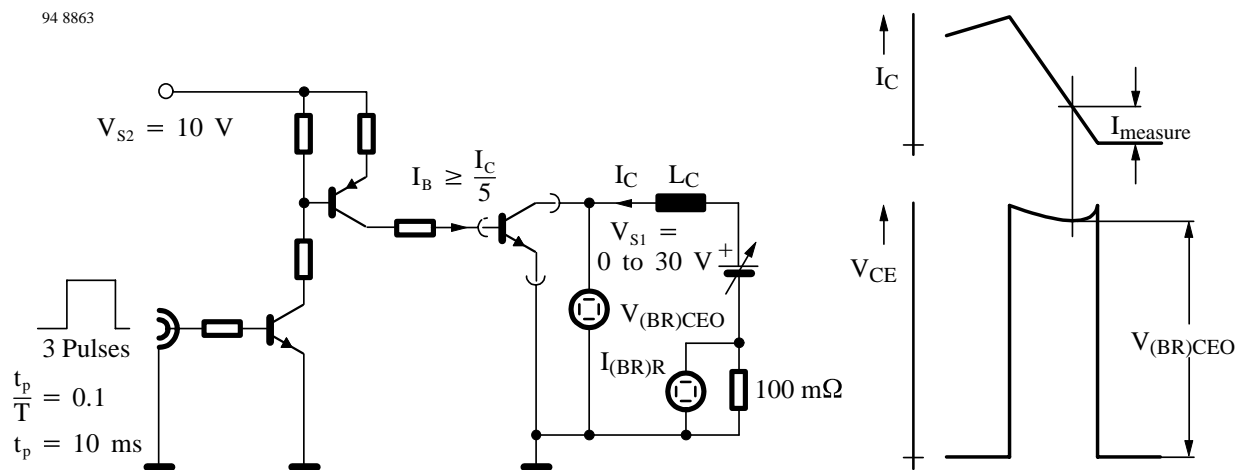

Figure 1. Test circuit for $V_{(BR)CEO}$

94 8852

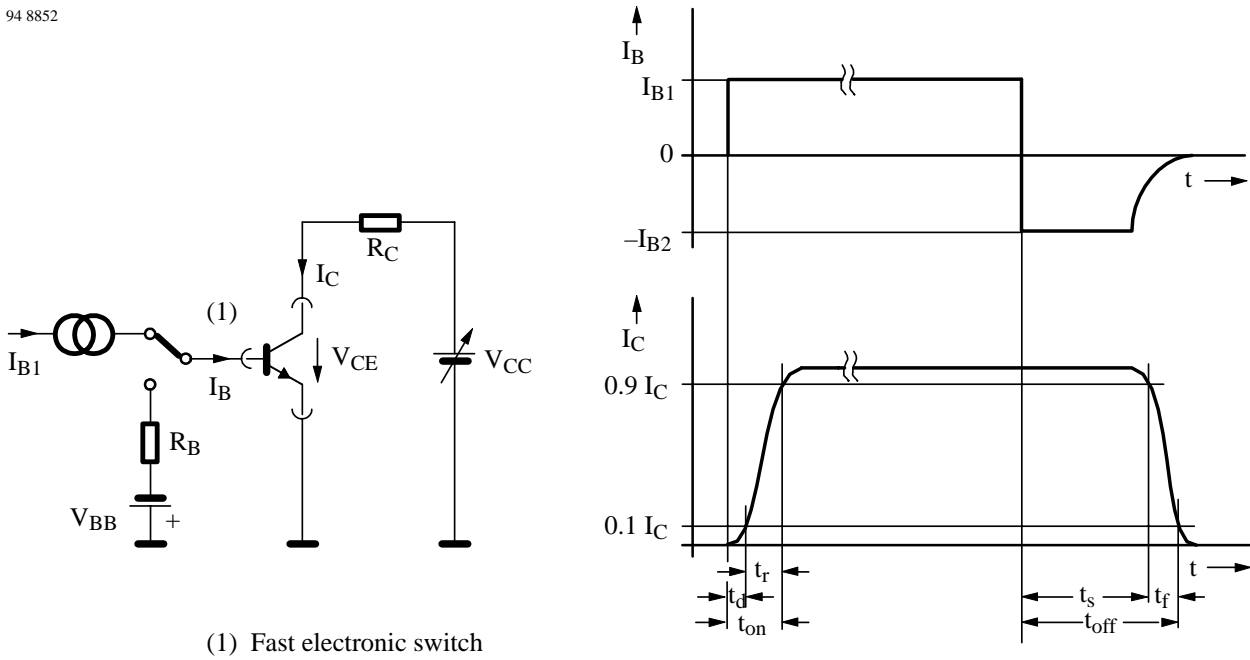

Figure 2. Test circuit for switching characteristics – resistive load

94 8853

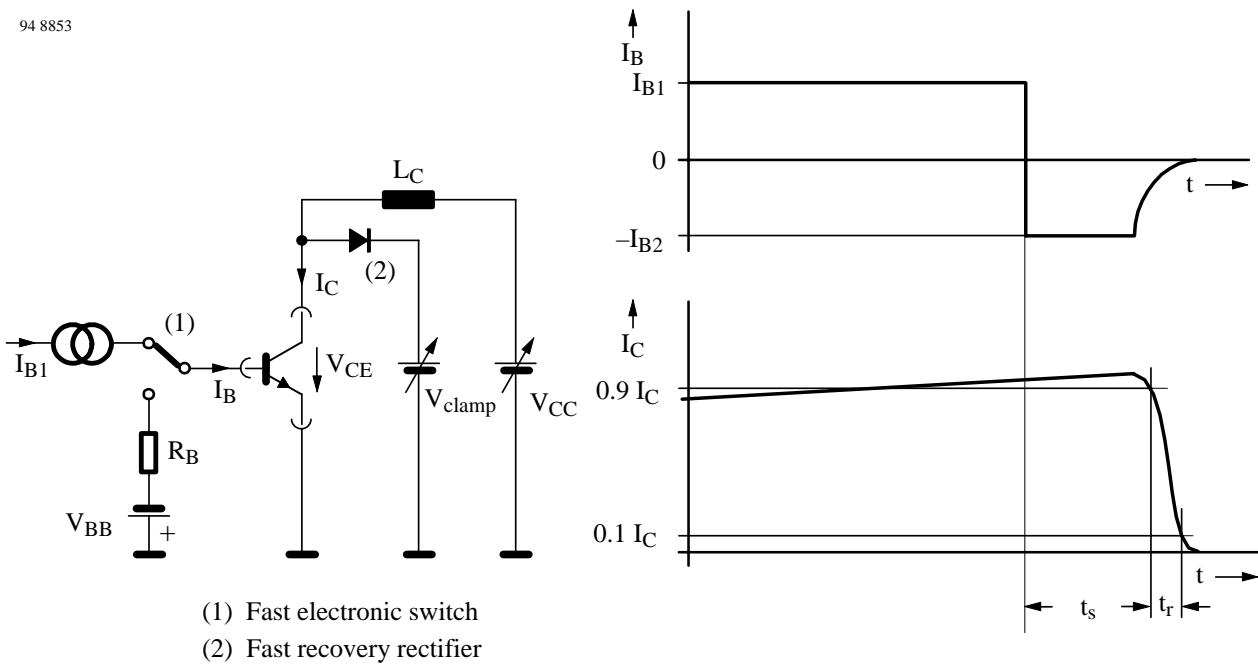
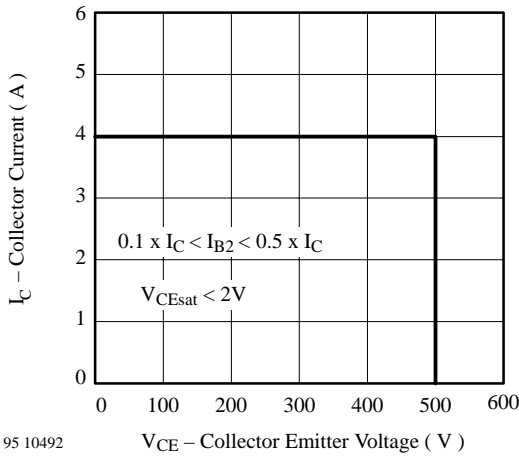

Figure 3. Test circuit for switching characteristics – inductive load

Typical Characteristics ($T_{case} = 25_C$ unless otherwise specified)



95 10492

Figure 4. V_{CEW} - Diagram

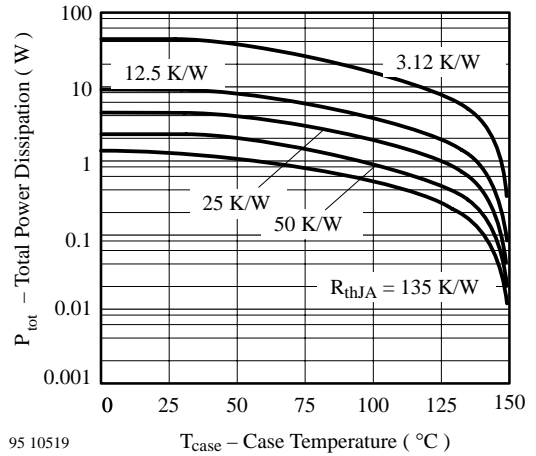

95 10519

Figure 7. P_{tot} vs. T_{case}

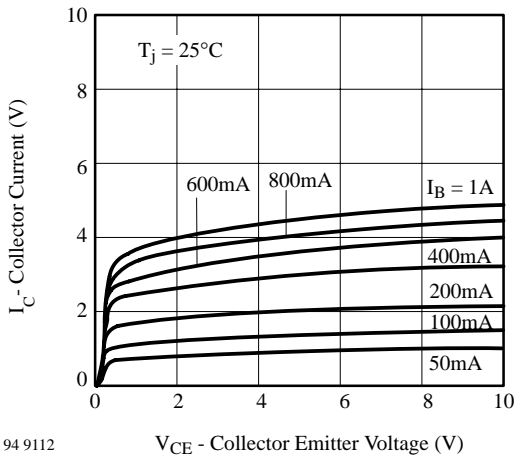

94 9112

Figure 5. I_C vs. V_{CE}

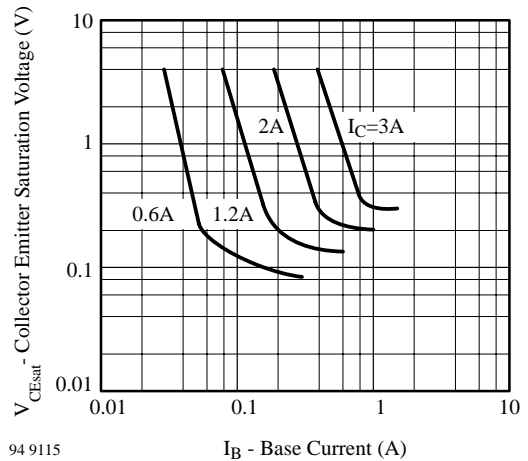

94 9115

Figure 8. V_{CEsat} vs. I_B

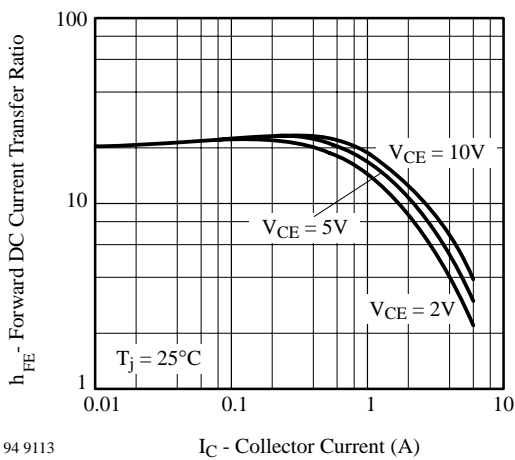

94 9113

Figure 6. h_{FE} vs. I_C

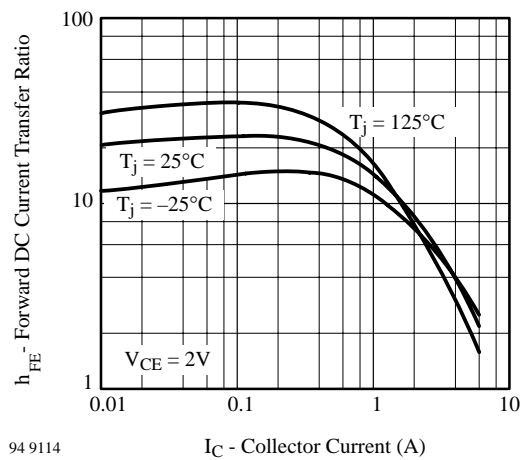

94 9114

Figure 9. h_{FE} vs. I_C

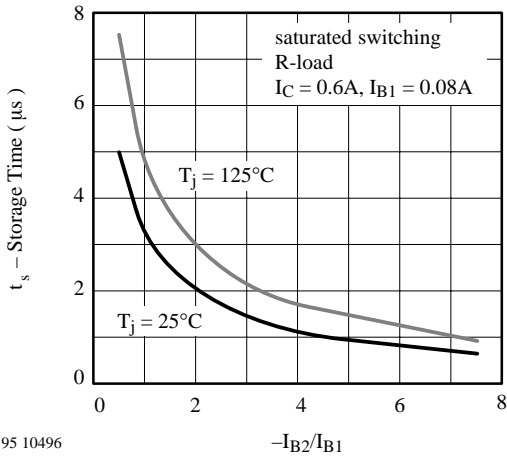

Figure 10. t_s vs. $-I_{B2}/I_{B1}$

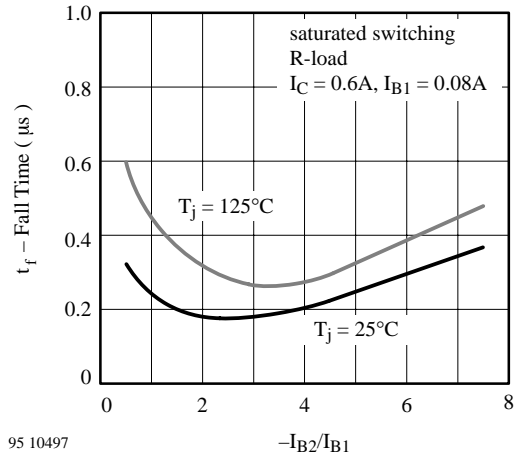

Figure 13. t_f vs. $-I_{B2}/I_{B1}$

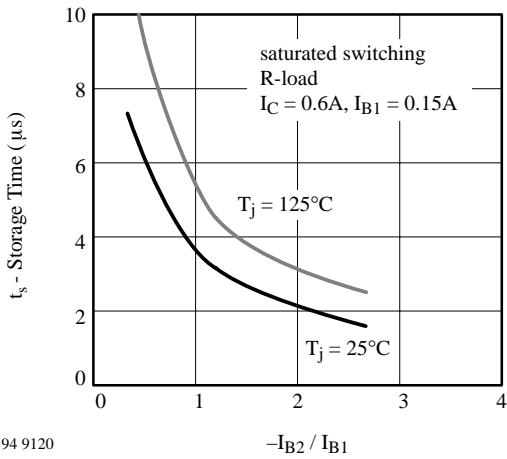

Figure 11. t_s vs. $-I_{B2}/I_{B1}$

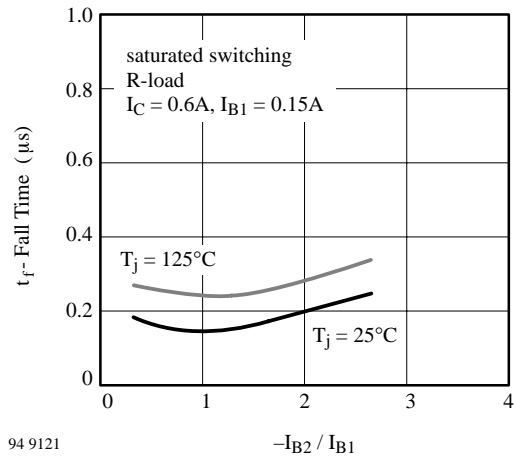

Figure 14. t_f vs. $-I_{B2}/I_{B1}$

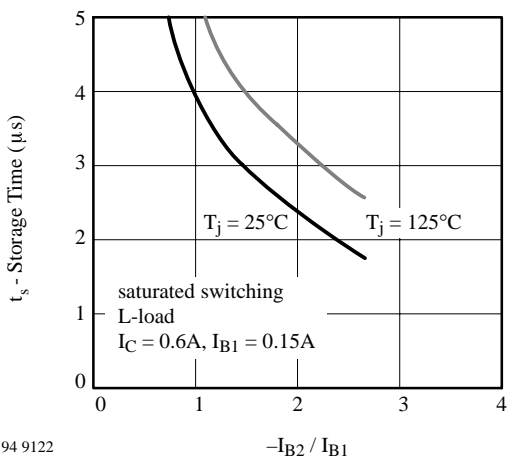

Figure 12. t_s vs. $-I_{B2}/I_{B1}$

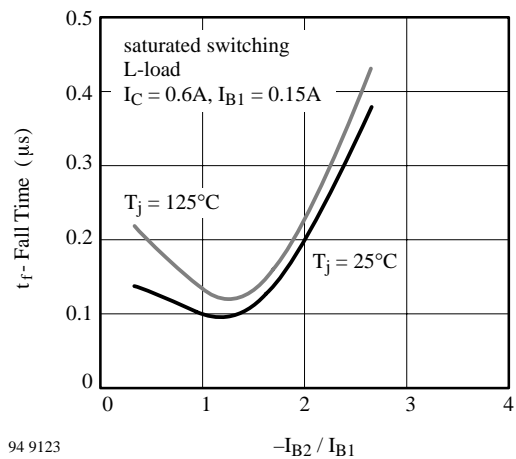
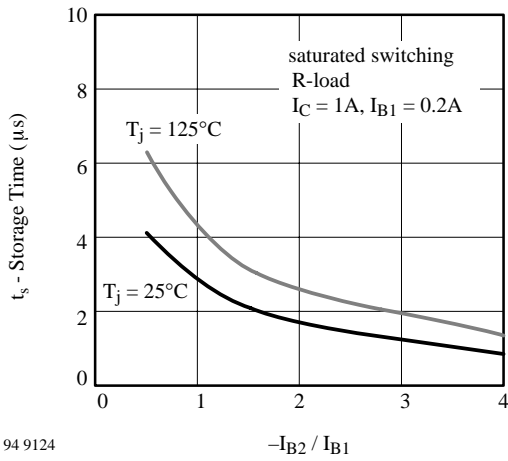
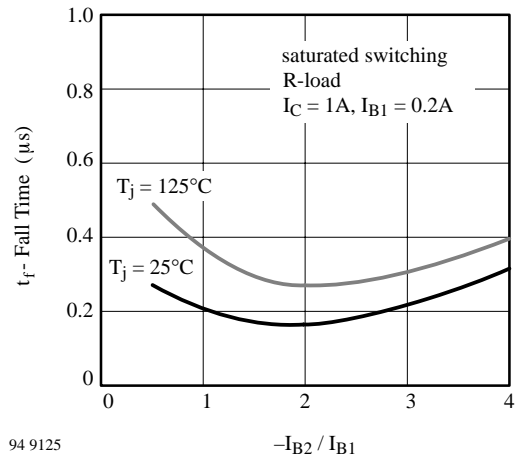
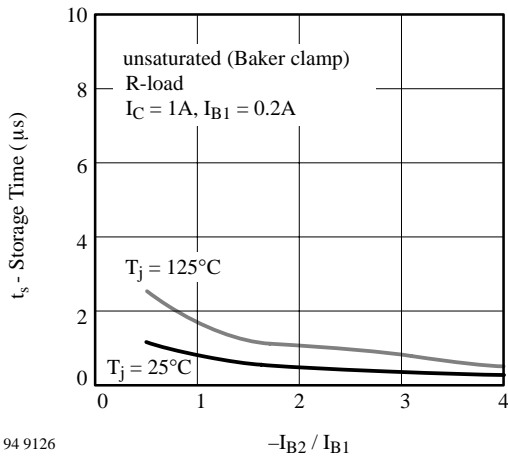
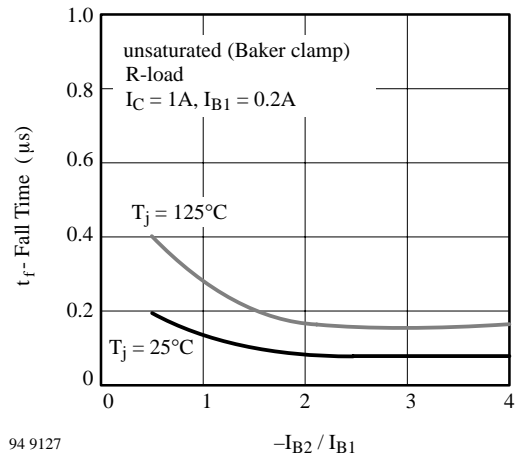
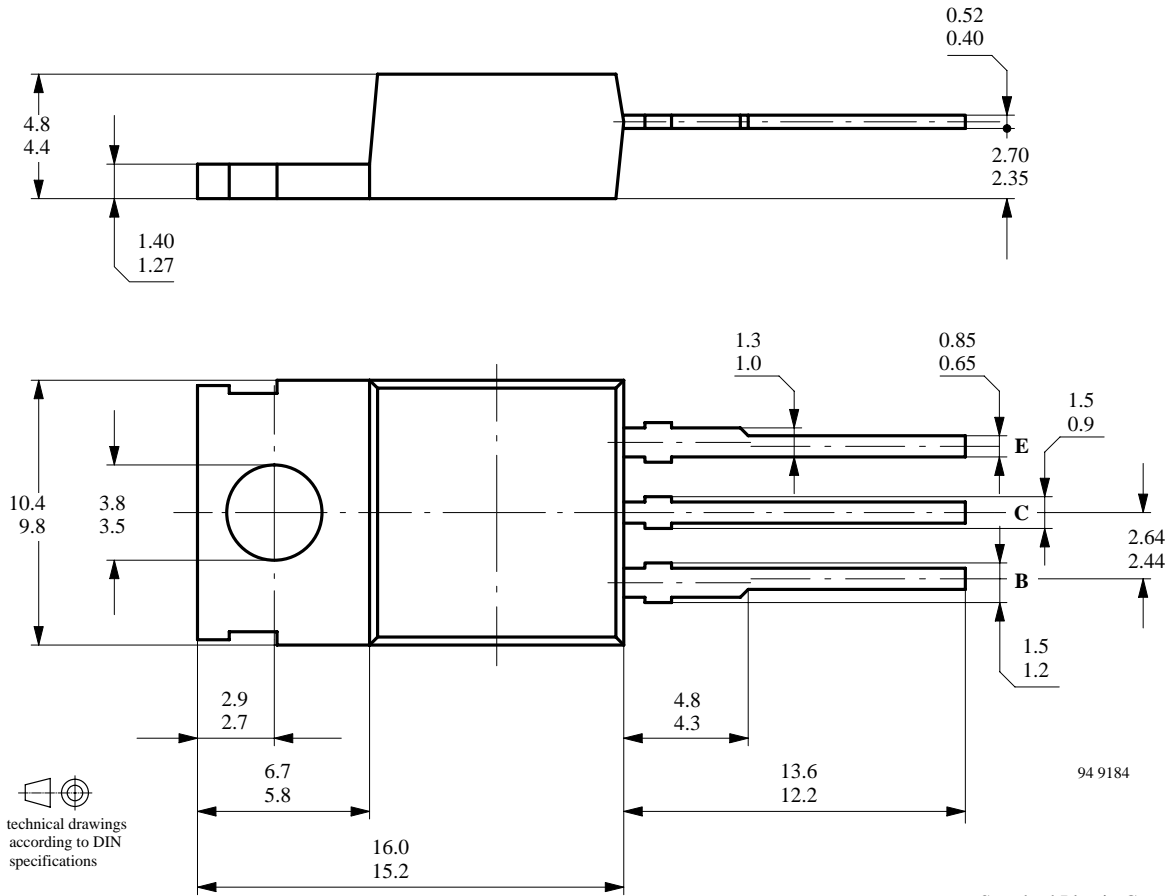

Figure 15. t_f vs. $-I_{B2}/I_{B1}$

 Figure 16. t_s vs. $-I_{B2}/I_{B1}$

 Figure 18. t_f vs. $-I_{B2}/I_{B1}$

 Figure 17. t_s vs. $-I_{B2}/I_{B1}$

 Figure 19. t_f vs. $-I_{B2}/I_{B1}$

Dimensions in mm



technical drawings according to DIN specifications

Collector connected with metallic surface

Standard Plastic Case
14A 3 DIN 41 869
JEDEC TO 220



Ozone Depleting Substances Policy Statement

It is the policy of **Vishay Semiconductor GmbH** to

1. Meet all present and future national and international statutory requirements.
2. Regularly and continuously improve the performance of our products, processes, distribution and operating systems with respect to their impact on the health and safety of our employees and the public, as well as their impact on the environment.

It is particular concern to control or eliminate releases of those substances into the atmosphere which are known as ozone depleting substances (ODSs).

The Montreal Protocol (1987) and its London Amendments (1990) intend to severely restrict the use of ODSs and forbid their use within the next ten years. Various national and international initiatives are pressing for an earlier ban on these substances.

Vishay Semiconductor GmbH has been able to use its policy of continuous improvements to eliminate the use of ODSs listed in the following documents.

1. Annex A, B and list of transitional substances of the Montreal Protocol and the London Amendments respectively
2. Class I and II ozone depleting substances in the Clean Air Act Amendments of 1990 by the Environmental Protection Agency (EPA) in the USA
3. Council Decision 88/540/EEC and 91/690/EEC Annex A, B and C (transitional substances) respectively.

Vishay Semiconductor GmbH can certify that our semiconductors are not manufactured with ozone depleting substances and do not contain such substances.

We reserve the right to make changes to improve technical design and may do so without further notice.

Parameters can vary in different applications. All operating parameters must be validated for each customer application by the customer. Should the buyer use Vishay-Telefunken products for any unintended or unauthorized application, the buyer shall indemnify Vishay-Telefunken against all claims, costs, damages, and expenses, arising out of, directly or indirectly, any claim of personal damage, injury or death associated with such unintended or unauthorized use.

Vishay Semiconductor GmbH, P.O.B. 3535, D-74025 Heilbronn, Germany
Telephone: 49 (0)7131 67 2831, Fax number: 49 (0)7131 67 2423