

# Preliminary Data Sheet

## Features

- Typical bandwidth of 100 MHz
- Absolute delay of 507 nsec
- Low group delay variation
- Ceramic Surface Mount Package (SMP)
- Small size

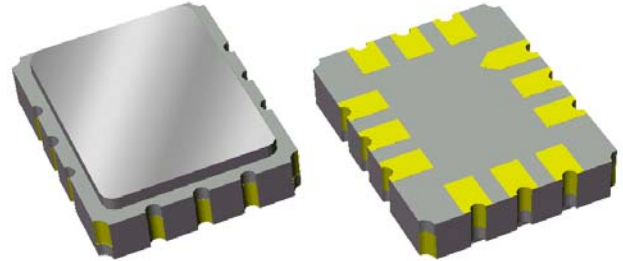

## Package

Surface Mount 7.01 x 5.51 x 1.63 mm

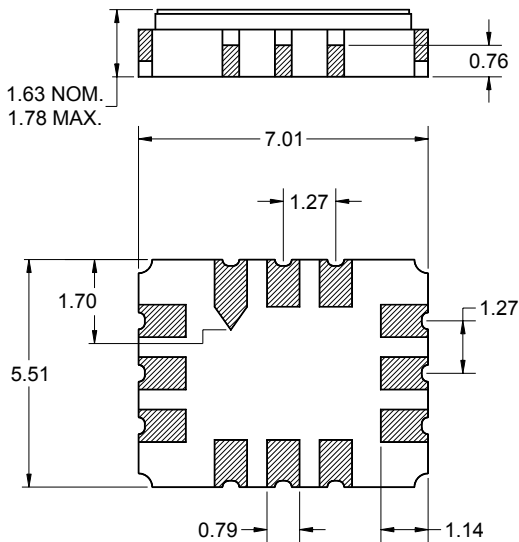

Dimensions shown are nominal in millimeters  
 All tolerances are  $\pm 0.15$ mm except overall  
 length and width  $\pm 0.13$ mm

Body:  $Al_2O_3$  ceramic  
 Lid: Kovar, Ni plated  
 Terminations: Au plating 0.5 - 1.0 $\mu$ m,  
 over a 2 - 6 $\mu$ m Ni plating

## Pin Configuration

Bottom View

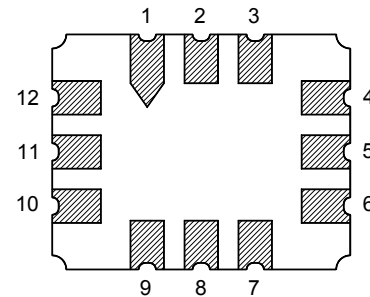

Pin No.	Description
4	Output
10,12	Balanced inputs
1,2,3,5,6	Case ground
7,8,9,11	Case ground

**Preliminary Data Sheet**
**Electrical Specifications <sup>(1)</sup>**
**Temperature Range: <sup>(2)</sup> -35 to +85 °C**

Parameter <sup>(3)</sup>	Minimum	Typical	Maximum	Unit
<b>Center Frequency</b>	-	2140.0	-	MHz
<b>Minimum Insertion Loss</b>				
+25 °C	-	25	26.2	dB
-35 to +85 °C	-	25	29	dB
<b>Lower 1dB Bandedge</b>	-	2097	2110	MHz
<b>Upper 1dB Bandedge</b>	2170	2202	-	MHz
<b>Amplitude Variation</b>				
2130 - 2150 MHz	-	0.22	0.8	dB p-p
2110 - 2170 MHz	-	0.56	1.2	dB p-p
<b>Phase Linearity</b>				
2130 - 2150 MHz	-	1.30	7.0	degree
2110 - 2170 MHz	-	2.10	8.0	degree
<b>Average Absolute Delay</b>	502	507	512	nsec
<b>Group Delay Variation</b>	-	7.0	40	nsec
<b>Input VSWR</b>				
2130 - 2150 MHz	-	1.65:1	5.0:1	-
<b>Output VSWR</b>				
2130 - 2150 MHz	-	2.05:1	5.0:1	-
<b>Source Impedance <sup>(4) (5)</sup></b>	-	50	-	Ω
<b>Load Impedance <sup>(5)</sup></b>	-	50	-	Ω

**Notes:**

1. All specifications are based on the test circuit shown below
2. In production, devices will be tested at room temperature to a guardbanded specification to ensure electrical compliance over temperature
3. Electrical margin has been built into the design to account for the variations due to temperature drift and manufacturing tolerances
4. 50Ω with balun to 100Ω on filter
5. This is the optimum impedance in order to achieve the performance shown

**Test Circuit:**

Actual matching values may vary due to PCB layout and parasitics

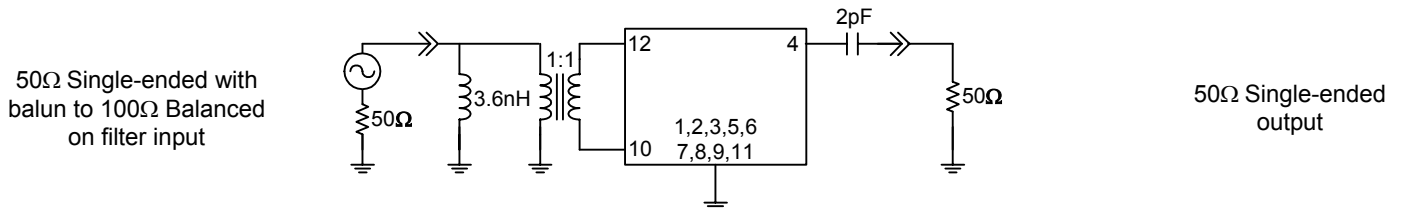

**Preliminary Data Sheet**

**Typical Performance (at +25°C)**

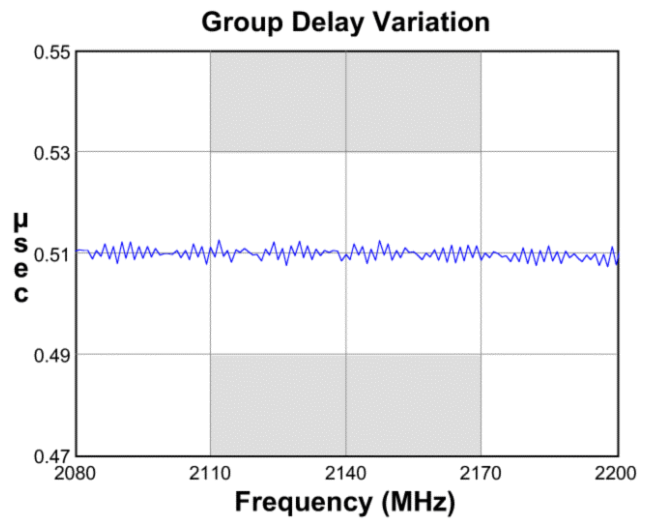
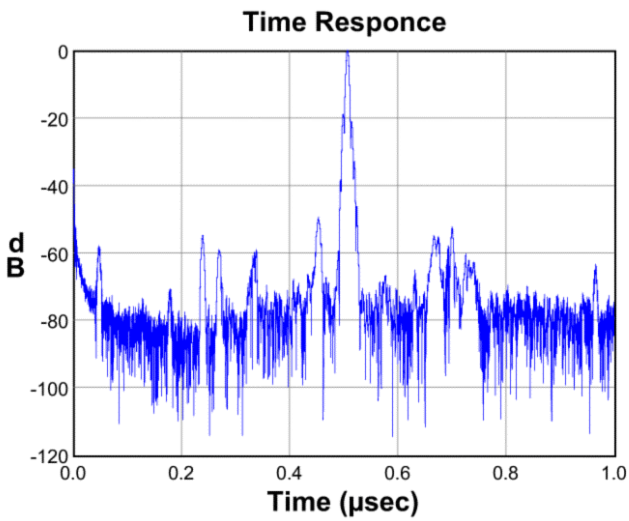
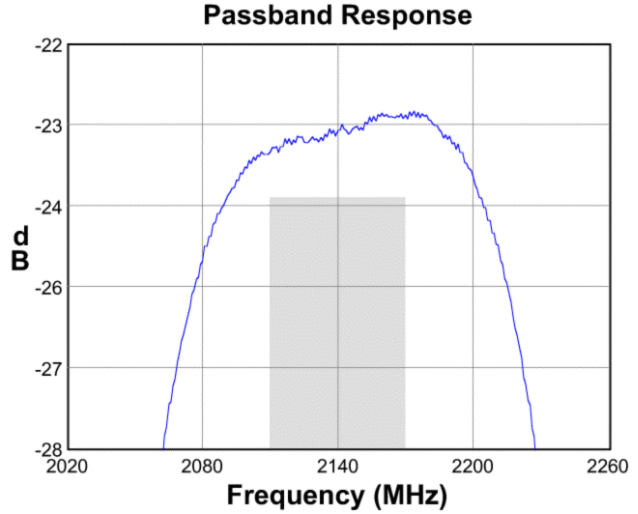
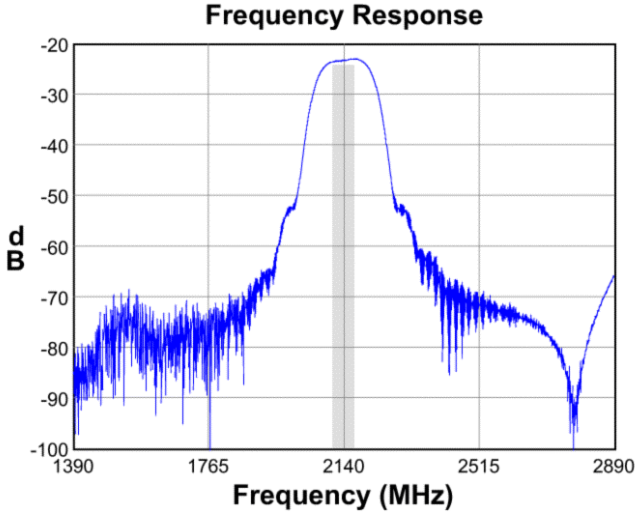

**Input Smith Chart**

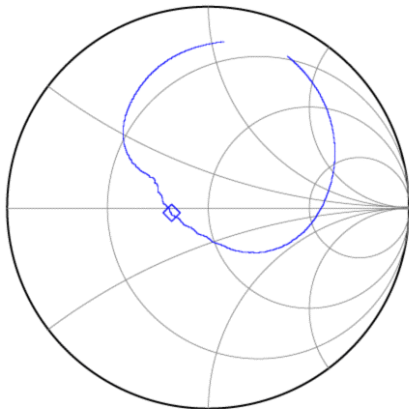

**Output Smith Chart**

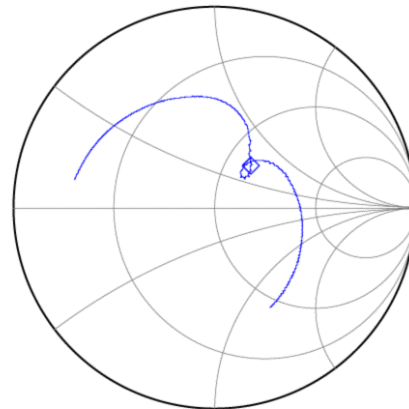

**Preliminary Data Sheet**

**Matching Schematics**

Actual matching values may vary due to PCB layout and parasitics

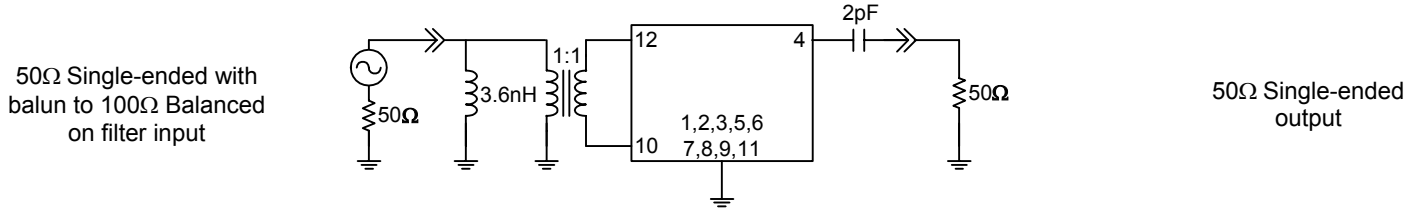

**Marking**

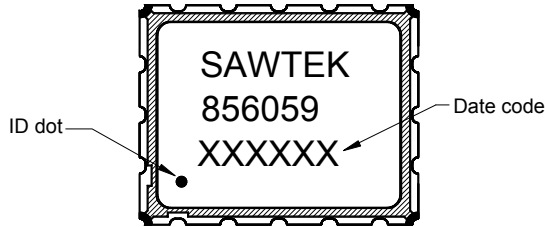

The date code consists of: day of the current year (Julian, 3 digits), last digit of the year (1 digit) and hour (2 digits)

**PCB Footprint**

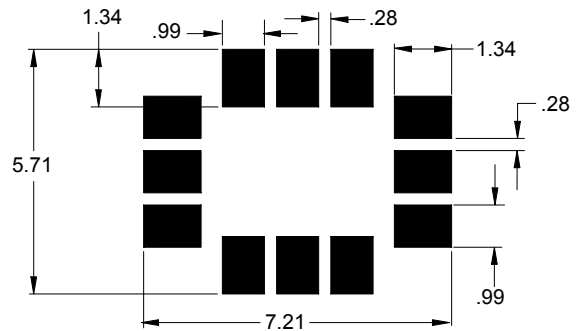

This footprint represents a recommendation only  
Dimensions shown are nominal in millimeters

**Tape and Reel**

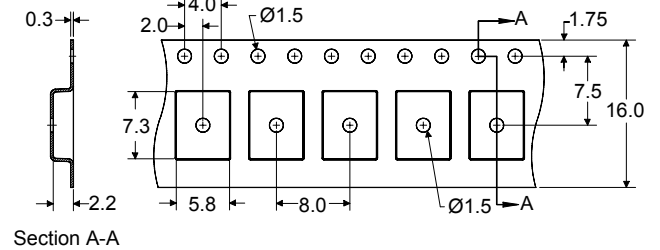
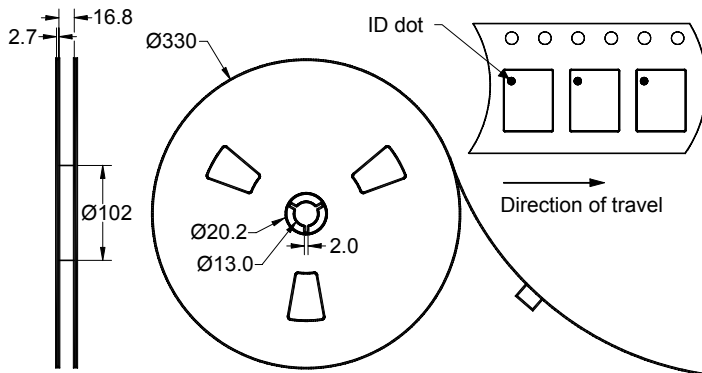

Dimensions shown are nominal in millimeters  
Packaging quantity: 3000 units/reel

# Preliminary Data Sheet

## Maximum Ratings

Parameter	Symbol	Minimum	Maximum	Unit
Operating Temperature Range	T	-35	+85	°C
Storage Temperature Range	T <sub>stg</sub>	-40	+85	°C

### Warnings

- Electrostatic Sensitive Device (ESD) 
- Avoid ultrasonic exposure

## Links to Additional Technical Information

[PCB Layout Tips](#)

[Qualification Flowchart](#)

[Soldering Profile](#)

[S-Parameters](#)

[Other Technical Information](#)

Sawtek's liability is limited only to the Surface Acoustic Wave (SAW) component(s) described in this data sheet. Sawtek does not accept any liability for applications, processes, circuits or assemblies which are implemented using any Sawtek component described in this data sheet.

## Contact Information



PO Box 609501  
Orlando, FL 32860-9501  
USA

Phone: +1 (407) 886-8860  
Fax: +1 (407) 886-7061  
Email: [custservice@sawtek.com](mailto:custservice@sawtek.com)  
Web: [www.sawtek.com](http://www.sawtek.com)

Or contact one of our worldwide network of [sales offices](#), [representatives](#) or [distributors](#)