

V_{RSM}	=	3000 V
$I_{F(AV)M}$	=	1285 A
$I_{F(RMS)}$	=	2019 A
I_{FSM}	=	15×10^3 A
V_{F0}	=	0.933 V
r_F	=	0.242 mW

Rectifier Diode

5SDD 11D2800

Doc. No. 5SYA1166-00 Okt. 03

- Very low on-state losses
- Optimum power handling capability

Blocking

*Maximum rated values*¹⁾

Parameter	Symbol	Conditions	Value	Unit
Repetitive peak reverse voltage	V_{RRM}	$f = 50$ Hz, $t_p = 10$ ms, $T_j = -40 \dots 160^\circ\text{C}$	2800	V
Non - repetitive peak reverse voltage	V_{RSM}	$f = 5$ Hz, $t_p = 10$ ms, $T_j = -40 \dots 160^\circ\text{C}$	3000	V

Characteristic values

Parameter	Symbol	Conditions	min	typ	max	Unit
Max. (reverse) leakage current	I_{RRM}	V_{RRM} , $T_j = 160^\circ\text{C}$			30	mA

Mechanical data

*Maximum rated values*¹⁾

Parameter	Symbol	Conditions	min	typ	max	Unit
Mounting force	F_M		8	10	12	kN
Acceleration	a	Device unclamped			50	m/s^2
Acceleration	a	Device clamped			100	m/s^2

Characteristic values

Parameter	Symbol	Conditions	min	typ	max	Unit
Weight	m			0.3		kg
Housing thickness	H	$F_M = 10$ kN, $T_a = 25^\circ\text{C}$	25.5		26.5	mm
Surface creepage distance	D_S		33			mm
Air strike distance	D_a		18			mm

1) Maximum rated values indicate limits beyond which damage to the device may occur

ABB Switzerland Ltd, Semiconductors reserves the right to change specifications without notice.



On-state

Maximum rated values ¹⁾

Parameter	Symbol	Conditions	min	typ	max	Unit
Max. average on-state current	$I_{F(AV)M}$	50 Hz, Half sine wave, $T_C = 85\text{ °C}$			1285	A
Max. RMS on-state current	$I_{F(RMS)}$				2019	A
Max. peak non-repetitive surge current	I_{FSM}	$t_p = 10\text{ ms}$, $T_j = 160\text{ °C}$, $V_R = 0\text{ V}$			15×10^3	A
Limiting load integral	I^2t				1.125×10^6	A^2s
Max. peak non-repetitive surge current	I_{FSM}	$t_p = 8.3\text{ ms}$, $T_j = 160\text{ °C}$, $V_R = 0\text{ V}$			16×10^3	A
Limiting load integral	I^2t				1.066×10^6	A^2s

Characteristic values

Parameter	Symbol	Conditions	min	typ	max	Unit
On-state voltage	V_F	$I_F = 1500\text{ A}$, $T_j = 160\text{ °C}$			1.3	V
Threshold voltage	$V_{(T0)}$	$T_j = 160\text{ °C}$ $I_T = 1500...4500\text{ A}$			0.933	V
Slope resistance	r_T				0.242	$m\Omega$

Switching

Characteristic values

Parameter	Symbol	Conditions	min	typ	max	Unit
Recovery charge	Q_{rr}	$di_F/dt = -30\text{ A}/\mu\text{s}$, $V_R = 100\text{ V}$ $I_{FRM} = 1000\text{ A}$, $T_j = 160\text{ °C}$		2200	3000	μAs

Thermal

Maximum rated values ¹⁾

Parameter	Symbol	Conditions	min	typ	max	Unit
Operating junction temperature range	T_{vj}		-40		160	°C
Storage temperature range	T_{stg}		-40		175	°C

Characteristic values

Parameter	Symbol	Conditions	min	typ	max	Unit
Thermal resistance junction to case	$R_{th(j-c)}$	Double-side cooled $F_m = 8...12$ kN			32	K/kW
	$R_{th(j-c)A}$	Anode-side cooled $F_m = 8...12$ kN			50	K/kW
	$R_{th(j-c)C}$	Cathode-side cooled $F_m = 8...12$ kN			88	K/kW
Thermal resistance case to heatsink	$R_{th(c-h)}$	Double-side cooled $F_m = 8...12$ kN			8	K/kW
	$R_{th(c-h)}$	Single-side cooled $F_m = 8...12$ kN			16	K/kW

Analytical function for transient thermal impedance:

$$Z_{th(j-c)}(t) = \sum_{i=1}^n R_{th i} (1 - e^{-t/t_i})$$

i	1	2	3	4
$R_{th i}$ (K/kW)	11.600	10.110	7.870	2.410
τ_i (s)	0.7033	0.2185	0.0588	0.0042

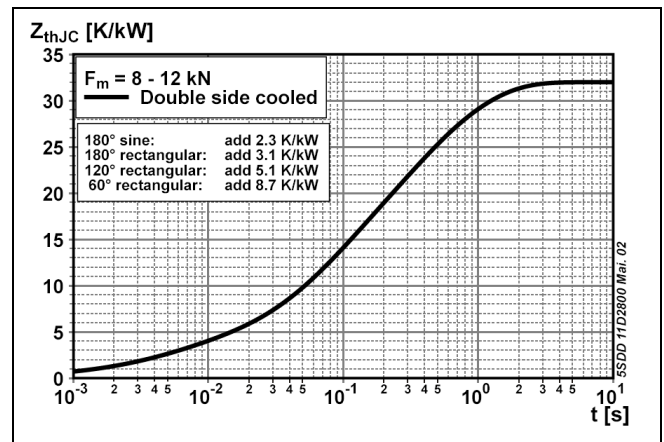

Fig. 1 Transient thermal impedance junction-to-case.

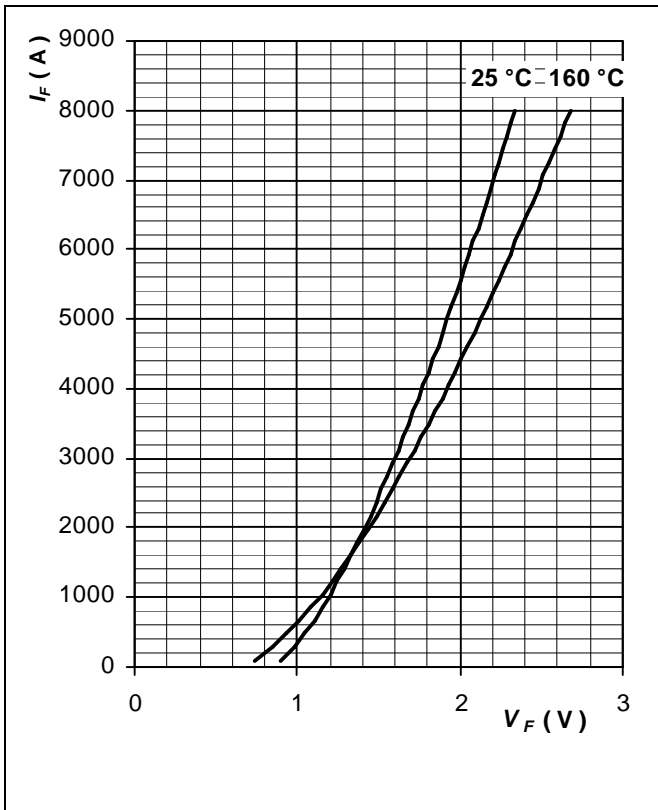

Fig. 2 Max. on-state characteristics.

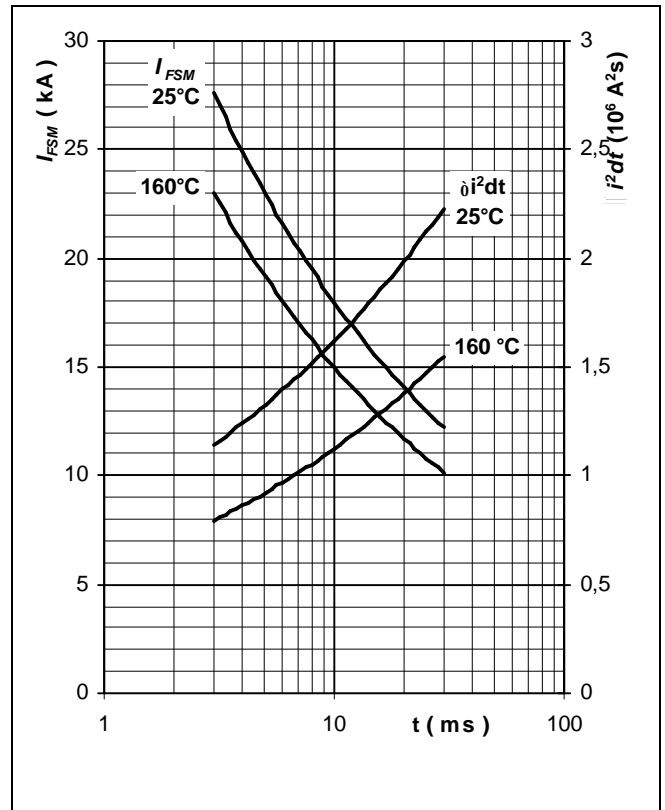

Fig. 3 Surge forward current vs. pulse length. Half sine wave, single pulse, $V_R = 0$ V

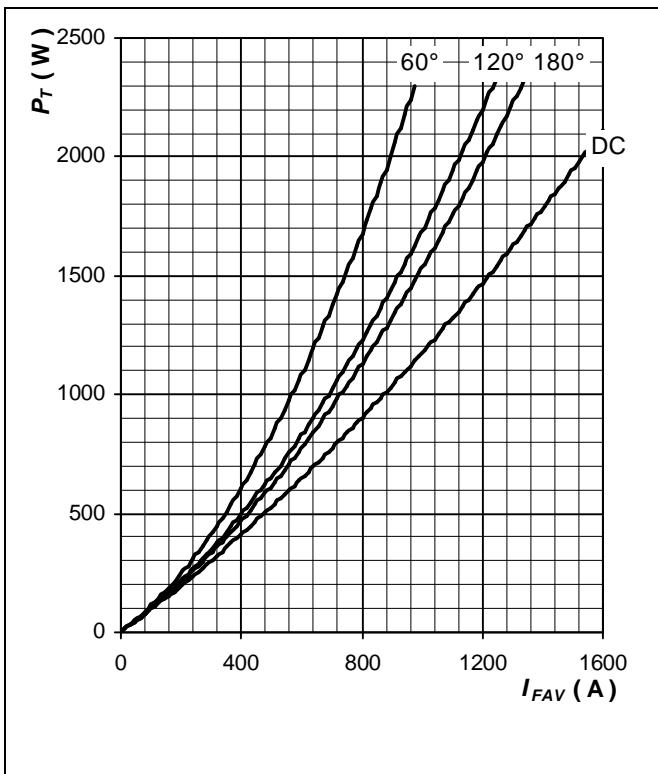

Fig. 4 Forward power loss vs. average forward current, sine waveform, $f = 50$ Hz

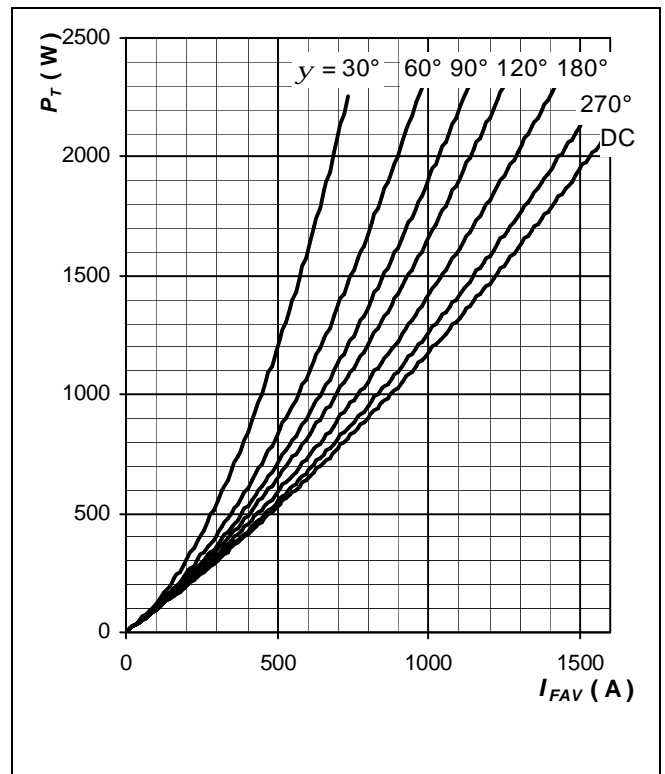

Fig. 5 Forward power loss vs. average forward current, square waveform, $f = 50$ Hz

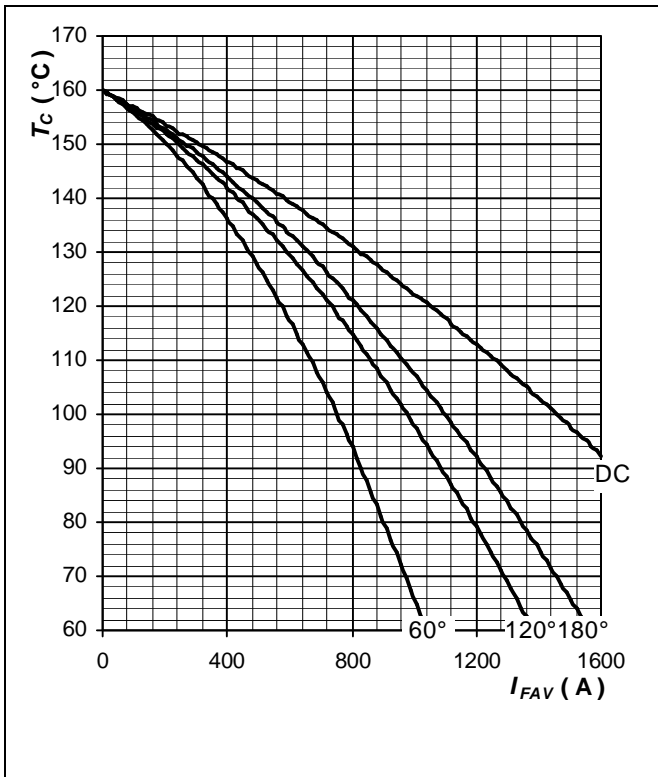

Fig. 6 Max. case temperature vs aver. forward current, sine waveform, $f = 50$ Hz

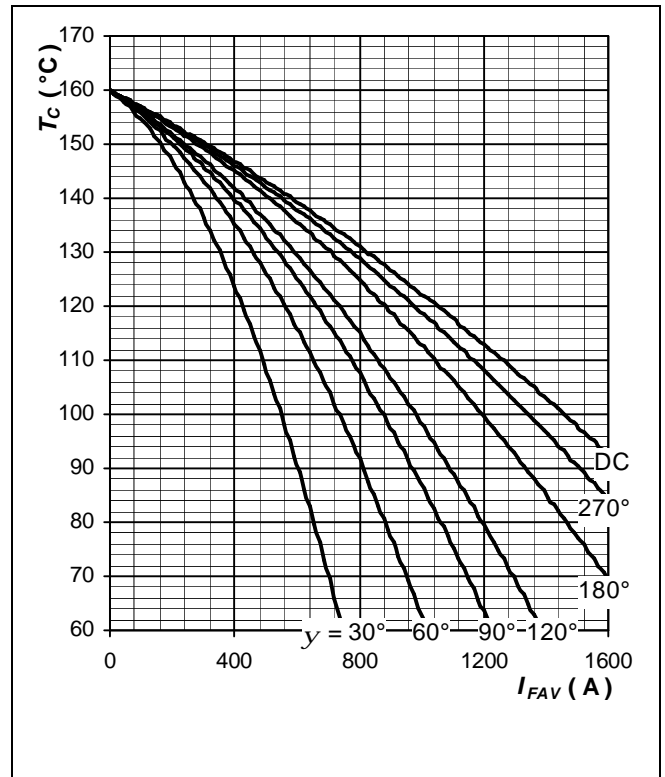

Fig. 7 Max. case temperature vs aver. forward current, square waveform, $f = 50$ Hz

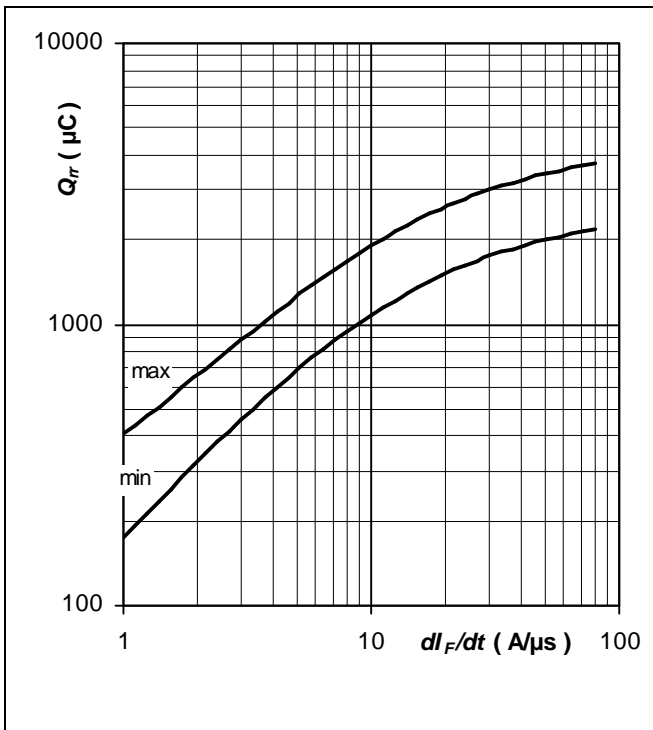

Fig. 8 Reverse recovery charge vs. di_F/dt , $I_F = 1000$ A; $T_j = T_{jmax}$, limit values

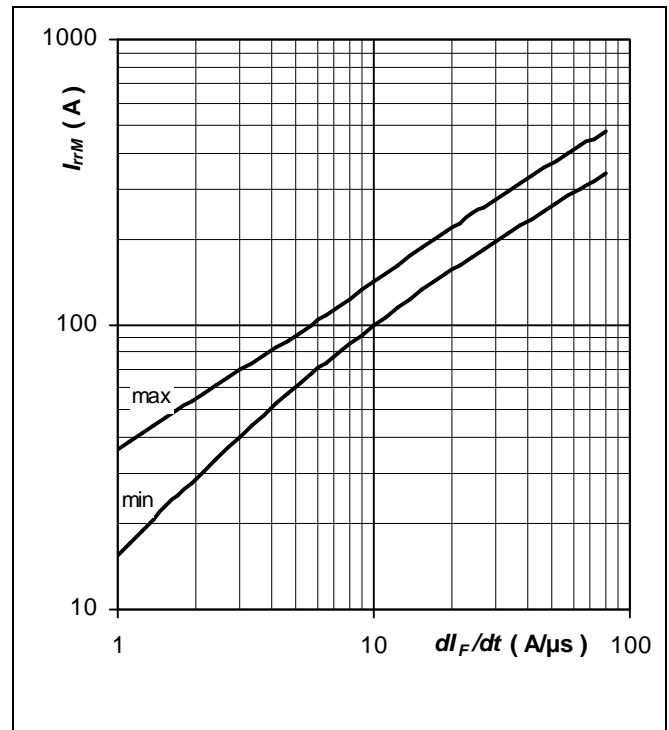

Fig. 9 Peak reverse recovery current vs. di_F/dt , $I_F = 1000$ A; $T_j = T_{jmax}$, limit values

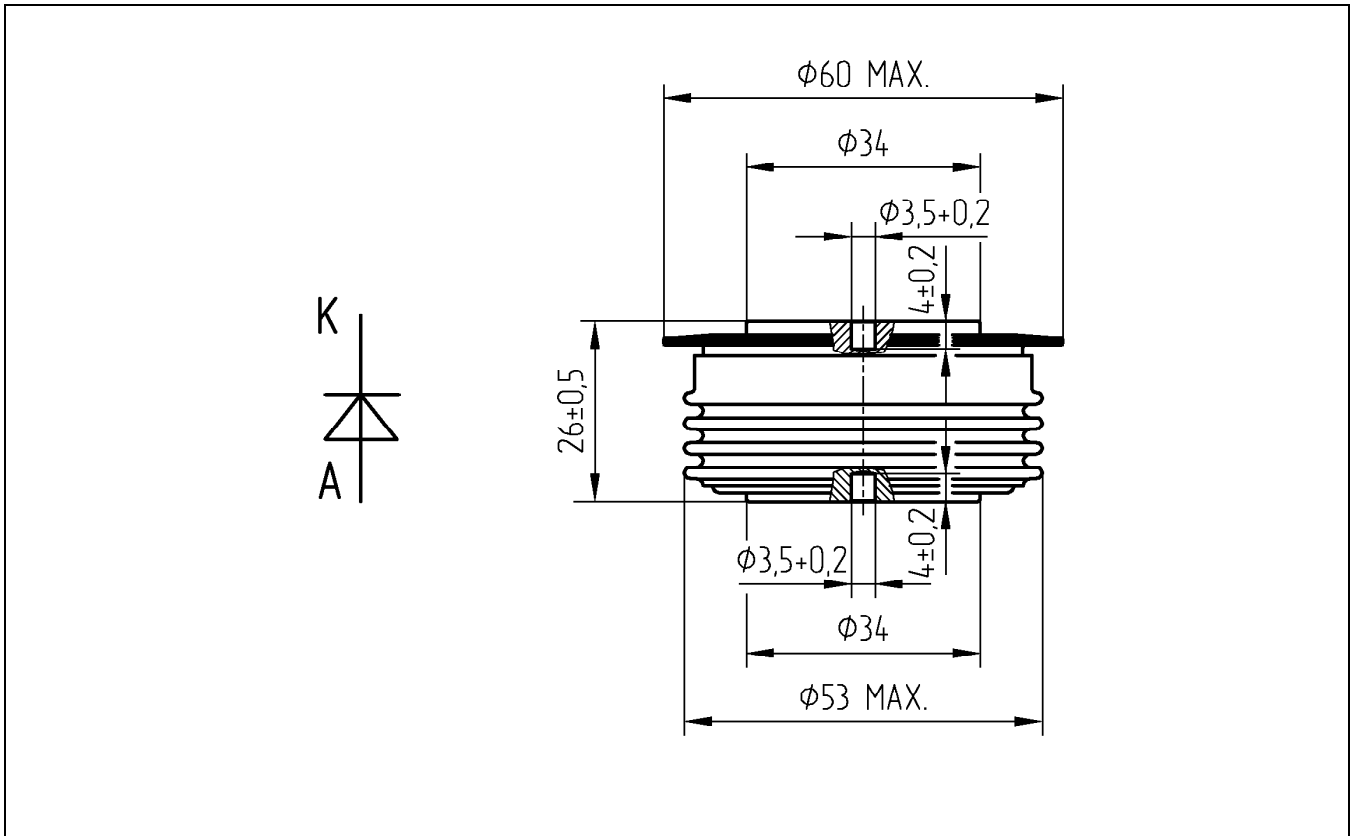

Fig. 10 Outline drawing. All dimensions are in millimeters and represent nominal values unless stated otherwise.

Related application notes:

Doc. Nr	Titel
5SYA 2020	Design of RC-Snubbers for Phase Control Applications
5SYA 2029	Designing Large Rectifiers with High Power Diodes
5SYA 2036	Recommendations regarding mechanical clamping of Press Pack High Power Semiconductors

Please refer to <http://www.abb.com/semiconductors> for actual versions.

ABB Switzerland Ltd, Semiconductors reserves the right to change specifications without notice.

ABB

ABB Switzerland Ltd
Semiconductors
 Fabrikstrasse 3
 CH-5600 Lenzburg, Switzerland

Doc. No. 5SYA1166-00 Okt. 03

Telephone +41 (0)58 586 1419
 Fax +41 (0)58 586 1306
 Email abbsem@ch.abb.com
 Internet www.abb.com/semiconductors