

SHINDENGEN

Darlington Transistor

2SD1794
(TP10L20)

10A NPN

OUTLINE DIMENSIONS

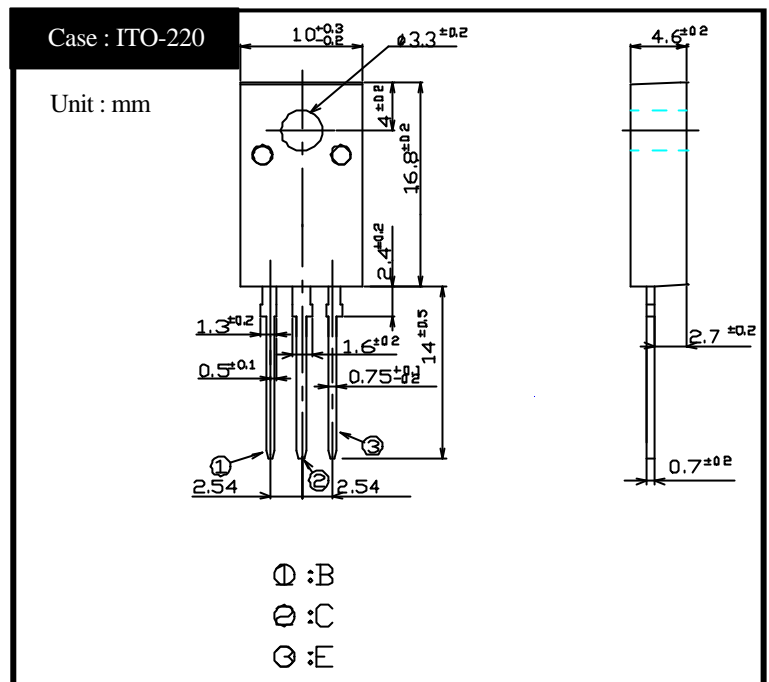

RATINGS

Absolute Maximum Ratings

Item	Symbol	Conditions	Ratings	Unit
Storage Temperature	T _{stg}		-55 ~ +150	
Junction Temperature	T _j		+150	
Collector to Base Voltage	V _{CBO}		200	V
Collector to Emitter Voltage	V _{CEO}		200	V
Emitter to Base Voltage	V _{EBO}		7	V
Collector Current DC	I _C		10	A
Collector Current Peak	I _{CP}		15	A
Base Current DC	I _B		0.5	A
Base Current Peak	I _{BP}		1.0	A
Total Transistor Dissipation	P _T	T _C = 25	50	W
Dielectric Strength	V _{dis}	Terminals to case AC 1 minute	2	kV
Mounting Torque	TOR	(Recommended torque : 0.3N·m)	0.5	N·m

Electrical Characteristics (T_c=25)

Item	Symbol	Conditions	Ratings	Unit
Collector Cutoff Current	I _{CBO}	V _{CB} = 200V	Max 0.1	mA
	I _{CEO}	V _{CE} = 200V	Max 0.1	
Emitter Cutoff Current	I _{EBO}	V _{EB} = 7V	Max 5	mA
DC Current Gain	h _{FE}	V _{CE} = 3V, I _C = 5A	Min 1,500	
			Max 30,000	
Collector to Emitter Saturation Voltage	V _{CE(sat)}	I _C = 5A	Max 1.5	V
Base to Emitter Saturation Voltage	V _{BE(sat)}	I _B = 10mA	Max 2.0	V
Thermal Resistance	θ _{JC}	Junction to case	Max 2.5	/W
Transition Frequency	f _T	V _{CE} = 10V, I _C = 1A	TYP 20	MHz
Turn on Time	t _{on}	I _C = 5A I _{B1} = I _{B2} = 10mA R _L = 6 V _{BB2} = 4V	Max 2	μs
Storage Time	t _s		Max 12	
Fall Time	t _f		Max 5	

2SD1794

$h_{FE} - I_C$

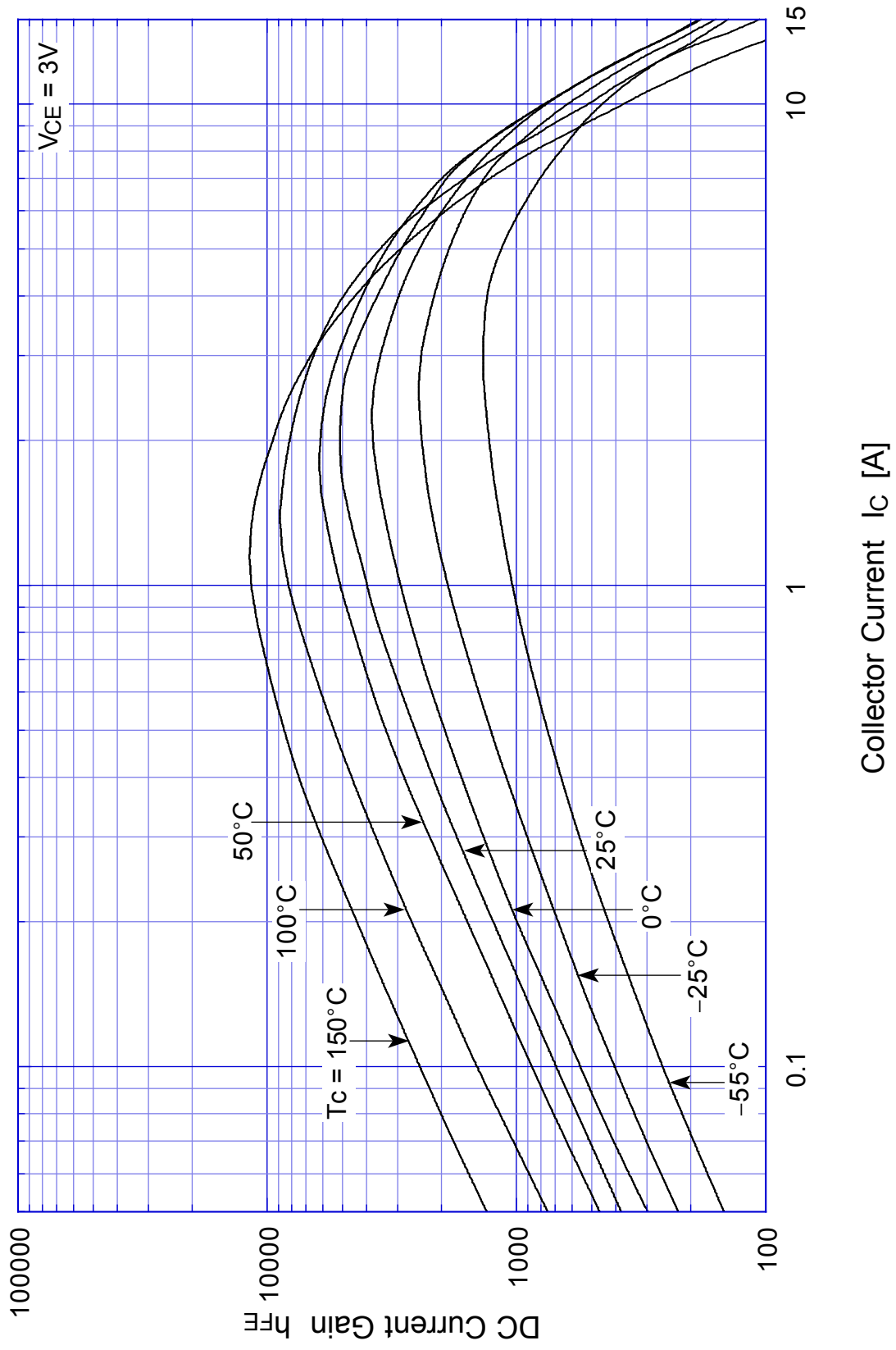

2SD1794 Saturation Voltage

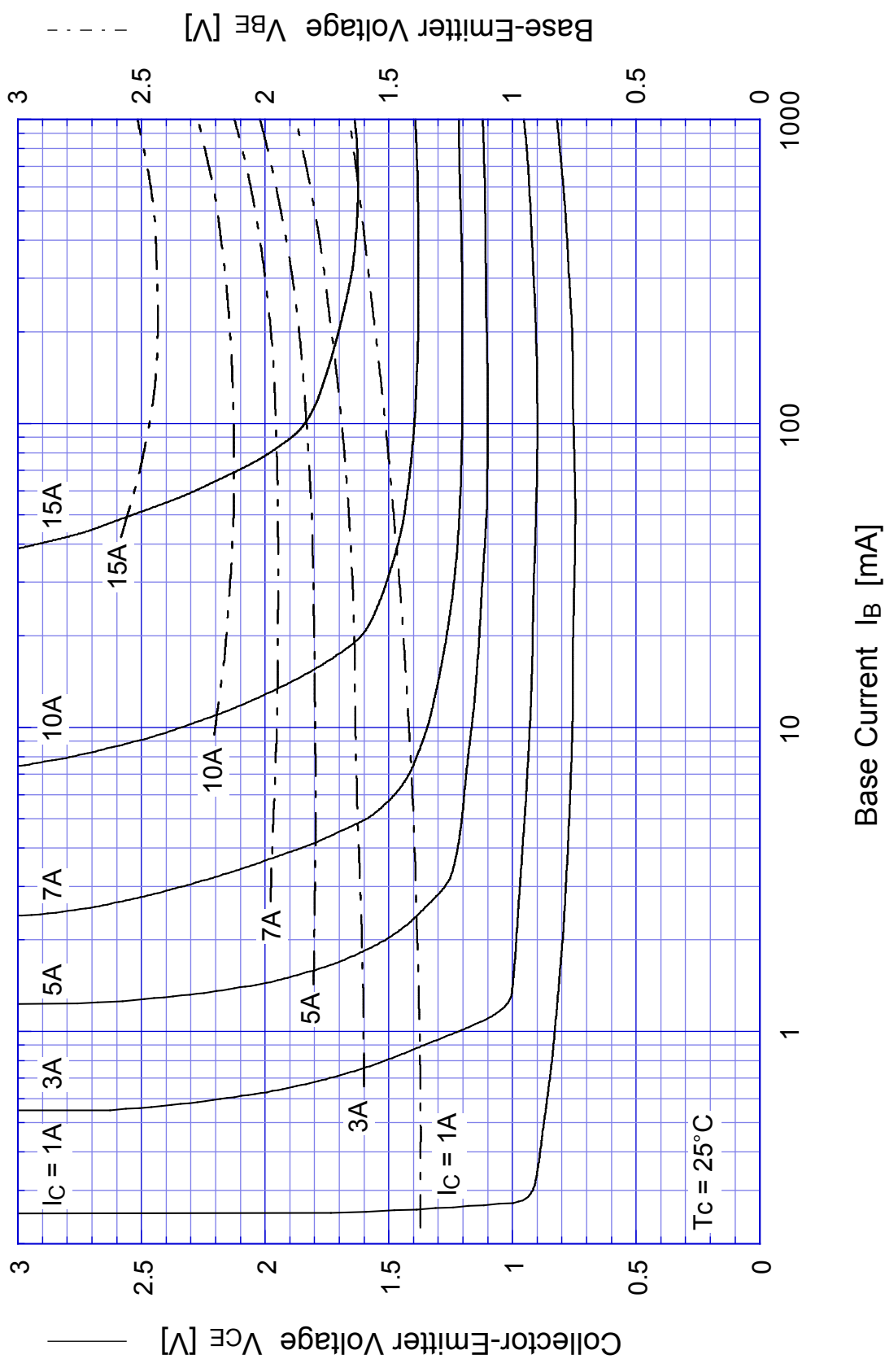

2SD1794

Switching Time - I_C

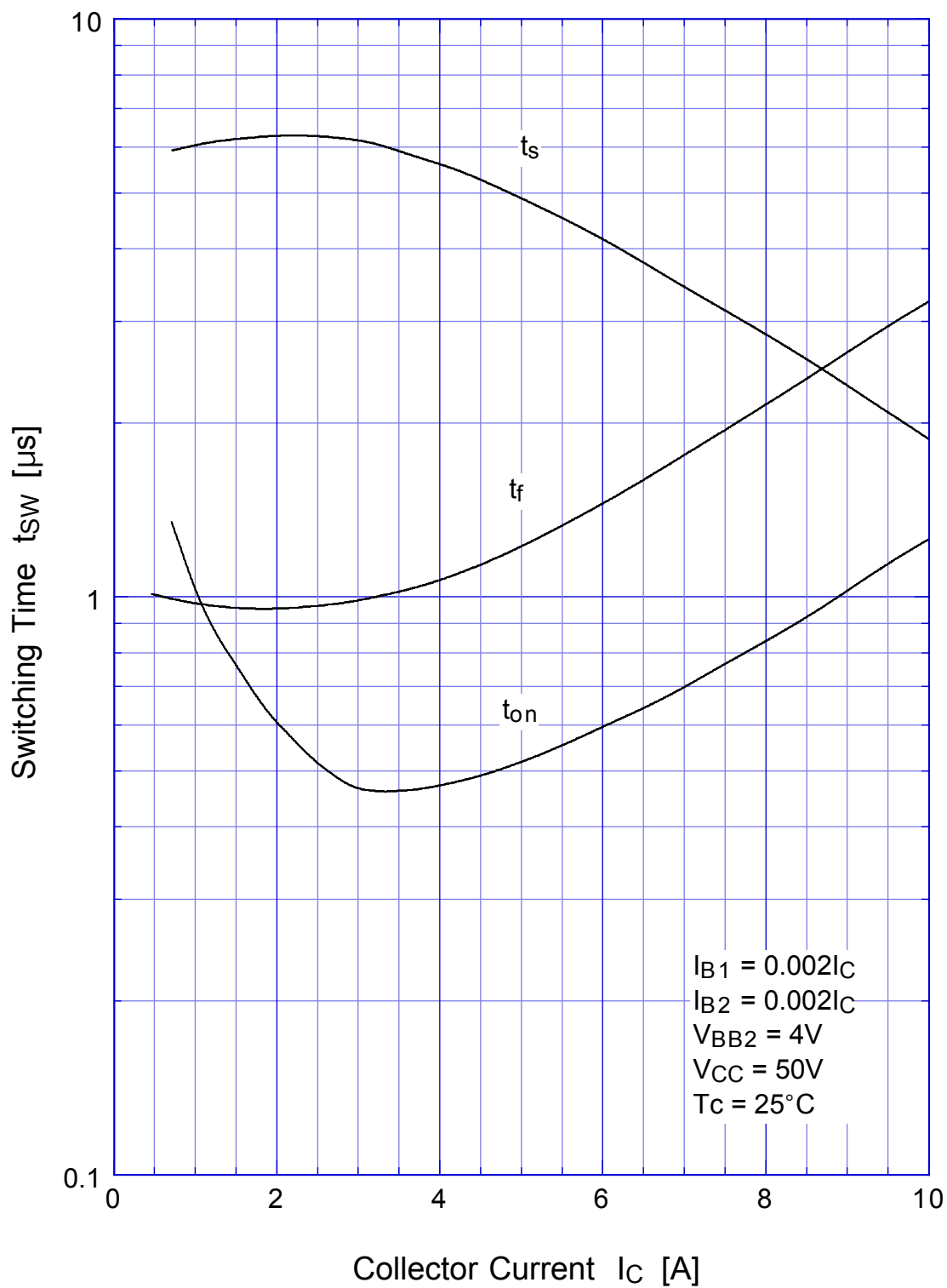

2SD1794

Switching Time - Tc

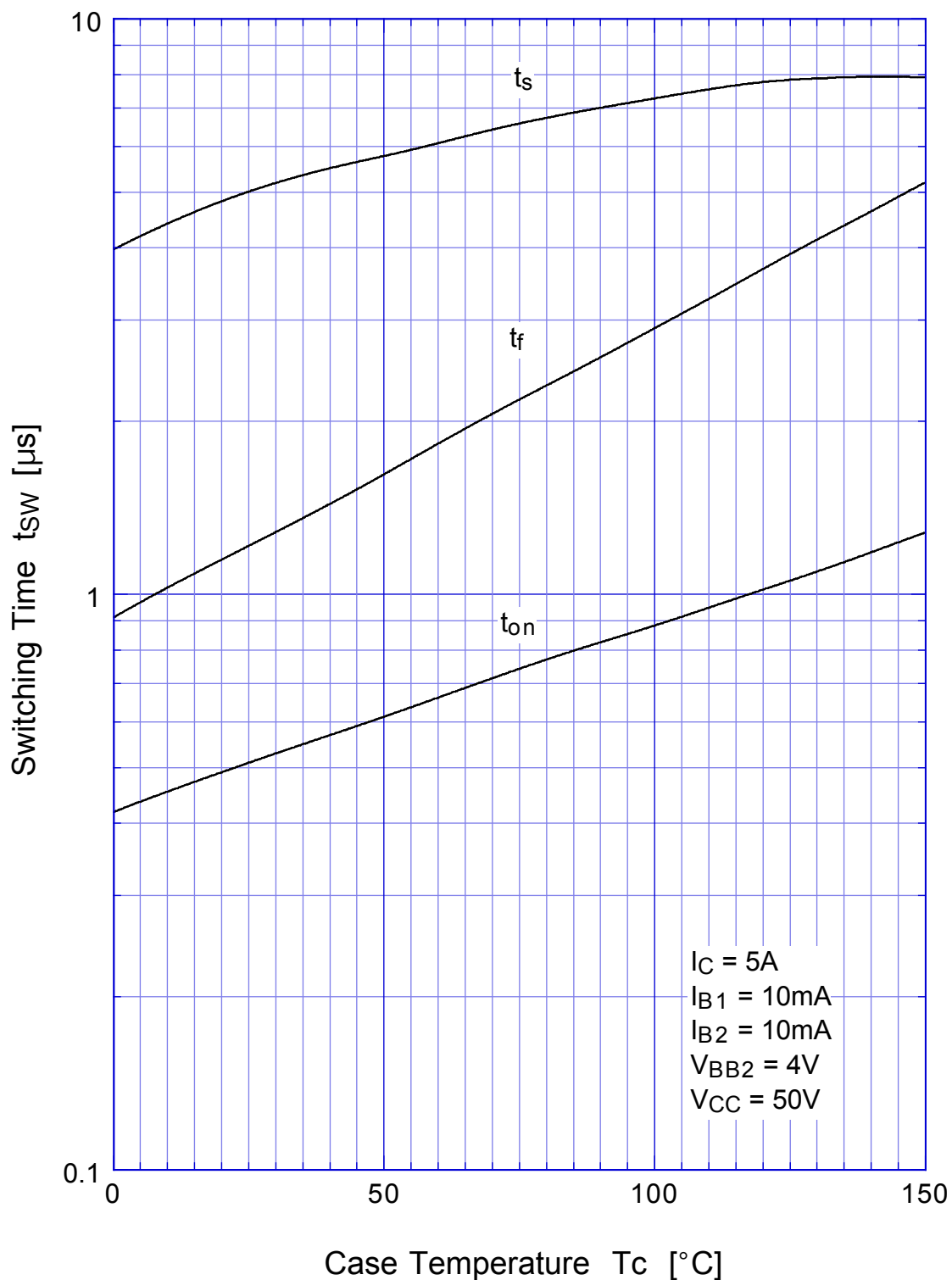

2SD1794 Transient Thermal Impedance

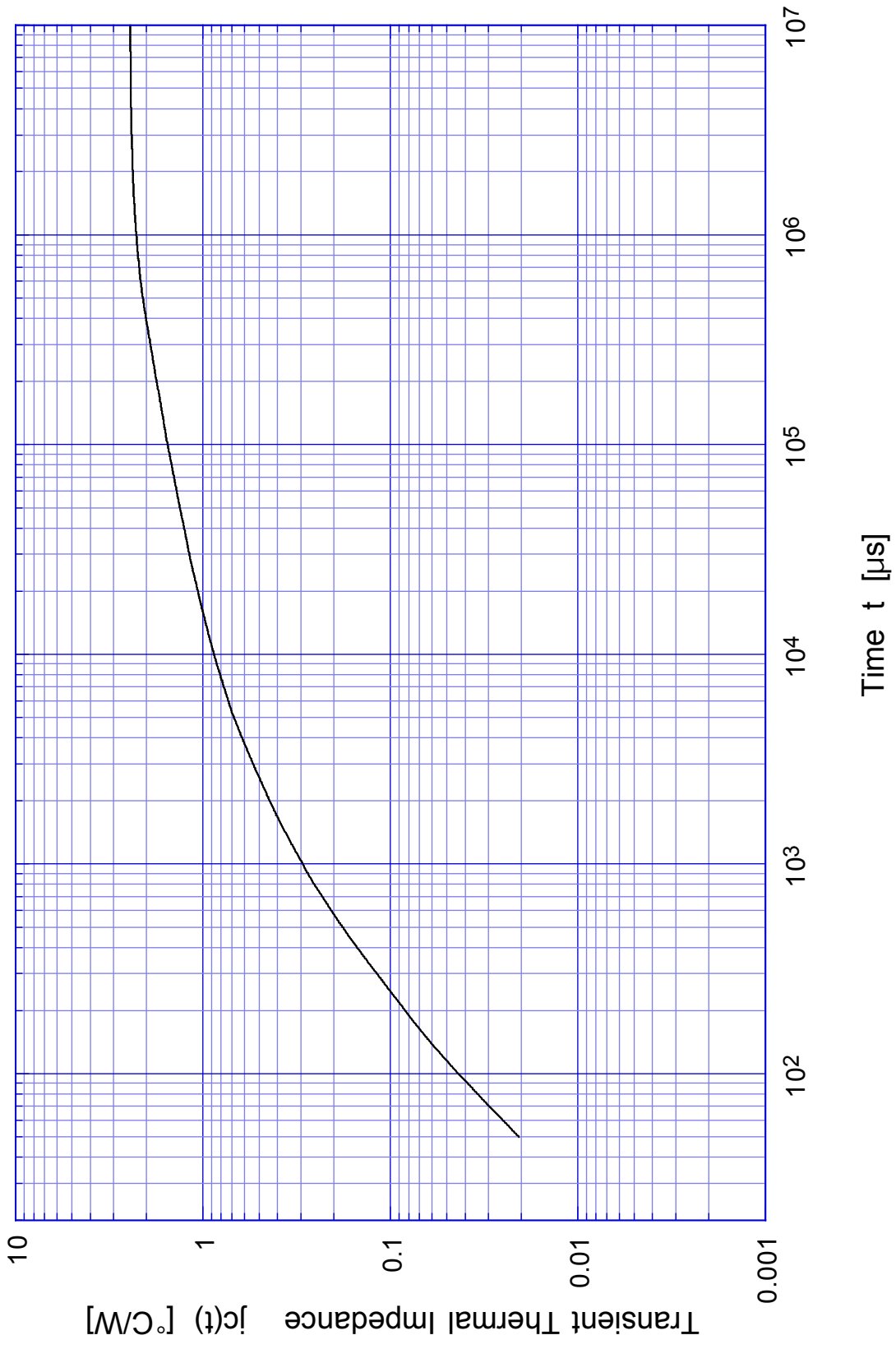

2SD1794

Forward Bias SOA

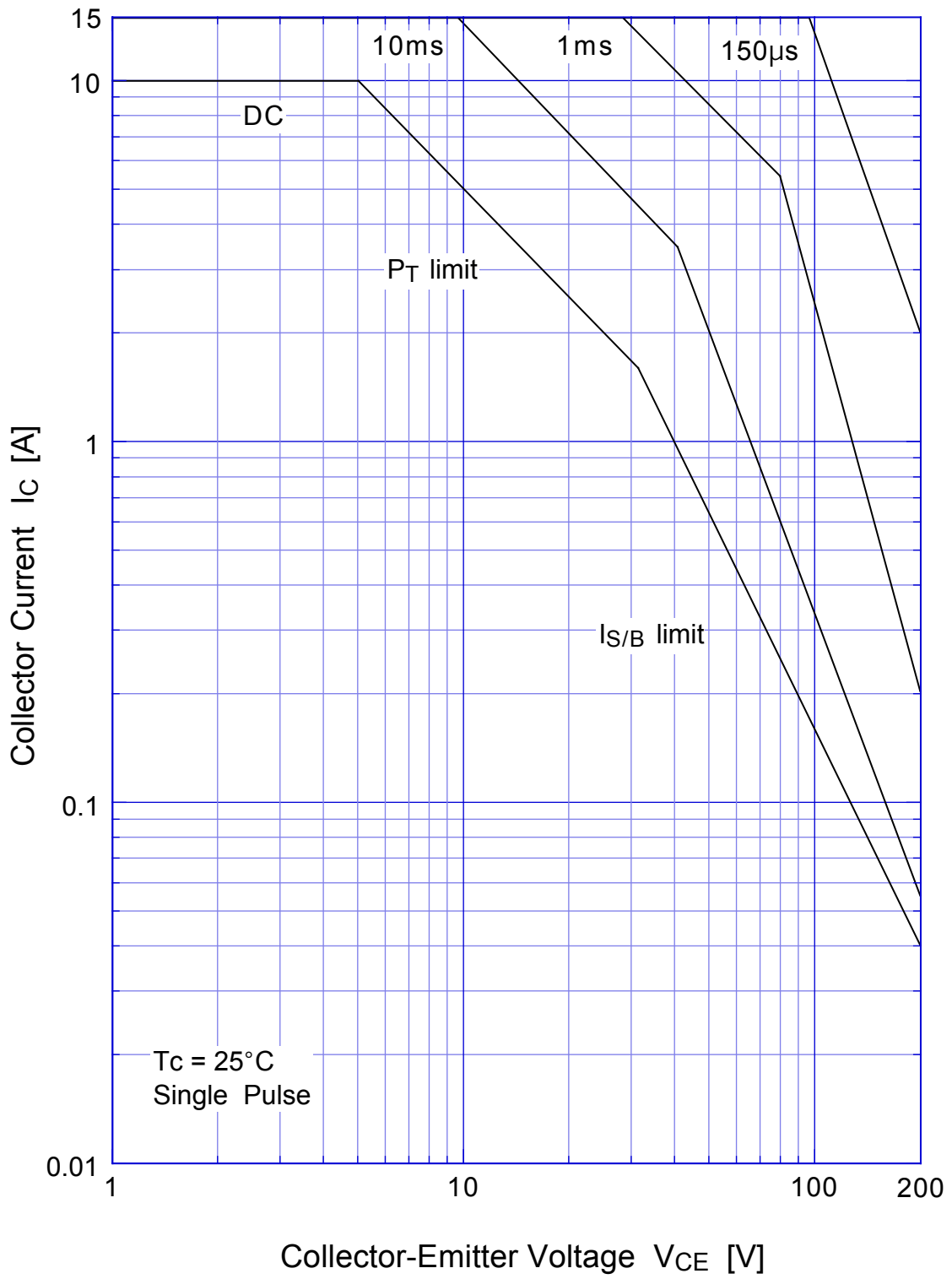

2SD1794 Collector Current Derating

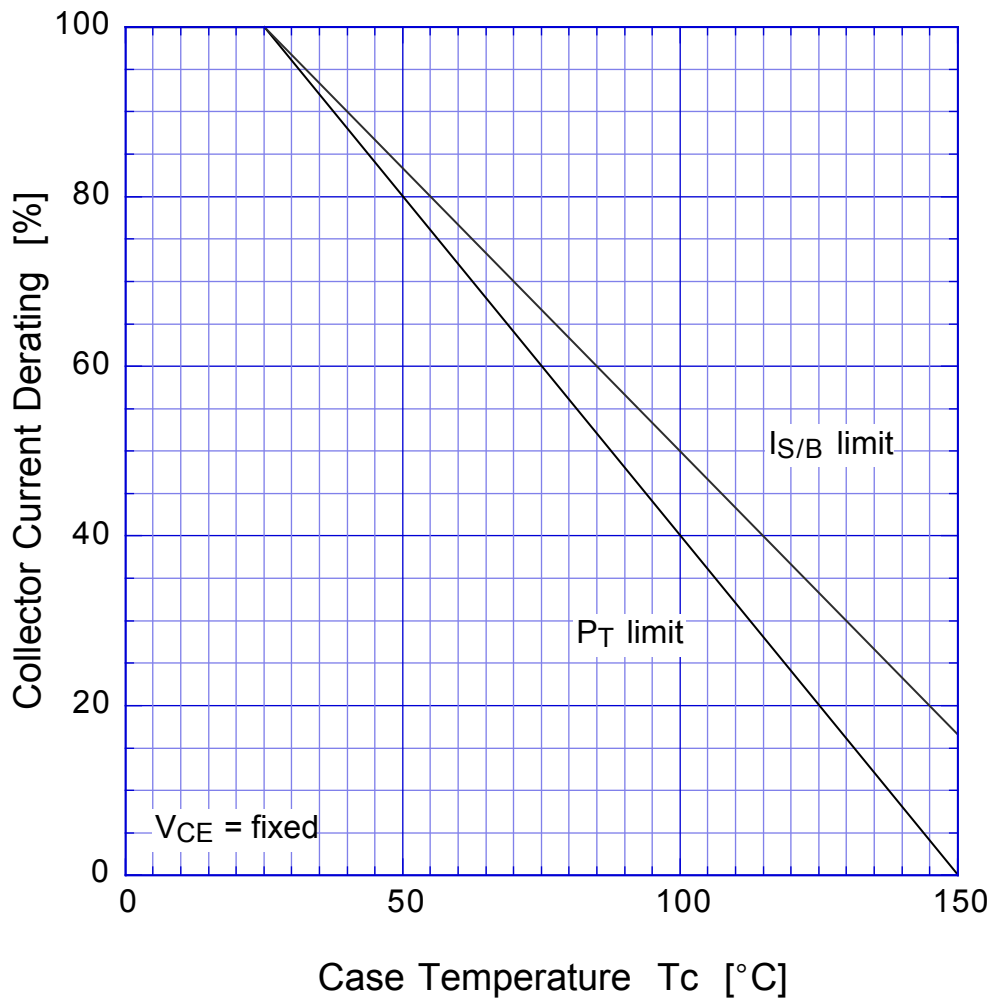

2SD1794

Reverse Bias SOA

