

## IGBT MODULE ( F series)

### ■ Features

- Low Saturation Voltage
- Voltage Drive
- Variety of Power Capacity Series

### ■ Applications

- Inverter for Motor Drive
- AC and DC Servo Drive Amplifier
- Uninterruptible Power Supply
- Industrial Machines, such as Welding Machines

### ■ Maximum Ratings and Characteristics

#### ● Absolute Maximum Ratings

Items	Symbols	Ratings	Units
Collector-Emitter Voltage	$V_{CES}$	600	V
Gate-Emitter Voltage	$V_{GES}$	$\pm 20$	V
Collector Current	Continuous	$I_C$	200
	1ms	$I_{C,pulse}$	400
	Continuous	$-I_C$	200
	1ms	$-I_{C,pulse}$	400
Max. Power Dissipation	$P_C$	720	W
Operating Temperature	$T_j$	+150	$^{\circ}C$
Storage Temperature	$T_{stg}$	-40 to +125	$^{\circ}C$
Net. Weight		340	g
Isolation Voltage	AC, 1min.	$V_{isol}$	2500
Screw Torque	Mounting *1	3.5 {35}	N · m
	Terminals *1	3.5 {35}	{kg · cm}

\*1 Recommendable Value 2.5 to 3.5 N·m {25 to 35 kg·cm} (M5)

#### ● Electrical Characteristics (T<sub>c</sub>=25°C)

Items	Symbols	Test Conditions	Min.	Typ.	Max.	Units
Zero Gate Voltage Collector Current	$I_{CES}$	$V_{GE}=0V$ $V_{CE}=600V$ $T_j=25^{\circ}C$			2.0	mA
		$V_{GE}=0V$ $V_{CE}=600V$ $T_j=125^{\circ}C$			—	mA
Gate-Emitter Leakage Current	$I_{GES}$	$V_{CE}=0V$ $V_{GE}=\pm 20V$			200	nA
Gate-Emitter Threshold Voltage	$V_{GE(th)}$	$V_{CE}=20V$ $I_C=200mA$	3.0		6.0	V
Collector-Emitter Saturation Voltage	$V_{CE(sat)}$	$V_{GE}=15V$ $I_C=200A$			2.5	V
Input Capacitance	$C_{ies}$	$V_{GE}=0V$		19000		pF
Output Capacitance	$C_{oes}$	$V_{CE}=10V$		—		
Reverse Transfer Capacitance	$C_{res}$	$f=1MHz$		—		
Turn-on Time	$t_{on}$	$V_{CC}=300V$			0.8	$\mu s$
	$t_r$	$I_C=200A$			0.6	
Turn-off Time	$t_{off}$	$V_{GE}=\pm 15V$			1.5	
	$t_f$	$R_G=9.1\Omega$			1.0	
Diode Forward On-Voltage	$V_F$	$I_F=200A$ , $V_{GE}=0V$			2.5	V
Reverse Recovery Time	$t_{rr}$	$I_F=200A$ , $-di/dt=600A/\mu s$ $V_{GE}=-10V$			300	ns

#### ● Thermal Characteristics

Items	Symbols	Test Conditions	Min.	Typ.	Max.	Units
Thermal Resistance	$R_{th(j-cl)}$	IGBT			0.174	$^{\circ}C/W$
	$R_{th(j-cl)}$	Diode			0.333	
	$R_{th(c-f)}$	With Thermal compound		0.025		

### ■ Outline Drawings

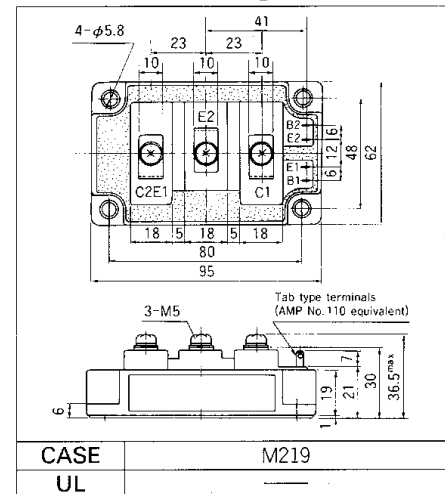

### ■ Equivalent Circuit Schematic

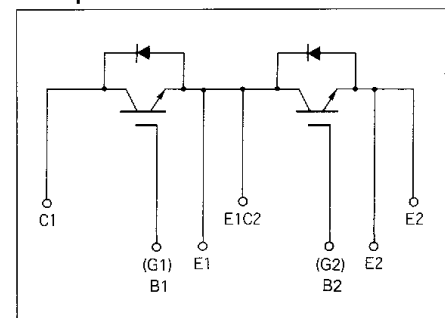

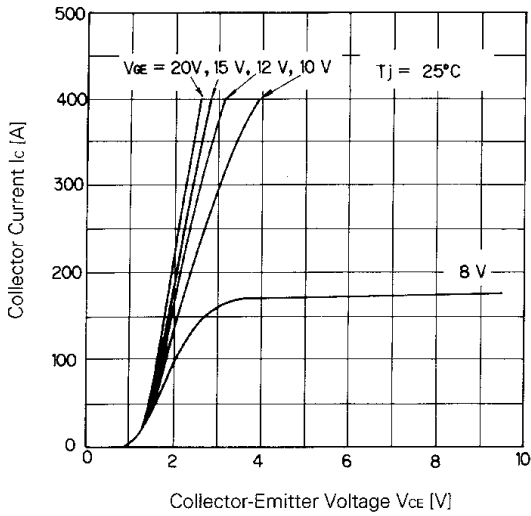

Collector Current vs. Collector-Emitter Voltage

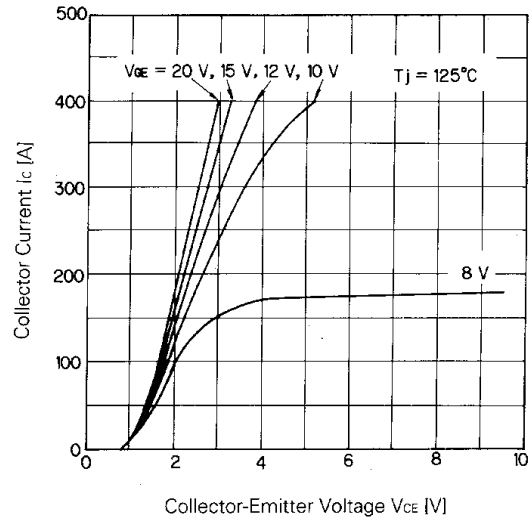

Collector Current vs. Collector-Emitter Voltage

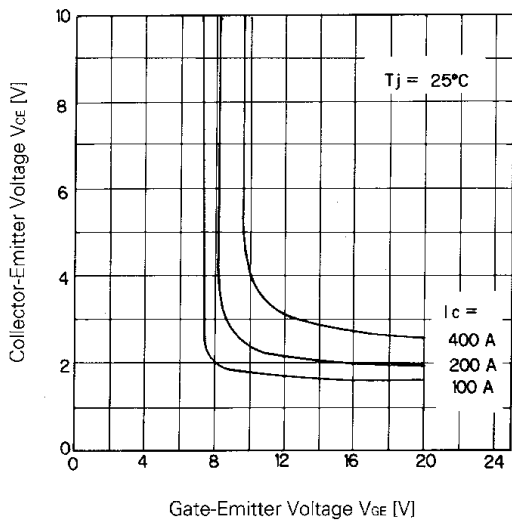

Collector-Emitter Voltage vs. Gate-Emitter Voltage

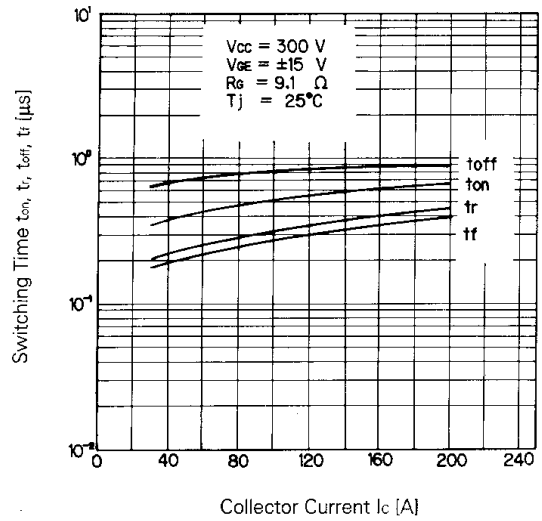

Switching Time

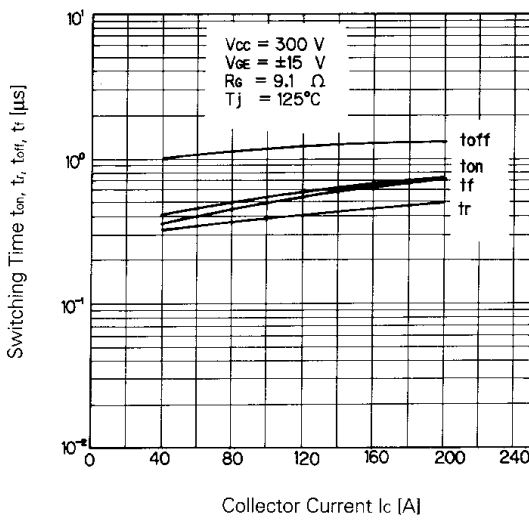

Switching Time

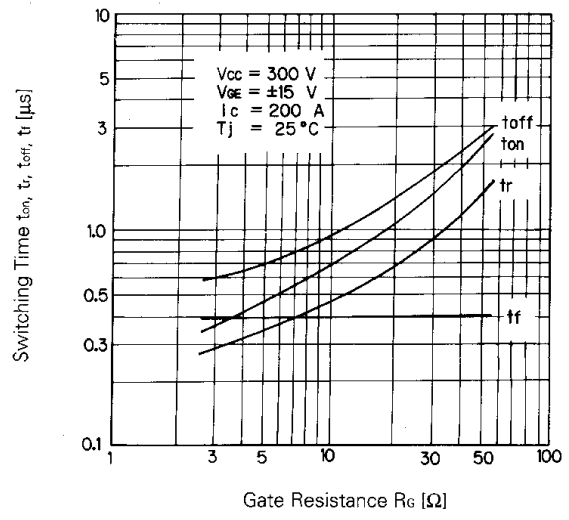

Switching Time-Gate Resistance

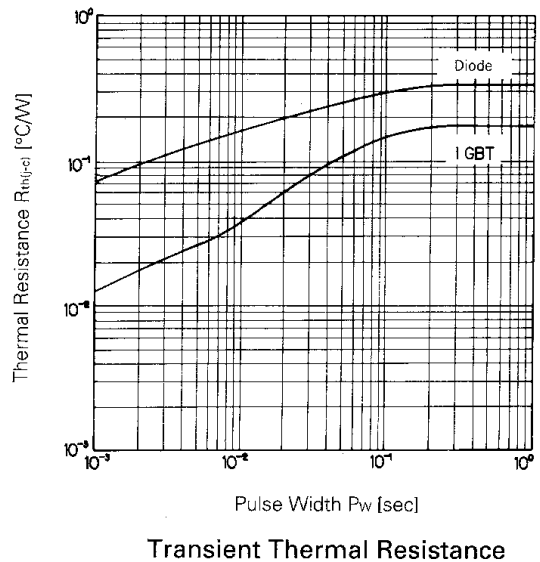
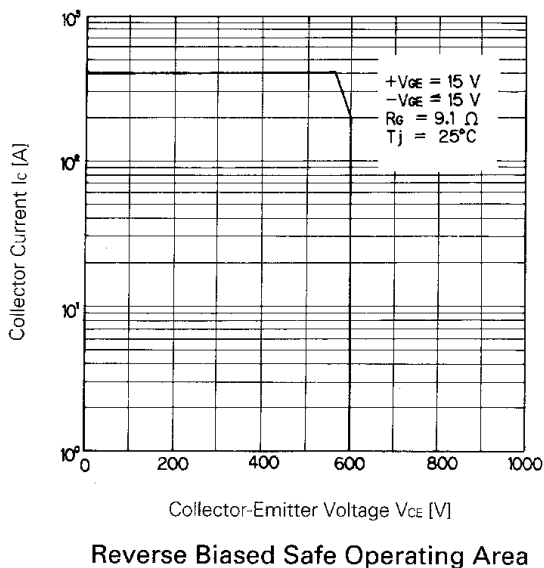
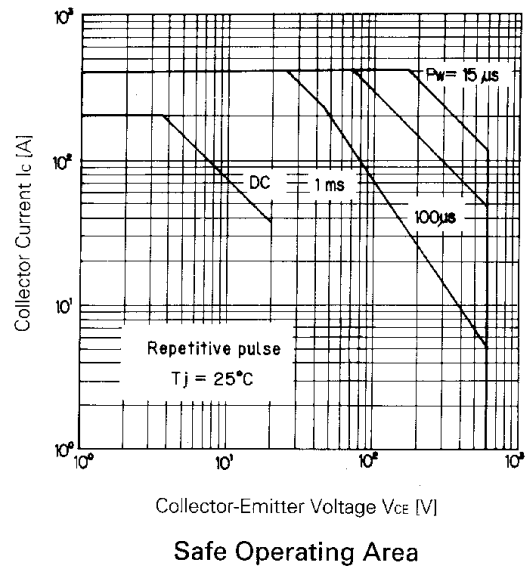
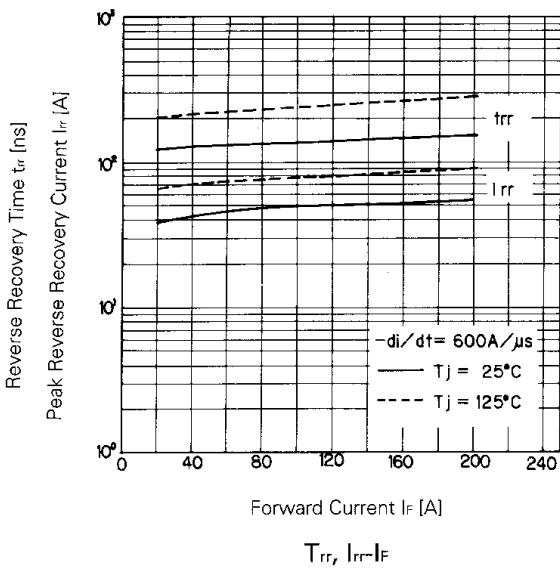
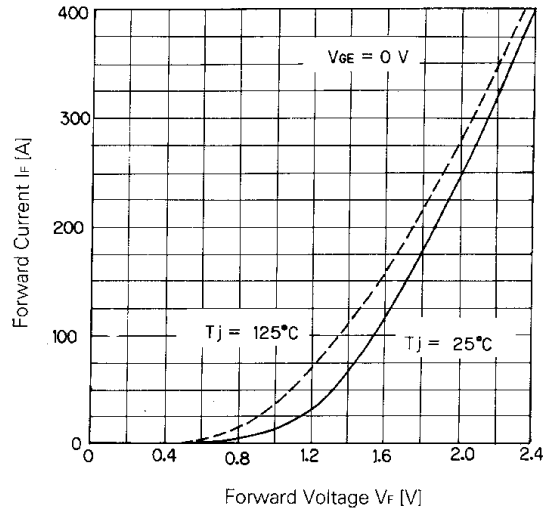
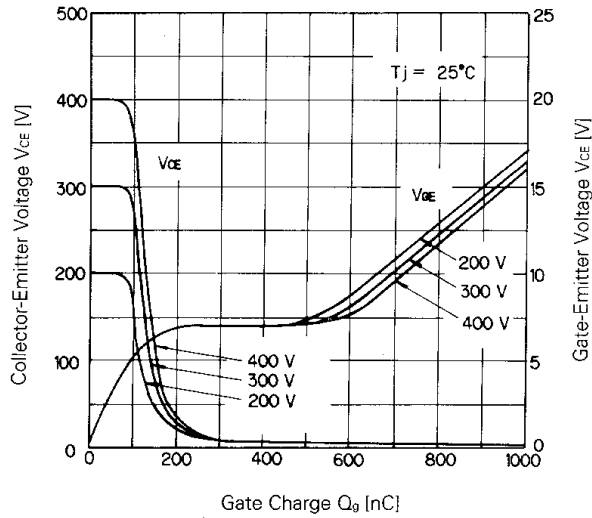

For more information, contact:

**Collmer Semiconductor, Inc.**

P.O. Box 702708

Dallas, TX 75370

972-733-1700

972-381-9991 Fax

<http://www.collmer.com>