

# S2D00R Series

## 2-3W, High Isolation DIP, Single & Dual Output DC/DC Converters

### Key Features

- Low Cost
- 3000VDC Isolation
- MTBF > 800,000 Hours
- 40mV P-P Ripple and Noise
- Input 5, 12 and 24VDC
- Output 5, 12, 15,  $\pm 12$  and  $\pm 15$ VDC
- Temperature Performance  $-25^{\circ}\text{C}$  to  $+71^{\circ}\text{C}$
- Short Circuit Protection
- UL 94V-0 Package Material
- Internal SMD Construction



Minimax's S2D00R Model 2–3W DC/DC's are specially designed to provide high levels of isolation 3000VDC in a low-profile 24-pin DIP package.

The series consists of 15 models with input voltages of 5V, 12V and 24VDC which offers regulated output voltages of 5V, 12V, 15V,  $\pm 12$ V and  $\pm 15$ VDC.

The S2D00R series is an excellent selection for a variety of applications including mixed analog/digital subsystems, railroad/transportation equipments, medical equipment subsystems, process/machine control equipments, automatic test instrumentation.

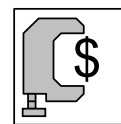

Low Cost

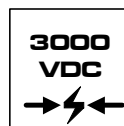

I/O Isolation

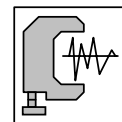

Low Noise

### Block Diagram

#### Single Output

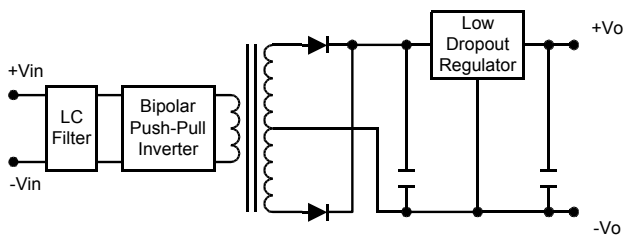

#### Dual Output

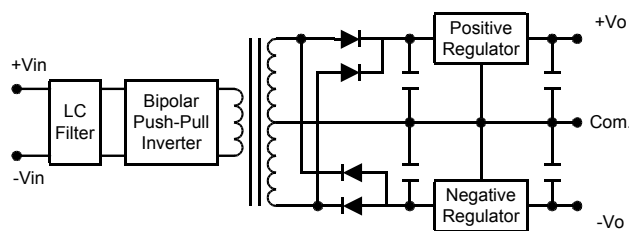

## Model Selection Guide

Model Number	Input Voltage	Output Voltage	Output Current		Input Current		Reflected Ripple Current	Efficiency
			Max.	Min.	@Max. Load	@No Load		@Max. Load
	VDC	VDC	mA	mA	mA (Typ.)	mA (Typ.)	mA (Typ.)	% (Typ.)
S2D01R	5 (4.75 ~ 5.25)	5	400	0	666	100	70	60
S2D02R		12	165		628			63
S2D03R		15	133		633			63
S2D04R		±12	±83		642			62
S2D05R		±15	±66		639			62
S2D06R	12 (10.8 ~ 13.2)	5	400	0	277	50	30	60
S2D07R		12	165		262			63
S2D08R		15	200		397			63
S2D09R		±12	±83		268			62
S2D10R		±15	±100		403			62
S2D11R	24 (21.6 ~ 26.4)	5	400	0	138	25	15	60
S2D12R		12	165		131			63
S2D13R		15	200		198			63
S2D14R		±12	±83		134			62
S2D15R		±15	±100		202			62

## Absolute Maximum Ratings

Parameter	Min.	Max.	Unit	
Input Surge Voltage (1000 mS)	5VDC Input Models	-0.7	7.5	VDC
	12VDC Input Models	-0.7	15	VDC
	24VDC Input Models	-0.7	30	VDC
Lead Temperature (1.5mm from case for 10 Sec.)	---	260	°C	
Internal Power Dissipation	---	3,000	mW	

Exceeding the absolute maximum ratings of the unit could cause damage.  
These are not continuous operating ratings.

## Notes :

- Specifications typical at Ta=+25°C, resistive load, nominal input voltage, rated output current unless otherwise noted.
- Transient recovery time is measured to within 1% error band for a step change in output load of 50% to 100%.
- Ripple & Noise measurement bandwidth is 0-20 MHz.
- All DC/DC converters should be externally fused at the front end for protection.
- Other input and output voltage may be available, please contact factory.
- Specifications subject to change without notice.

## Environmental Specifications

Parameter	Conditions	Min.	Max.	Unit
Operating Temperature	Ambient	-25	+71	°C
Operating Temperature	Case	-25	+90	°C
Storage Temperature		-40	+125	°C
Humidity		---	95	%
Cooling	Free-Air Convection			

## Input Specifications

Parameter	Model	Min.	Typ.	Max.	Unit
Input Voltage Range	5V Input Models	4.75	5	5.25	VDC
	12V Input Models	10.8	12	13.2	
	24V Input Models	21.6	24	26.4	
Reverse Polarity Input Current	All Models	---	---	0.5	A
Short Circuit Input Power		---	---	2500	mW
Input Filter		Pi Filter			

## Output Specifications

Parameter	Conditions	Min.	Typ.	Max.	Unit
Output Voltage Accuracy		---	±2.0	±4.0	%
Output Voltage Balance	Dual Output, Balanced Loads	---	±1.0	±3.0	%
Line Regulation	Vin=Min. to Max.	---	±0.2	±0.5	%
Load Regulation	Io=10% to 100%	---	±0.2	±0.5	%
Ripple & Noise (20MHz)		---	40	50	mV P-P
Ripple & Noise (20MHz)	Over Line, Load & Temp.	---	---	75	mV P-P
Ripple & Noise (20MHz)		---	---	5	mV rms
Over Load		120	---	---	%
Transient Recovery Time	50% Load Step Change	---	---	50	µs
Transient Response Deviation		---	---	±6	%
Temperature Coefficient		---	±0.01	±0.02	%/°C
Output Short Circuit	Continuous				

## General Specifications

Parameter	Conditions	Min.	Typ.	Max.	Unit
Isolation Voltage Rated	60 Seconds	3000	---	---	VDC
Isolation Voltage Test	Flash Tested for 1 Second	3300	---	---	VDC
Isolation Resistance	500VDC	1000	---	---	MΩ
Isolation Capacitance	100KHz, 1V	---	50	100	pF
Switching Frequency		40	80	---	KHz
MTBF	MIL-HDBK-217F @ 25°C, Ground Benign	800	---	---	K Hours

## Capacitive Load

Models by Vout	5V	12V	15V	±12V #	±15V #	Unit
Maximum Capacitive Load	470	470	470	220	220	µF

# For each output

## Input Fuse Selection Guide

5V Input Models	12V Input Models	24V Input Models
100mA Slow – Blow Type	750mA Slow – Blow Type	350mA Slow – Blow Type

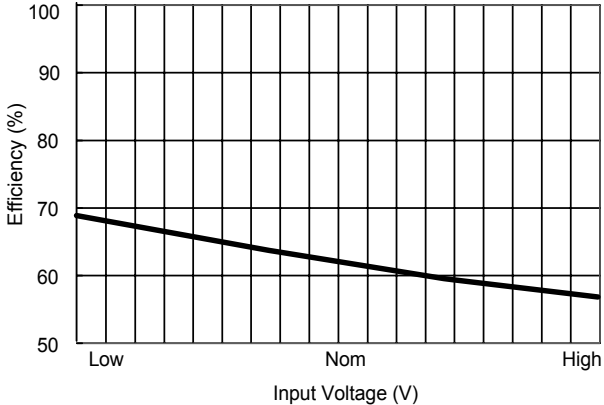

**Efficiency vs Input Voltage ( Single Output )**

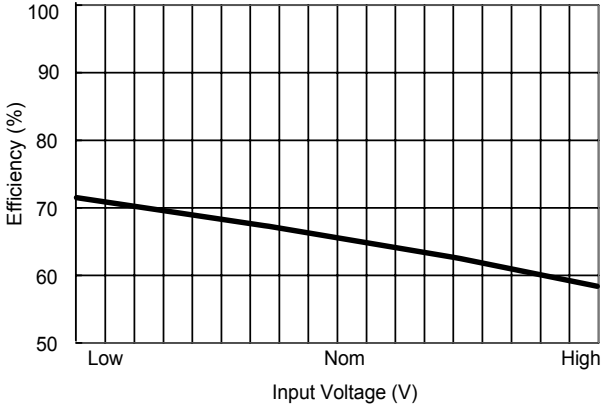

**Efficiency vs Input Voltage ( Dual Output )**

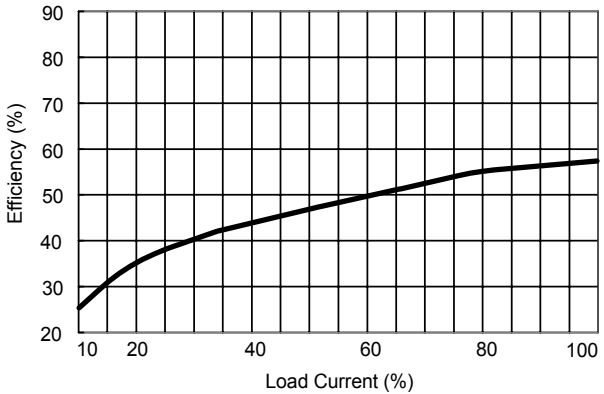

**Efficiency vs Output Load ( Single Output )**

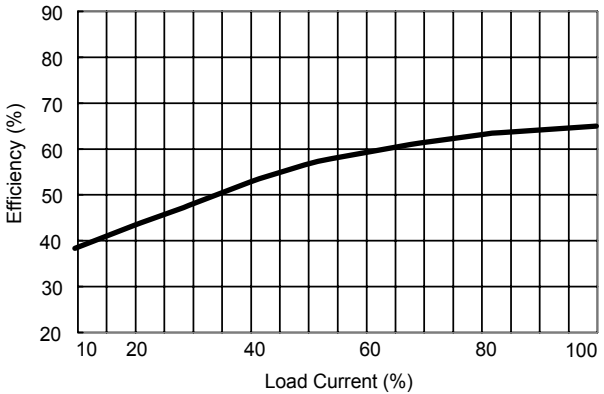

**Efficiency vs Output Load ( Dual Output )**

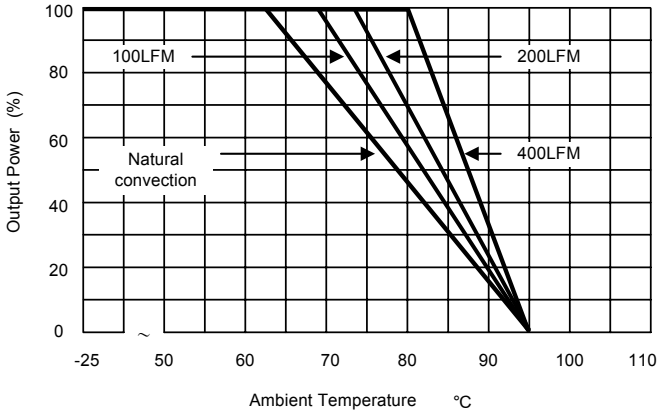

**Derating Curve ( Single output )**

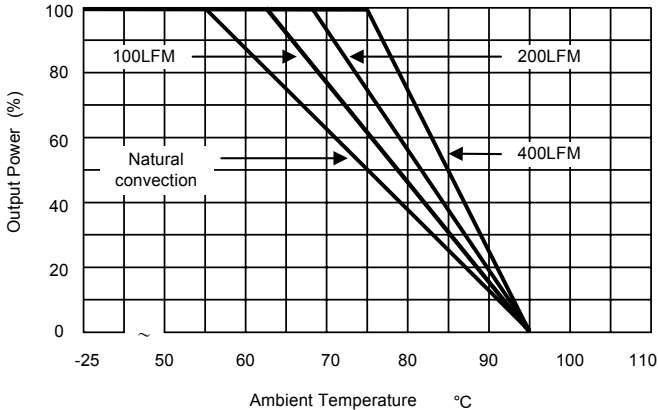

**Derating Curve ( Dual output )**

## Test Configurations

### Input Reflected-Ripple Current Test Setup

Input reflected-ripple current is measured with an inductor  $L_{in}$  (4.7uH) and  $C_{in}$  (220uF, ESR < 1.0Ω at 100 KHz) to simulate source impedance.

Capacitor  $C_{in}$ , offsets possible battery impedance. Current ripple is measured at the input terminals of the module, measurement bandwidth is 0–500 KHz.

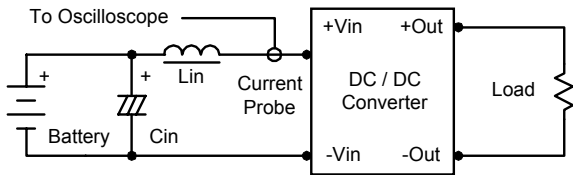

In applications where power is supplied over long lines and output loading is high, it may be necessary to use a capacitor at the input to ensure startup.

Capacitor mounted close to the power module helps ensure stability of the unit, it is recommended to use a good quality low Equivalent Series Resistance (ESR < 1.0Ω at 100 KHz) capacitor of a 2.2uF for the 5V input devices, a 1.0uF for the 12V input devices and a 0.47uF for the 24V and 48V devices.

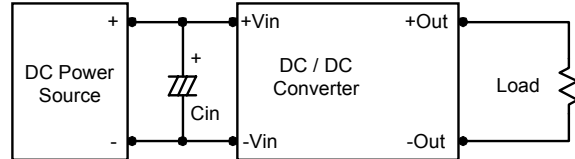

### Peak-to-Peak Output Noise Measurement Test

Use a  $C_{out}$  0.33uF ceramic capacitor. Scope measurement should be made by using a BNC socket, measurement bandwidth is 0–20 MHz. Position the load between 50 mm and 75 mm from the DC/DC Converter.

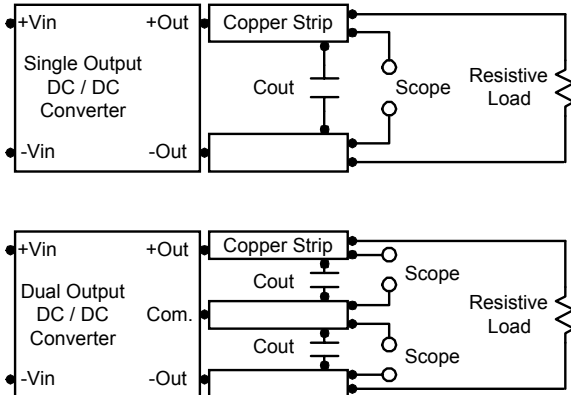

### Output Ripple Reduction

A good quality low ESR capacitor placed as close as practicable across the load will give the best ripple and noise performance.

To reduce output ripple, it is recommended to use 1.5uF capacitors at the output.

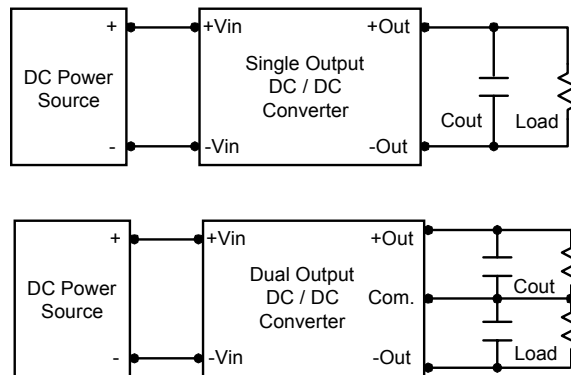

## Design & Feature Considerations

### Maximum Capacitive Load

The S2D00R series has limitation of maximum connected capacitance at the output.

The power module may be operated in current limiting mode during start-up, affecting the ramp-up and the startup time.

For optimum performance we recommend 220uF maximum capacitive load for dual outputs and 470uF capacitive load for single outputs.

The maximum capacitance can be found in the data sheet.

### Input Source Impedance

The power module should be connected to a low ac-impedance input source. Highly inductive source impedances can affect the stability of the power module.

### Thermal Considerations

Many conditions affect the thermal performance of the power module, such as orientation, airflow over the module and board spacing. To avoid exceeding the maximum temperature rating of the components inside the power module, the case temperature must be kept below 90°C.

The derating curves are determined from measurements obtained in an experimental apparatus.

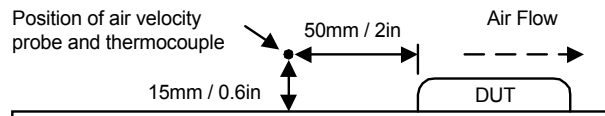

## Mechanical Dimensions

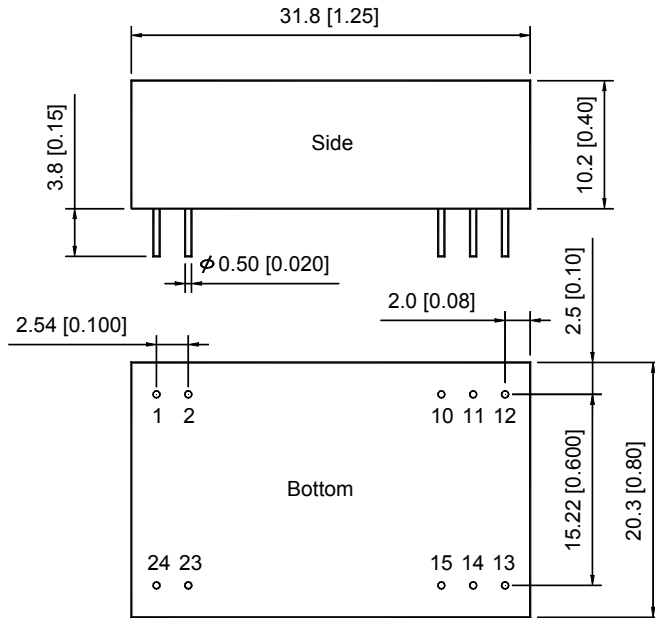

Tolerance	Millimeters	Inches
	X.X±0.25	X.XX±0.01
	X.XX±0.13	X.XXX±0.005
Pin	±0.05	±0.002

## Connecting Pin Patterns

Top View ( 2.54 mm / 0.1 inch grids )

### Single Output

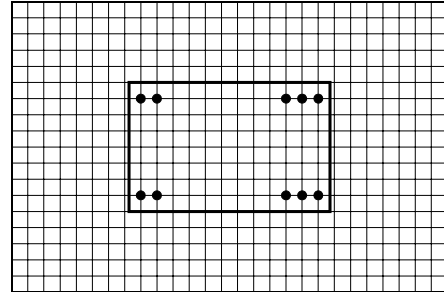

### Dual Output

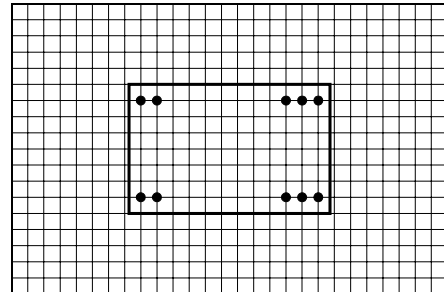

## Pin Connections

Pin	Single Output	Dual Output
1	+Vin	+Vin
2	+Vin	+Vin
10	NC	Common
11	NC	Common
12	-Vout	NC
13	+Vout	-Vout
14	NC	NC
15	NC	+Vout
23	-Vin	-Vin
24	-Vin	-Vin

NC: No Connection

## Physical Characteristics

**Case Size** : 31.8x20.3x10.2 mm  
1.25x0.80x0.40 inches

**Case Material** : Non-Conductive Black Plastic

**Weight** : 12.1g

**Flammability** : UL94V-0

The S2D00R converter is encapsulated in a low thermal resistance molding compound that has excellent resistance/electrical characteristics over a wide temperature range or in high humidity environments. The encapsulant and unit case are both rated to UL 94V-0 flammability specifications. Leads are tin plated for improved solderability.