

NTLGD3502N

Power MOSFET

20 V, 5.8 A/4.6 A Dual N-Channel,
DFN6 3x3 mm Package

Features

- Exposed Drain Package
- Excellent Thermal Resistance for Superior Heat Dissipation
- Low Threshold Levels
- Low Profile (< 1 mm) Allows It to Fit Easily into Extremely Thin Environments
- This is a Pb-Free Device

Applications

- DC-DC Converters (Buck and Boost Circuits)
- Power Supplies
- Hard Disk Drives

MOSFET I MAXIMUM RATINGS ($T_J = 25^\circ\text{C}$ unless otherwise noted)

Parameter	Symbol	Value	Unit		
Drain-to-Source Voltage	V_{DSS}	20	V		
Gate-to-Source Voltage	V_{GS}	± 20	V		
Continuous Drain Current (Note 1)	Steady State	$T_A = 25^\circ\text{C}$	4.3	A	
		$T_A = 85^\circ\text{C}$	3.0		
	$t \leq 5.0$ s	$T_A = 25^\circ\text{C}$	5.8		
Power Dissipation (Note 1)	Steady State	$T_A = 25^\circ\text{C}$	P_D	1.74	W
Pulsed Drain Current		$t \leq 10$ μs	I_{DM}	17.2	A
Operating Junction and Storage Temperature	T_J, T_{STG}	-55 to 150			$^\circ\text{C}$
Source Current (Body Diode)	I_S	1.6			A
Lead Temperature for Soldering Purposes (1/8" from case for 10 s)	T_L	260			$^\circ\text{C}$

MOSFET II MAXIMUM RATINGS ($T_J = 25^\circ\text{C}$ unless otherwise noted)

Parameter	Symbol	Value	Unit		
Drain-to-Source Voltage	V_{DSS}	20	V		
Gate-to-Source Voltage	V_{GS}	± 12	V		
Continuous Drain Current (Note 1)	Steady State	$T_A = 25^\circ\text{C}$	3.6	A	
		$T_A = 85^\circ\text{C}$	2.5		
	$t \leq 5.0$ s	$T_A = 25^\circ\text{C}$	4.6		
Power Dissipation (Note 1)	Steady State	$T_A = 25^\circ\text{C}$	P_D	1.74	W
Pulsed Drain Current		$t \leq 10$ μs	I_{DM}	13.8	A
Operating Junction and Storage Temperature	T_J, T_{STG}	-55 to 150			$^\circ\text{C}$
Source Current (Body Diode)	I_S	1.7			A
Lead Temperature for Soldering Purposes (1/8" from case for 10 s)	T_L	260			$^\circ\text{C}$

Stresses exceeding Maximum Ratings may damage the device. Maximum Ratings are stress ratings only. Functional operation above the Recommended Operating Conditions is not implied. Extended exposure to stresses above the Recommended Operating Conditions may affect device reliability.

1. Surface Mounted on FR4 Board using 1 in sq pad size (Cu area = 1.127 in sq [1 oz] including traces)
2. Surface Mounted on FR4 Board using the minimum recommended pad size of 30 mm², 1 oz. Cu



ON Semiconductor®

<http://onsemi.com>

MOSFET I

$V_{(BR)DSS}$	$R_{DS(on)}$ MAX	I_D MAX
20 V	60 m Ω @ 4.5 V	5.8 A

MOSFET II

$V_{(BR)DSS}$	$R_{DS(on)}$ MAX	I_D MAX
20 V	90 m Ω @ 4.5 V	4.6 A

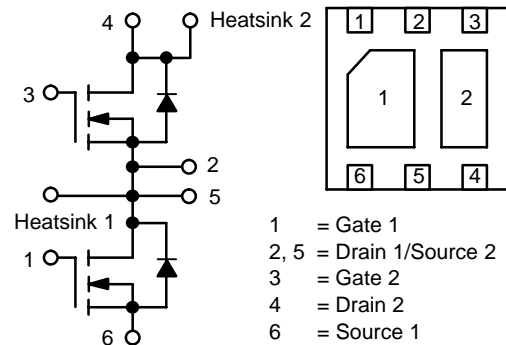

MARKING DIAGRAMS



DFN6
CASE 506AG

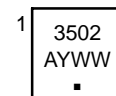

3502 = Specific Device Code
A = Assembly Location
Y = Year
WW = Work Week
▪ = Pb-Free Package

ORDERING INFORMATION

Device	Package	Shipping†
NTLGD3502NT1G	DFN6 (Pb-free)	3000/Tape & Reel
NTLGD3502NT2G	DFN6 (Pb-free)	3000/Tape & Reel

†For information on tape and reel specifications, including part orientation and tape sizes, please refer to our Tape and Reel Packaging Specifications Brochure, BRD8011/D.

NTLGD3502N

THERMAL RESISTANCE RATINGS

Parameter	Symbol	Max	Unit
Junction-to-Ambient – Steady State (Note 1)	$R_{\theta JA}$	72	°C/W
Junction-to-Ambient – $t \leq 5$ s (Note 1)	$R_{\theta JA}$	40	
Junction-to-Ambient – Steady State min Pad (Note 2)	$R_{\theta JA}$	110	
Junction-to-Ambient – Pulsed (25% duty cycle) min Pad (Note 2)	$R_{\theta JA}$	60	

MOSFET I ELECTRICAL CHARACTERISTICS ($T_J = 25^\circ\text{C}$ unless otherwise noted)

Parameter	Symbol	Test Conditions	Min	Typ	Max	Unit
-----------	--------	-----------------	-----	-----	-----	------

Off Characteristics

Drain-to-Source Breakdown Voltage	$V_{(BR)DSS}$	$V_{GS} = 0\text{ V}, I_D = 250\ \mu\text{A}$	20			V
Drain-to-Source Breakdown Voltage Temperature Coefficient	$V_{(BR)DSS}/T_J$	$I_D = 250\ \mu\text{A}$, ref to 25°C		10		mV/°C
Zero Gate Voltage Drain Current	I_{DSS}	$V_{GS} = 0\text{ V}, V_{DS} = 16\text{ V}$	$T_J = 25^\circ\text{C}$		1.0	μA
			$T_J = 125^\circ\text{C}$		10	
Gate-to-Source Leakage Current	I_{GSS}	$V_{DS} = 0\text{ V}, V_{GS} = \pm 20\text{ V}$			± 100	nA

On Characteristics (Note 3)

Gate Threshold Voltage	$V_{GS(TH)}$	$V_{GS} = V_{DS}, I_D = 250\ \mu\text{A}$	1.0	1.7	2.0	V
Negative Threshold Temperature Coefficient	$V_{GS(TH)}/T_J$			-4.4		mV/°C
Drain-to-Source On Resistance	$R_{DS(on)}$	$V_{GS} = 4.5\text{ V}, I_D = 4.3\text{ A}$		50	60	m Ω
Forward Transconductance	g_{FS}	$V_{DS} = 10\text{ V}, I_D = 4.0\text{ A}$		5.9		S

Charges, Capacitances & Gate Resistance

Input Capacitance	C_{ISS}	$V_{GS} = 0\text{ V}, f = 1\text{ MHz}, V_{DS} = 10\text{ V}$		250	480	pF
Output Capacitance	C_{OSS}			138	200	
Reverse Transfer Capacitance	C_{RSS}			52	90	
Total Gate Charge	$Q_{G(TOT)}$	$V_{GS} = 4.5\text{ V}, V_{DS} = 10\text{ V}; I_D = 4.3\text{ A}$ (Note 3)		2.9	4.0	nC
Gate-to-Source Charge	Q_{GS}			1.0		
Gate-to-Drain Charge	Q_{GD}			1.1		
Gate Resistance	R_G			1.5		

Switching Characteristics, $V_{GS} = 4.5\text{ V}$ (Note 4)

Turn-On Delay Time	$t_{d(ON)}$	$V_{GS} = 4.5\text{ V}, V_{DD} = 10\text{ V},$ $I_D = 4.3\text{ A}, R_G = 10\ \Omega$		7.0	12	ns
Rise Time	t_r			17.5	25	
Turn-Off Delay Time	$t_{d(OFF)}$			8.6	15	
Fall Time	t_f			3.3	5.0	

Drain-Source Diode Characteristics

Forward Diode Voltage	V_{SD}	$V_{GS} = 0\text{ V}, I_S = 1.6\text{ A}$	$T_J = 25^\circ\text{C}$		0.78	1.2	V
			$T_J = 125^\circ\text{C}$		0.63		
Reverse Recovery Time	t_{RR}	$V_{GS} = 0\text{ V}, d_{ISD}/d_t = 100\text{ A}/\mu\text{s},$ $I_S = 1.0\text{ A}$		16.7		ns	
Charge Time	t_a			8.2			
Discharge Time	t_b			8.5			
Reverse Recovery Charge	Q_{RR}			7.0		nC	

3. Pulse Test: pulse width $\leq 300\ \mu\text{s}$, duty cycle $\leq 2\%$

4. Switching characteristics are independent of operating junction temperatures

NTLGD3502N

MOSFET II ELECTRICAL CHARACTERISTICS (T_J = 25°C unless otherwise noted)

Parameter	Symbol	Test Conditions	Min	Typ	Max	Unit
Off Characteristics						
Drain-to-Source Breakdown Voltage	V _{(BR)DSS}	V _{GS} = 0 V, I _D = 250 μA	20			V
Drain-to-Source Breakdown Voltage Temperature Coefficient	V _{(BR)DSS} /T _J	I _D = 250 μA, ref to 25°C		22		mV/°C
Zero Gate Voltage Drain Current	I _{DSS}	V _{GS} = 0 V, V _{DS} = 16 V	T _J = 25°C		1	μA
			T _J = 125°C		10	
Gate-to-Source Leakage Current	I _{GSS}	V _{DS} = 0 V, V _{GS} = ±12 V			±100	nA

On Characteristics (Note 5)

Gate Threshold Voltage	V _{GS(TH)}	V _{GS} = V _{DS} , I _D = 250 μA	0.6		2.0	V
Negative Threshold Temperature Coefficient	V _{GS(TH)} /T _J			-2.8		mV/°C
Drain-to-Source On Resistance	R _{DS(on)}	V _{GS} = 4.5 V, I _D = 3.4 A		70	90	mΩ
		V _{GS} = 2.5 V, I _D = 1.7 A		95	120	
Forward Transconductance	g _{FS}	V _{DS} = 10 V, I _D = 3.4 A		6.7		S

Charges, Capacitances & Gate Resistance

Input Capacitance	C _{ISS}	V _{GS} = 0 V, f = 1 MHz, V _{DS} = 10 V		144	275	pF
Output Capacitance	C _{OSS}			67	125	
Reverse Transfer Capacitance	C _{RSS}			22	40	
Total Gate Charge	Q _{G(TOT)}	V _{GS} = 4.5 V, V _{DS} = 10 V; I _D = 3.4 A		2.1	5.0	nC
Threshold Gate Charge	Q _{G(TH)}			0.11		
Gate-to-Source Charge	Q _{GS}			0.42		
Gate-to-Drain Charge	Q _{GD}			0.7		

Switching Characteristics, V_{GS} = 4.5 V (Note 6)

Turn-On Delay Time	t _{d(ON)}	V _{GS} = 4.5 V, V _{DD} = 16 V, I _D = 3.4 A, R _G = 10 Ω		4.8	10	ns
Rise Time	t _r			13.6	25	
Turn-Off Delay Time	t _{d(OFF)}			9.0	20	
Fall Time	t _f			1.9	5.0	

Drain-Source Diode Characteristics

Forward Diode Voltage	V _{SD}	V _{GS} = 0 V, I _S = 1.7 A	T _J = 25°C		0.8	1.15	V
			T _J = 150°C		0.63		
Reverse Recovery Time	t _{RR}	V _{GS} = 0 V, d _{I_{SD}} /d _t = 100 A/μs, I _S = 1.0 A		12		ns	
Charge Time	t _a			8.0			
Discharge Time	t _b			4.0			
Reverse Recovery Charge	Q _{RR}			5.0			nC

5. Pulse Test: pulse width ≤ 300 μs, duty cycle ≤ 2%

6. Switching characteristics are independent of operating junction temperatures

NTLGD3502N

TYPICAL MOSFET I N-CHANNEL PERFORMANCE CURVES

($T_J = 25^\circ\text{C}$ unless otherwise noted)

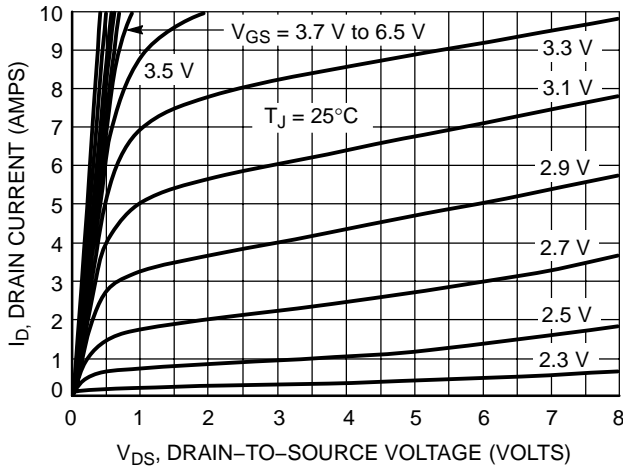

Figure 1. On-Region Characteristics

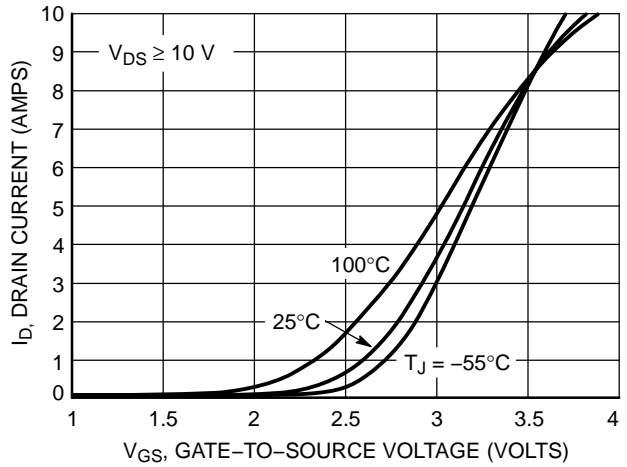

Figure 2. Transfer Characteristics

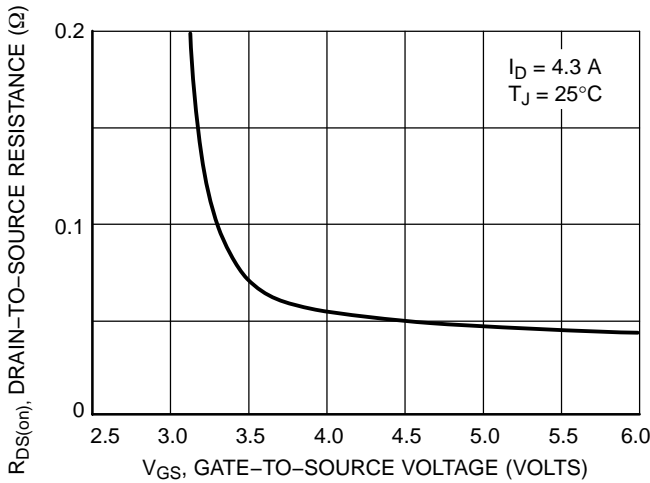

Figure 3. On-Resistance vs. Gate-to-Source Voltage

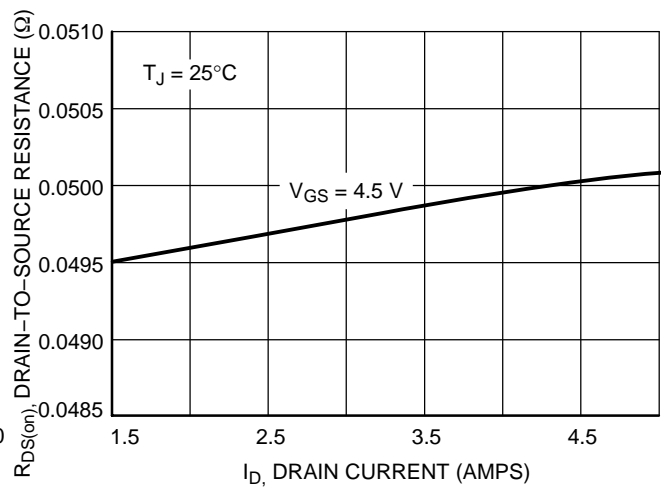

Figure 4. On-Resistance vs. Drain Current and Gate Voltage

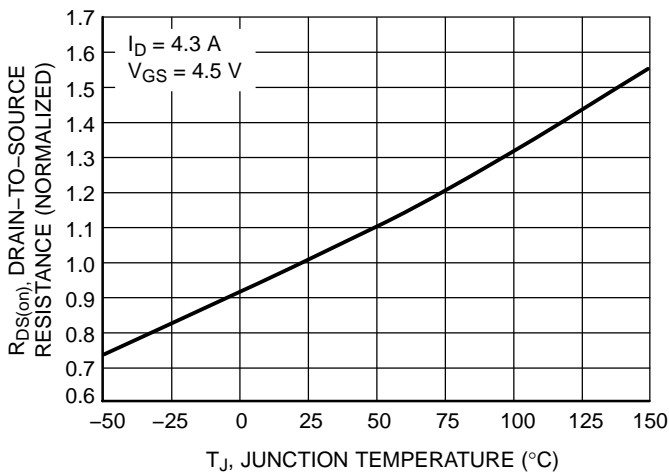

Figure 5. On-Resistance Variation with Temperature

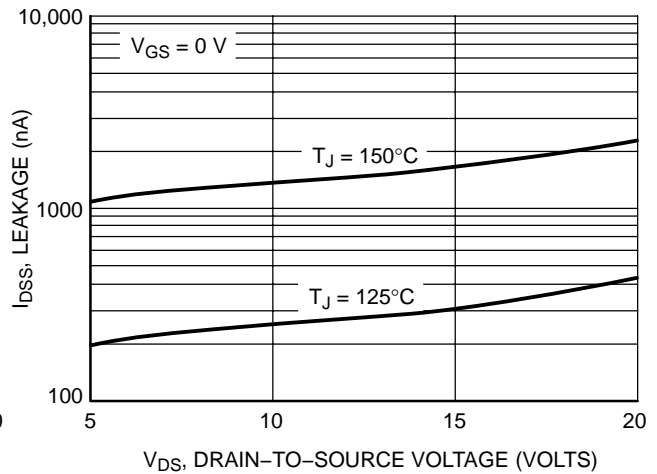

Figure 6. Drain-to-Source Leakage Current vs. Voltage

NTLGD3502N

TYPICAL MOSFET I N-CHANNEL PERFORMANCE CURVES

($T_J = 25^\circ\text{C}$ unless otherwise noted)

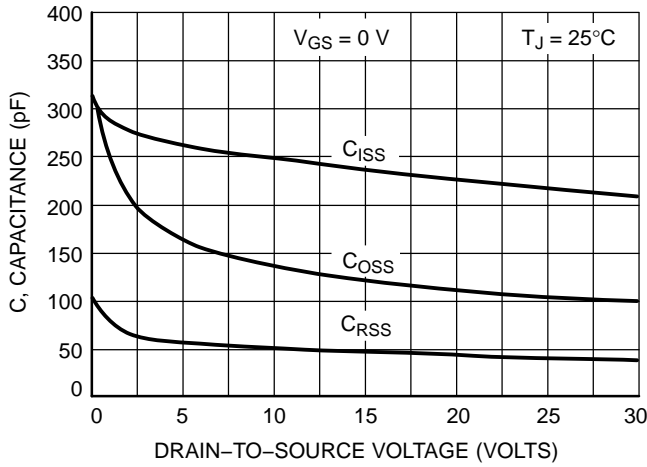

Figure 7. Capacitance Variation

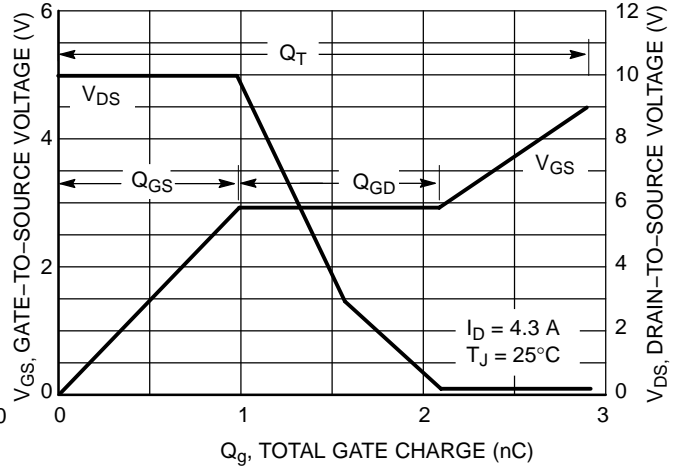

Figure 8. Gate-to-Source and Drain-to-Source Voltage vs. Total Charge

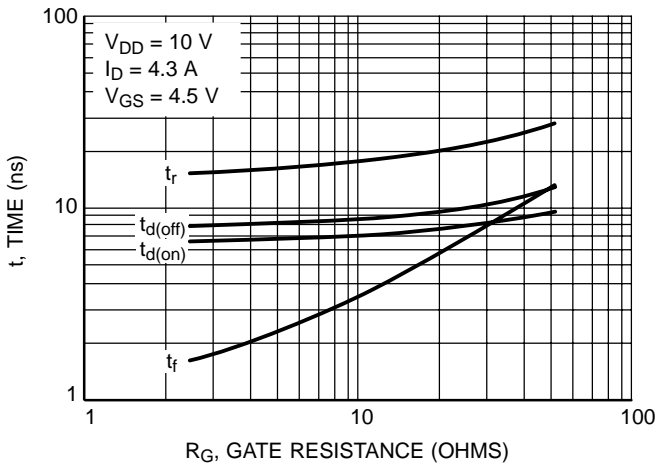

Figure 9. Resistive Switching Time Variation vs. Gate Resistance

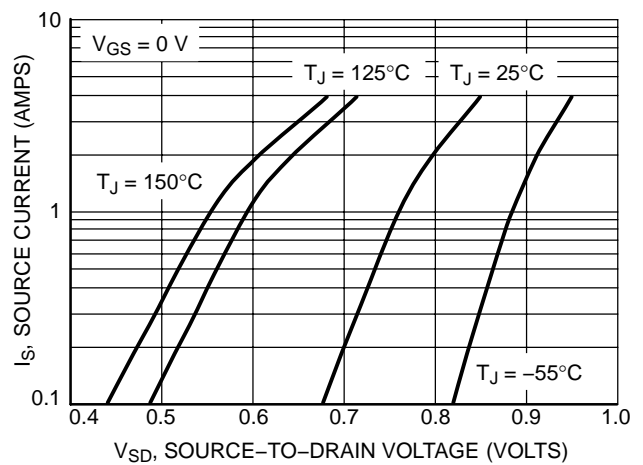

Figure 10. Diode Forward Voltage vs. Current

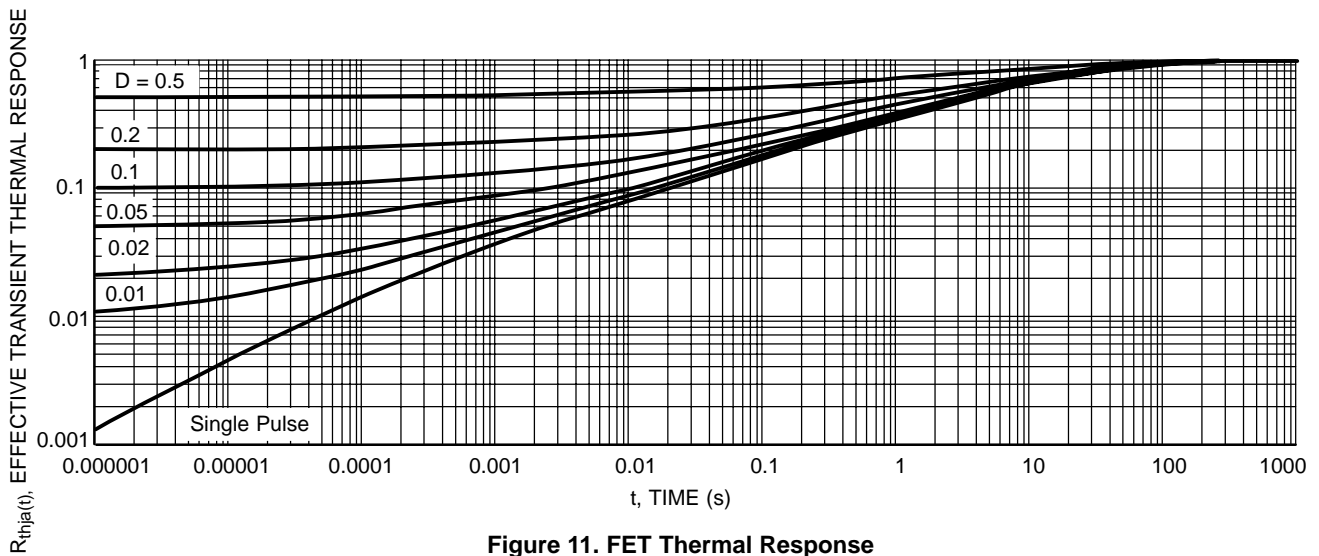

Figure 11. FET Thermal Response

NTLGD3502N

TYPICAL MOSFET II N-CHANNEL PERFORMANCE CURVES

($T_J = 25^\circ\text{C}$ unless otherwise noted)

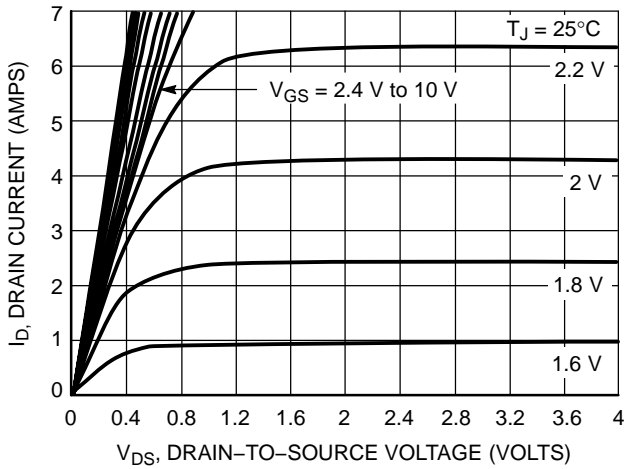

Figure 12. On-Region Characteristics

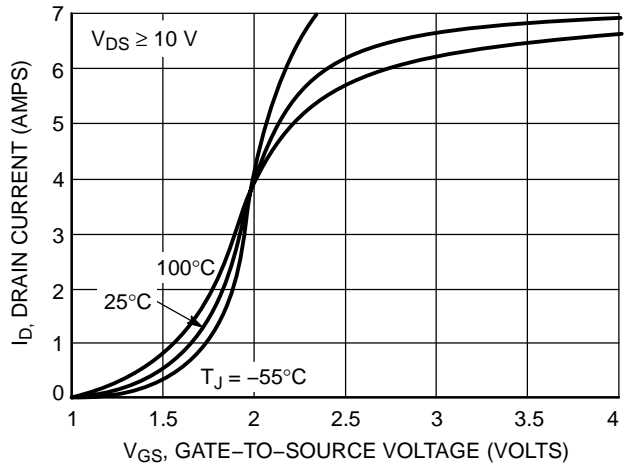

Figure 13. Transfer Characteristics

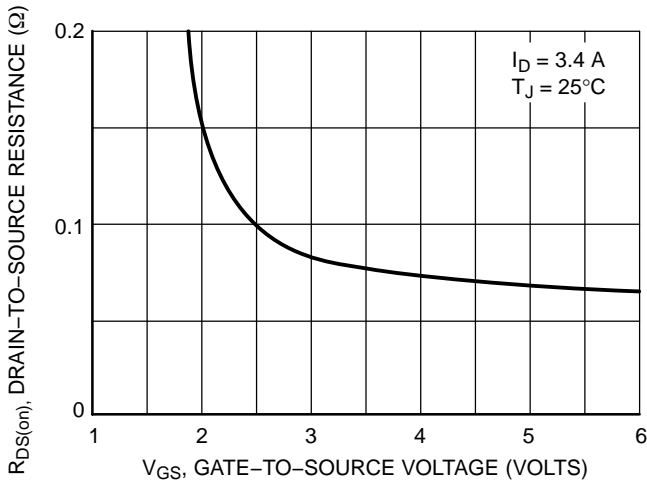

Figure 14. On-Resistance vs. Gate-to-Source Voltage

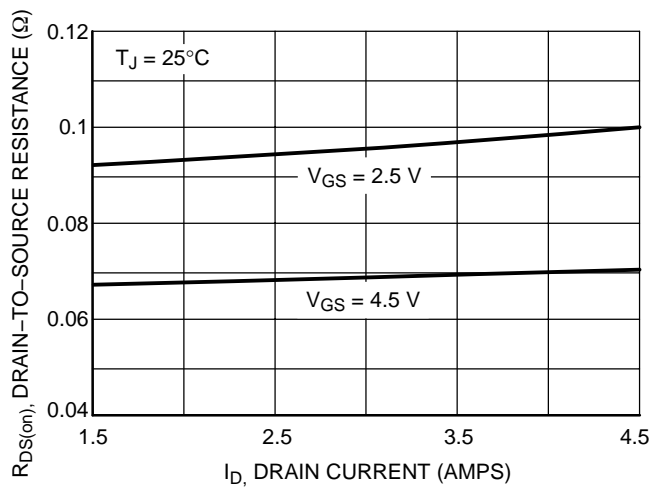

Figure 15. On-Resistance vs. Drain Current and Gate Voltage

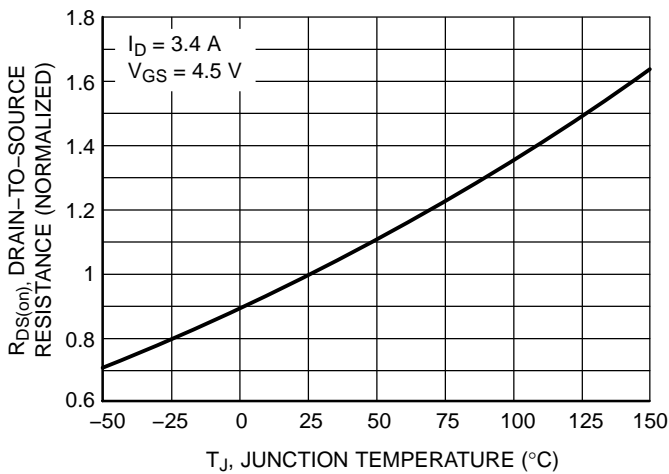

Figure 16. On-Resistance Variation with Temperature

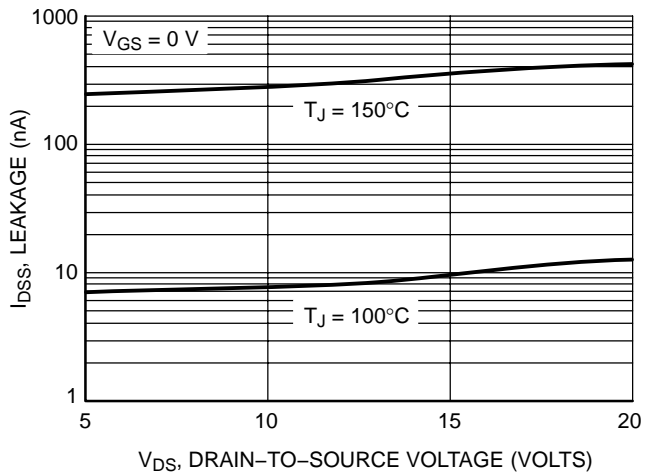

Figure 17. Drain-to-Source Leakage Current vs. Voltage

NTLGD3502N

TYPICAL MOSFET II N-CHANNEL PERFORMANCE CURVES

($T_J = 25^\circ\text{C}$ unless otherwise noted)

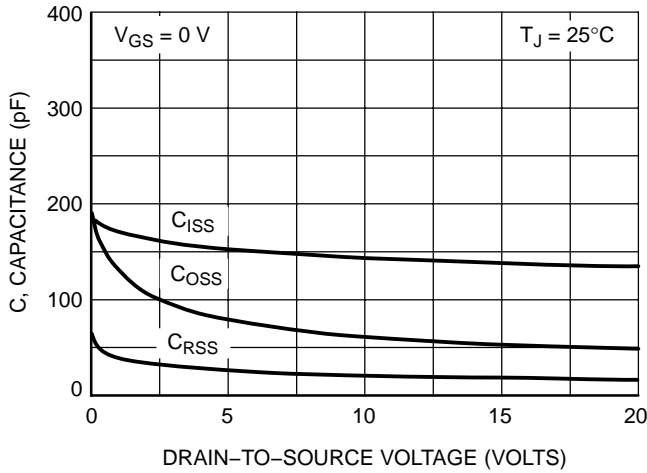

Figure 18. Capacitance Variation

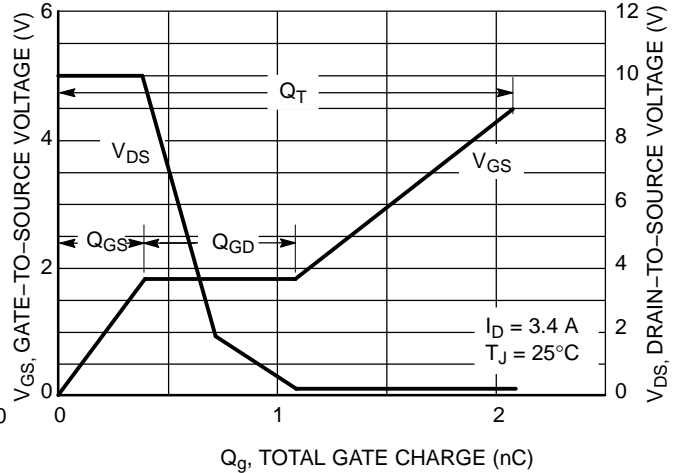

Figure 19. Gate-to-Source and Drain-to-Source Voltage vs. Total Charge

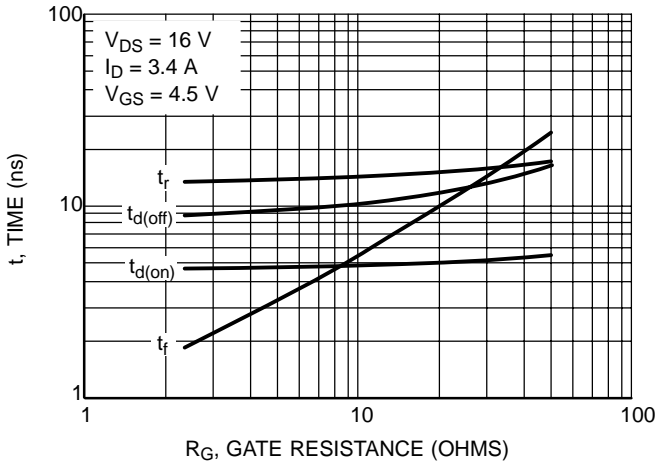

Figure 20. Resistive Switching Time Variation vs. Gate Resistance

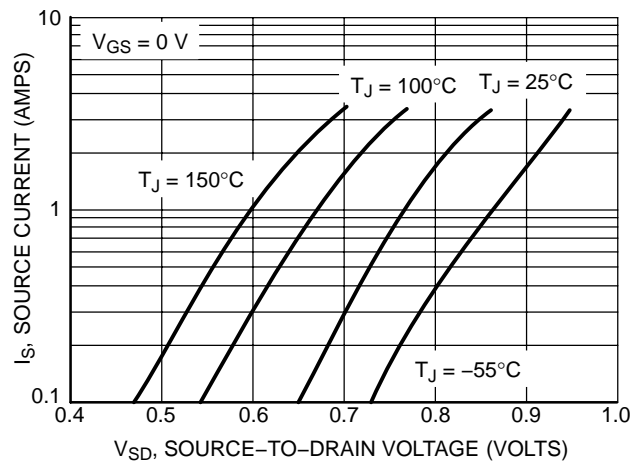

Figure 21. Diode Forward Voltage vs. Current

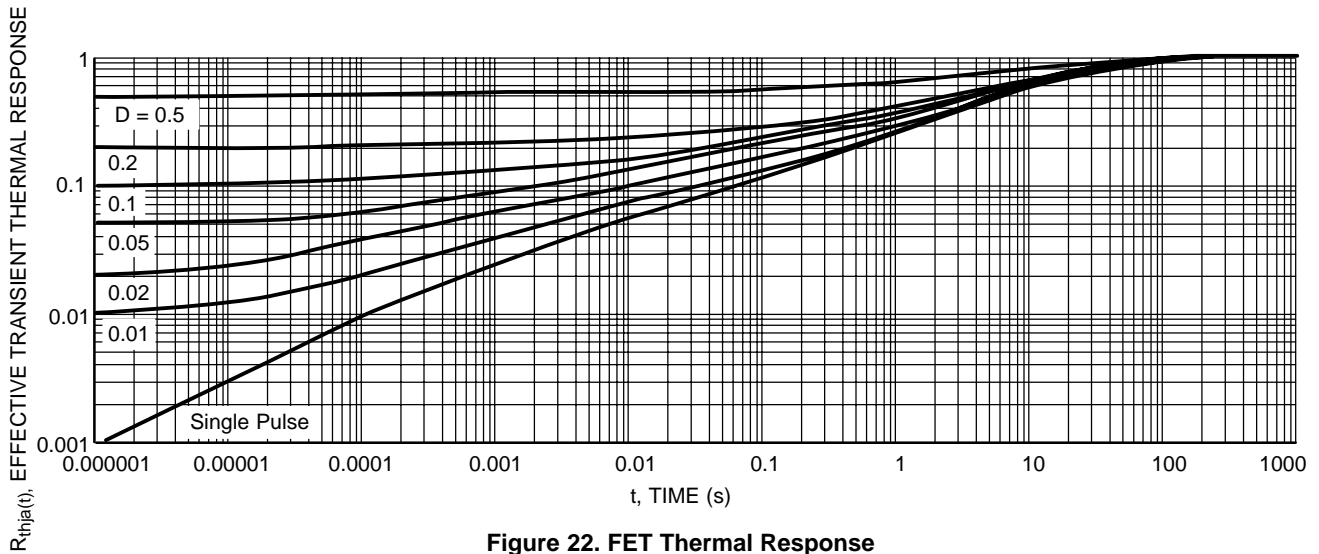
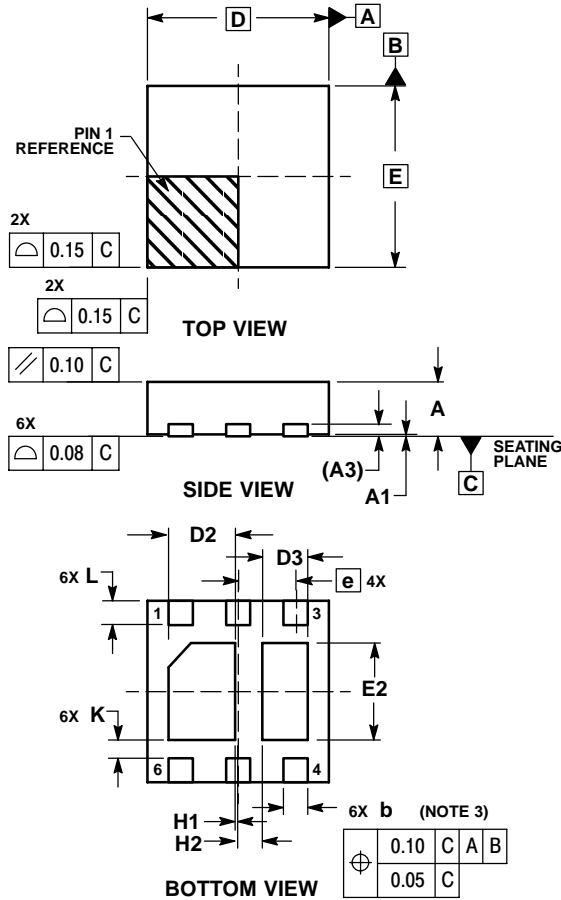

Figure 22. FET Thermal Response

NTLGD3502N

PACKAGE DIMENSIONS

DFN6 3*3 MM, 0.95 PITCH
CASE 506AG-01
ISSUE O



NOTES:

1. DIMENSIONS AND TOLERANCING PER ASME Y14.5M, 1994.
2. CONTROLLING DIMENSION: MILLIMETERS.
3. DIMENSION b APPLIES TO PLATED TERMINAL AND IS MEASURED BETWEEN 0.25 AND 0.30 MM FROM TERMINAL.
4. COPLANARITY APPLIES TO THE EXPOSED PAD AS WELL AS THE TERMINALS.

MILLIMETERS			
DIM	MIN	NOM	MAX
A	0.80	0.90	1.00
A1	0.00	0.03	0.05
A3	0.20 REF		
b	0.35	0.40	0.45
D	3.00 BSC		
D2	1.00	1.10	1.20
D3	0.65	0.75	0.85
E	3.00 BSC		
E2	1.50	1.60	1.70
e	0.95 BSC		
K	0.21	---	---
L	0.30	0.40	0.50
H1	0.05 REF		
H2	0.40 REF		

SOLDERING FOOTPRINT*

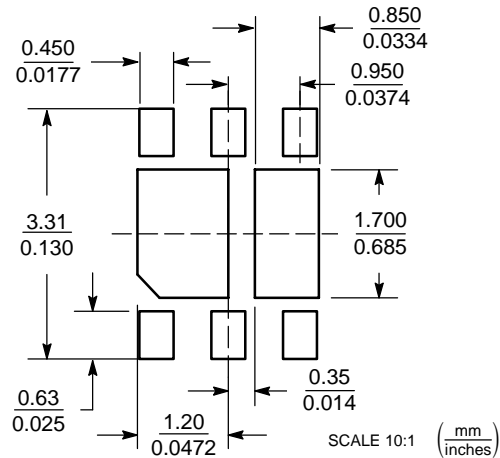

*For additional information on our Pb-Free strategy and soldering details, please download the ON Semiconductor Soldering and Mounting Techniques Reference Manual, SOLDERRM/D.

ON Semiconductor and are registered trademarks of Semiconductor Components Industries, LLC (SCILLC). SCILLC reserves the right to make changes without further notice to any products herein. SCILLC makes no warranty, representation or guarantee regarding the suitability of its products for any particular purpose, nor does SCILLC assume any liability arising out of the application or use of any product or circuit, and specifically disclaims any and all liability, including without limitation special, consequential or incidental damages. "Typical" parameters which may be provided in SCILLC data sheets and/or specifications can and do vary in different applications and actual performance may vary over time. All operating parameters, including "Typicals" must be validated for each customer application by customer's technical experts. SCILLC does not convey any license under its patent rights nor the rights of others. SCILLC products are not designed, intended, or authorized for use as components in systems intended for surgical implant into the body, or other applications intended to support or sustain life, or for any other application in which the failure of the SCILLC product could create a situation where personal injury or death may occur. Should Buyer purchase or use SCILLC products for any such unintended or unauthorized application, Buyer shall indemnify and hold SCILLC and its officers, employees, subsidiaries, affiliates, and distributors harmless against all claims, costs, damages, and expenses, and reasonable attorney fees arising out of, directly or indirectly, any claim of personal injury or death associated with such unintended or unauthorized use, even if such claim alleges that SCILLC was negligent regarding the design or manufacture of the part. SCILLC is an Equal Opportunity/Affirmative Action Employer. This literature is subject to all applicable copyright laws and is not for resale in any manner.

PUBLICATION ORDERING INFORMATION

LITERATURE FULFILLMENT:
Literature Distribution Center for ON Semiconductor
P.O. Box 5163, Denver, Colorado 80217 USA
Phone: 303-675-2175 or 800-344-3860 Toll Free USA/Canada
Fax: 303-675-2176 or 800-344-3867 Toll Free USA/Canada
Email: orderlit@onsemi.com

N. American Technical Support: 800-282-9855 Toll Free USA/Canada
Europe, Middle East and Africa Technical Support:
Phone: 421 33 790 2910
Japan Customer Focus Center
Phone: 81-3-5773-3850

ON Semiconductor Website: www.onsemi.com
Order Literature: <http://www.onsemi.com/orderlit>

For additional information, please contact your local Sales Representative